

PANELS

LAY-IN, SEMI-CONCEALED, CONCEALED ACCESS,
AND WALL PANELS

WOOD CEILINGS & WALLS PANELS



Ohio CAT & Peterbilt HQ, Broadview Heights, OH / Photo: © Studio 66 LLC

Elevate the design of a traditional suspended ceiling with this versatile collection of lay-in, semi-concealed, and concealed access panel options. Available in a variety of wood veneers and finishes, this collection of panels is offered in multiple configurations, including perforations, slots, and channels.

FEATURES AND BENEFITS

- Panel Sizes:
 - Lay-In* Panel Width up to 2', Length up to 6'
 - Semi-Concealed Panel Width up to 2', Length up to 4'
 - Concealed Access Panel Width up to 4', Length up to 8'
 - Wall Panel Width up to 4', Length up to 8'
- Choose from a variety of perforation, groove, and slot options for visual appeal and acoustic performance
- Select from a variety of fully-accessible installation options including lay-in, semi-concealed and concealed access
- Wide array of veneer species, cuts, and matches
- Additional custom materials, laminates, staining, sheening, and color matching are also available upon request
- Installation components are included when ordered through your local Sales Representative
- Achieve noise reduction coefficient up to 0.90 NRC
- FSC® available upon request
- Fully-engineered solutions are available through our Decoustics® portfolio. See Decoustics® Fully-Engineered Wood Panels Data Sheet for more information.

ATTRIBUTES



NRC
UP TO 0.90



CUSTOMIZATION
AVAILABLE



FIRE RATING:
CLASS A
PER ASTM E84
CAN/ULC-S102

LEED® v4

RECYCLED CONTENT

up to 80%

- ✓ EQ: Acoustic Performance (EQc)
- ✓ EQ: Low-Emitting Materials (EQc)¹
- ✓ MR: Regional Materials (MR Credits)²
- ✓ MR: Recycling (MRc)³
- ✓ MR: Raw Materials Sourcing (MRp2)⁴

¹ CertainTeed Wood Ceiling and Wall products meet General Emissions Evaluation per the CDPH standard; v1.2 2017

² 200% credit if project with 100 miles of manufacturing site

³ Wood products are recyclable and can be diverted from landfills and incinerators through recycling, recovery, reuse or salvage

⁴ Ask about FSC® availability (FSC-C151918)

LEED® is a registered trademark of the U.S. Green Building Council.

CERTIFICATIONS



FSC® AVAILABLE
ON REQUEST



LOW-EMITTING
MATERIALS / LOW VOC
(CDPH/EHLB/
STANDARD METHOD
VERSION 1.2, 2017)

ARCHITECTURAL

CertainTeed
SAINT-GOBAIN

COLORS AND FINISHES

A wide variety of veneer species, cuts, and matches are available. Additional custom materials, laminates, and color matching are also available upon request. Actual shades or grains may vary; request a sample for more accurate finish portrayal. Veneer species are shown with a clear finish and top coat. The three character species code is followed by the single character finish code. For example: Plain Slice Cherry (VPC) in an Auburn finish (H) is VPCH. Species below shown with clear finish (O).

VENEERS

Plain Slice Veneers



Quartered and Rift Cut Veneers

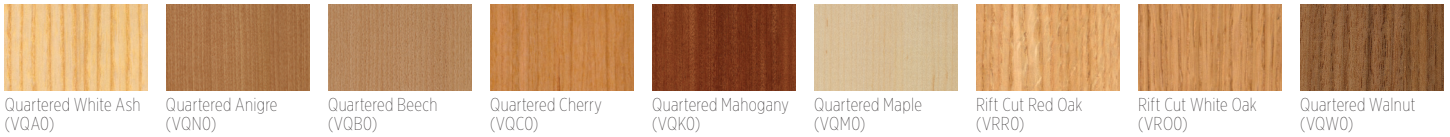

Reconstituted Quartered Veneers Engineered to deliver a uniform appearance across an installation



Bamboo Veneers



STAINS AND FINISHES

Clear finish available standard on all solid woods and veneers. All finishes and stains are available standard on Hemlock Mixed Grain (WHM) and Poplar (WPL) solid woods.

Standard Species and Stain Combinations

- Plain Slice Cherry (VPC): Merlot (I) and Auburn (H)
- Plain Slice Walnut (VPW): Coffee (C)
- Plain Slice Maple (VMP): Patina (A)
- Reconstituted Quartered Maple (RMC): Patina (A)



Finishes shown on Solid Poplar. Clear finish available standard on all products.



Additional veneer species, stains, color matching and finishes are available upon request. Please see catalog for more options or contact your local sales representative to get started.

INSTALLATION OPTIONS

CEILING

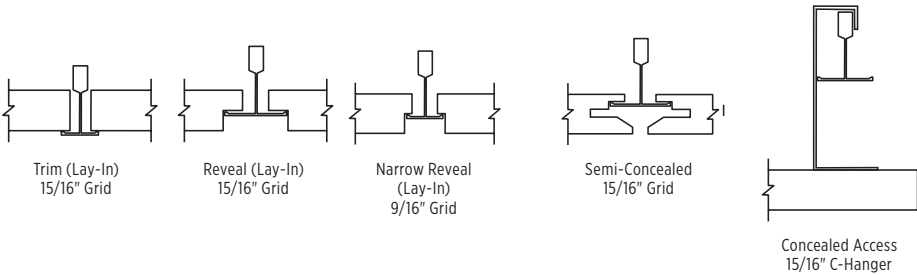

WALLS

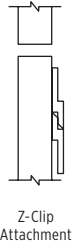

DIMENSIONAL OPTIONS

	WIDTH	LENGTH
Lay-In*	up to 2'	up to 6'
Semi-Concealed	up to 2'	up to 4'
Concealed Access	up to 4'	up to 8'
Walls	up to 4'	up to 8'

* 30" x 30" available

PERFORATION PATTERNS

UNPERFORATED

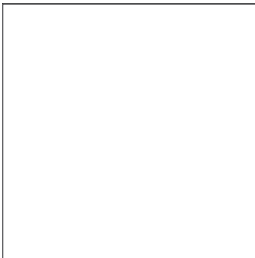

U1
Unperforated

PERFORATED

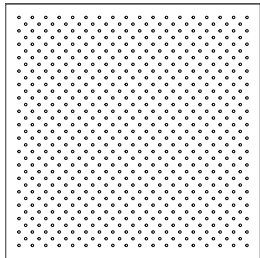

P3
6mm Round Hole
32mm O.C. Staggered

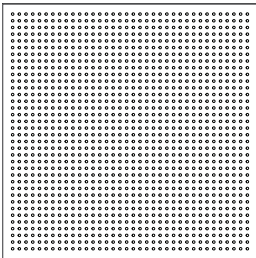

P4
6mm Round Hole
16mm O.C. Linear

SLOTTED

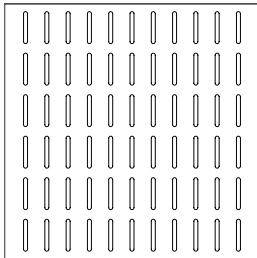

S5
3/8" x 3" Slot
2" O.C.

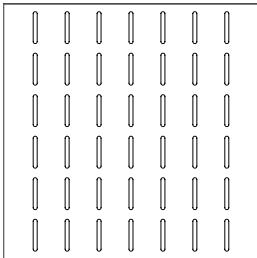

S6
3/8" x 3" Slot
3" O.C.

SOLO GROOVED

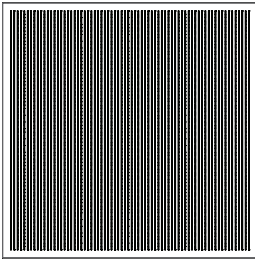

G4
2mm V-Groove
6mm O.C. (Solo 6)

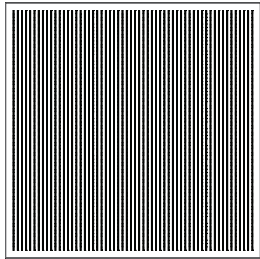

G1
2mm V-Groove
8mm O.C. (Solo 8)

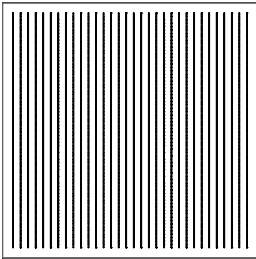

G2
2mm V-Groove
16mm O.C. (Solo 16)

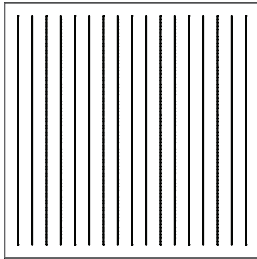



G3
2mm V-Groove
32mm O.C. (Solo 32)

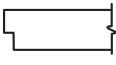

Additional custom and fully-engineered options including shapes, sizes, suspension and mounting systems, design returns and trims, and finishing options may be available for design flexibility. Contact your local sales representatives to get started.

STANDARD PRODUCT CONFIGURATIONS

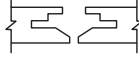
	DIMENSIONS (W x L x H) (in.)	SUSPENSION
NARROW REVEAL (9/16")		
	5005_____ 24" x 24" x 3/4"	9/16"
	5010_____ 24" x 48" x 3/4"	9/16"
	5015_____ 12" x 48" x 3/4"	9/16"
	5020_____ 12" x 72" x 3/4"	9/16"
	5025_____ 24" x 72" x 3/4"	9/16"
	5006_____ 30" x 30" x 3/4"	9/16"

	DIMENSIONS (W x L x H) (in.)	SUSPENSION
SEMI-CONDUCTOR (15/16")		
	5205_____ 24" x 24" x 3/4"	15/16"
	5210_____ 24" x 48" x 3/4"	15/16"
	5215_____ 12" x 48" x 3/4"	15/16"
CONCEALED ACCESS (C-HANGER 15/16")		
	5505_____ 24" x 48" x 3/4"	15/16"
	5510_____ 24" x 72" x 3/4"	15/16"
	5515_____ 12" x 96" x 3/4"	15/16"









UNDERSTANDING ITEM NUMBERS

To specify or order a specific product, include the 4-digit Item Number followed by the 2-character Visual Code and the 4-character Color Code.

Example: To order a 2" x 2" perforated (P3), narrow reveal panel in Narrow Cane Bamboo Natural, the item number would be **5005 P3 BNNO**

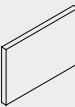
↓ ↓ ↓
 Item number Color Code Configuration Code

STANDARD TRIMS AND ACCESSORIES

INSTALLATION ACCESSORIES	PRODUCT NAME	COLOR	USE
	C-108 Semi-Concealed Safety Clip	Metal	Minimum four (4) safety clips per semi-concealed panel, two (2) clips per 2' side included with semiconcealed panel order; additional clips sold by the piece
	C-119 Concealed Access C-Hanger	Metal	C-hangers required for Concealed Access installation included with panel order: eight (8) per 96" panel, six (6) per 72", four (4) per 48"; additional components available by the piece as needed
	C-123 Narrow Reveal and Semi-Concealed Reversible Edge Clip	Metal	Reversible clip to replicate supporting edges on field modified panels; allows for a straight cut through the panel and does not require fixing the panel to the suspension system: two (2) clips required per foot, minimum three (3) clips per edge.
	1015T4___ 4" x 96" x 3/4" Trim	Veneer Finishes	4" perimeter trim; each 96" trim piece includes one (1) 3" Alignment Splice Plate (C-101) and four (4) 90 Degree Perimeter Trim Brackets (C-116) for trim installation
	1025T6___ 6" x 96" x 3/4" Trim	Veneer Finishes	6" perimeter trim; each 96" trim piece includes one (1) 3" Alignment Splice Plate (C-101) and four (4) 90 Degree Perimeter Trim Brackets (C-116) for trim installation
	1005T8___ 8" x 96" x 3/4" Trim	Veneer Finishes	8" perimeter trim; each 96" trim piece includes one (1) 3" Alignment Splice Plate (C-101) and four (4) 90 Degree Perimeter Trim Brackets (C-116) for trim installation*
	1105T2___ 2" x 96" x 3/4" Trim	Solid Wood Finishes	2" perimeter trim; each 96" trim piece includes one (1) 3" Alignment Splice Plate (C-101) and four (4) 90 Degree Perimeter Trim Brackets (C-116) for trim installation*
	1105T4___ 4" x 96" x 3/4" Trim	Solid Wood Finishes	4" perimeter trim; each 96" trim piece includes one (1) 3" Alignment Splice Plate (C-101) and four (4) 90 Degree Perimeter Trim Brackets (C-116) for trim installation*
	1105T6___ 6" x 96" x 3/4" Trim	Solid Wood Finishes	6" perimeter trim; each 96" trim piece includes one (1) 3" Alignment Splice Plate (C-101) and four (4) 90 Degree Perimeter Trim Brackets (C-116) for trim installation*

* Alternate suspension system mounted trim installation with Perimeter Clips (CTSPC-2) available, consult with your Technical Sales Specialist or Project Manager for more information

INSTALLATION EXAMPLES

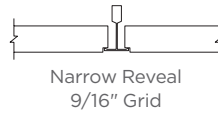
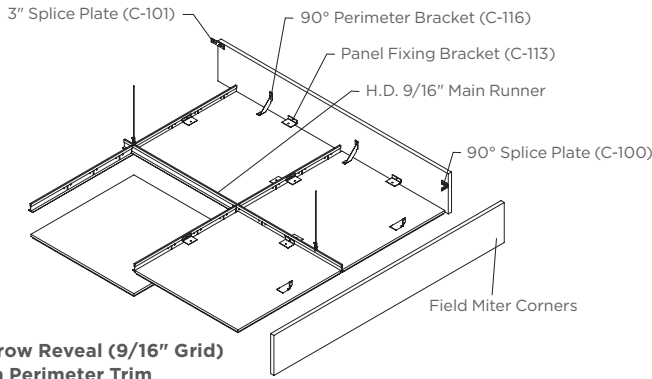

Narrow Reveal (9/16" Grid) with Perimeter Trim

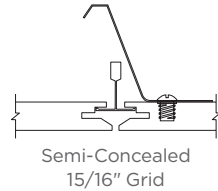
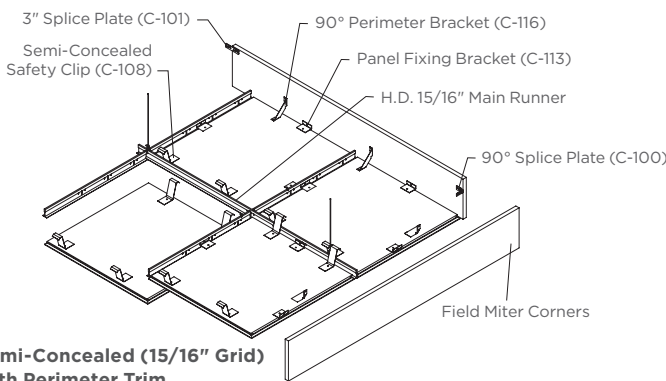

Semi-Concealed (15/16" Grid) with Perimeter Trim

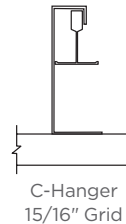
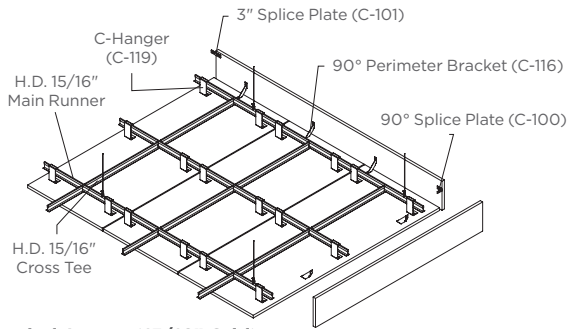

Concealed Access (15/16" Grid) with Perimeter Trim

PHYSICAL DATA

MATERIAL

Fire-retardant composite wood

WEIGHT

2.0 – 4.0 lbs./sq. ft. (typical system weight)
Varies by Configuration

FIRE CLASS

ASTM E84 (Class A) and CAN/ULC-S102
Flame Spread: 25 or less
Smoke Developed: 50 or less

SEISMIC INSTALLATION

See installation details for seismic area installation information. Per IBC the maximum system weight for ceilings installed with Acoustical Suspension Systems in Seismic Design Categories C, D, E, and F is 4.0 lbs./sq. ft. when referencing ICC-ES ESR-3336. System weights greater than 4.0 lbs./sq. ft. may require local Professional Engineering services.

APPLICATION CONSIDERATIONS

Wood panels must be acclimatized for 72 hours prior to installation. Maintain relative humidity between 25% and 55% and temperature between 50°F and 86°F (10°C and 30°C) for the life of the product.

Wood is a natural material with varying grain and color characteristics. Characteristics may vary from panel to panel. For a more uniform appearance, consider reconstituted veneer options.

VISUAL CONSIDERATIONS

Surface Finish: clear or tinted topcoat with 20% sheen

WARRANTY

Full warranty information can be found at certainteed.com/warranty

ACOUSTICAL PERFORMANCE

		125	250	500	1000	2000	4000	NRC	CAC
CEILING/PLENUM (E-400)*									
G2 (Solo 16)	Ceiling/Plenum (E-400)	0.57	0.69	0.67	0.80	0.91	0.86	0.75	
G3 (Solo 32)	Ceiling/Plenum (E-400)	0.49	0.51	0.46	0.54	0.63	0.65	0.55	
G4 (Solo 6)	Ceiling/Plenum (E-400)	0.70	0.77	0.78	0.92	1.02	0.97	0.85	
G1 (Solo 8)	Ceiling/Plenum (E-400)	0.66	0.74	0.72	0.82	0.92	0.87	0.80	
P3	Ceiling/Plenum (E-400)	0.67	0.57	0.46	0.39	0.31	0.31	0.45	28
P4	Ceiling/Plenum (E-400)	0.72	0.63	0.70	0.73	0.67	0.67	0.70	23
S5	Ceiling/Plenum (E-400)	0.84	0.86	0.70	0.66	0.46	0.53	0.65	22
S6	Ceiling/Plenum (E-400)	0.94	0.77	0.64	0.52	0.37	0.43	0.60	25
WALL/FLUSH MOUNT (A-MOUNT)*									
G2 (Solo 16)	Wall/Flush Mount (A-Mount)	0.34	0.62	0.81	0.80	0.81	0.81	0.75	
G3 (Solo 32)	Wall/Flush Mount (A-Mount)	0.44	0.47	0.54	0.52	0.55	0.56	0.50	
G4 (Solo 6)	Wall/Flush Mount (A-Mount)	0.29	0.59	0.93	0.95	0.91	0.88	0.85	
G1 (Solo 8)	Wall/Flush Mount (A-Mount)	0.30	0.61	0.86	0.83	0.83	0.81	0.80	

* Sound absorption achieved with the addition of acoustical fleece, fabric, and/or infill; results shown are achieved with 1" fiberglass acoustic infill; ceiling attenuation class results shown without acoustical infill or additional sound blocking materials E-400 and A Mount per ASTM C423-17.



CertainTeed ARCHITECTURAL

METAL • WOOD • FELT • FIBERGLASS & MINERAL FIBER • GYPSUM • SUSPENSION & INTEGRATED SYSTEMS
20 Moores Road, Malvern, PA 19355 800-387-3809 Technical Sales 216-228-6650 Project Support certainteed.com/architectural