



Control Room: Police, Fire & Ambulance, Amsterdam, The Netherlands

Stretch Metal Hook-On Ceilings offers architects contemporary design freedom to create an optical contrast to other surrounding materials. The choice of patterns, materials and colours provides the designer with an opportunity to create a unique appearance on every project.

## FEATURES AND BENEFITS

- Panel sizes:
  - 30.48 cm, 45.72 m, 60.96 cm (12", 18", 24") wide x 60.96 cm - 182.88 cm (24" - 72") max length (LS6, LS8, LS10, LS12, LS16, LD10, LD16)
  - 30.48 cm, 45.72 m, 60.96 cm, 76.20 cm (12", 18", 24", 30") wide x 60.96 cm - 243.84 cm (24" - 96") max length (LD20 Rotterdam, LD28 Moscow, LD43 Paris, LD62 Dubai, LD85 New York)
- Panel options:
  - Folded and Flat:
    - LS6, LS8, LS10, LS12, LS16, LD10, LD16, LD20 Rotterdam, LD28 Moscow
  - Flat only:
    - LD43 Paris, LD62 Dubai, LD85 New York
- Compatible with industry standard lighting, HVAC, speaker, fire safety, and security services
- Easy access to the plenum
- Highly versatile material that can provide excellent acoustical benefits and an array of visual effects to a ceiling
- Uniform aesthetics are created with square and diamond mesh patterns with an openness area ranging from 36-70%

## ATTRIBUTES



**FIRE RATING:**  
SMOKE DEVELOPED ≤ 50 AND  
FLAME SPREAD ≤ 25  
AS PER CAN/ULC S102



**SEISMIC RATING:**  
CLASSES A, B, C, D, E, F



**CUSTOMIZATION  
AVAILABLE**

## LEED® v4

RECYCLED  
CONTENT

Steel - 25%  
Aluminum - up to 92%

- ✓ EA: Optimize Energy Performance
- ✓ MR: Building Product Disclosure
- ✓ EQ: Low-Emitting Materials
- ✓ EQ: Indoor Air Quality Assessment
- ✓ EQ: Daylight
- ✓ EQ: Acoustic Performance

LEED® is a registered trademark of the U.S. Green Building Council.

## CERTIFICATIONS



**GREENGUARD:  
GOLD CERTIFIED**



**EPD AVAILABLE**

## COLOURS AND FINISHES

A wide range of RAL and NCS colours and custom colours to match are available upon request. See website for the most up to date information and to order samples. Colours are for illustration purposes only.

### STANDARD PAINT COLOURS

Powder-coat finish.

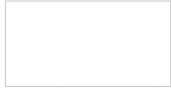

**Signal White 7003P**  
RAL 9003 Signal White  
Matte/Eggshell Gloss 5-15%

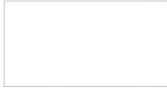

**Cotton White 0280**  
RAL 9010 Pure White  
Matte/Eggshell Gloss 5-15%

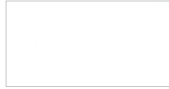

**Traffic White 5016P**  
RAL 9016 Traffic White  
Matte/Eggshell Gloss 5-15%



**Natural 7163P**  
RAL 9006 White Aluminum  
Matte/Eggshell Gloss 5-15%



**Atlantic Grey 1117**  
RAL 9007 Grey Aluminum  
Matte/Eggshell Gloss 5-15%



**Starless Black 5000P**  
RAL 9005 Jet Black  
Matte/Eggshell Gloss 5-15%



**Raven Black 5030P**  
RAL 9005 Jet Black  
Satin-Gloss 25-40%



**Sable Black 5060P**  
RAL 9005 Jet Black  
Semi-Gloss 40-70%



**Wet Glass Black 5095P**  
RAL 9005 Jet Black  
Full Gloss 70-90%

### CUSTOM COLOURS



Premium Custom Colours

## MESH TYPES

All types available in steel. Aluminum on request. All meshes shown 1:4 scale. Note: Mesh shapes S = Square and D = Diamond.

### Micro Mesh Square (Folded & Flat)

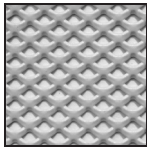

LS6  
Open area: 36%

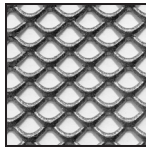

LS8  
Open area: 54%

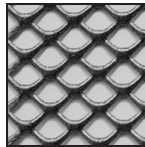

LS10  
Open area: 57%

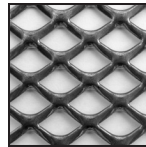

LS12  
Open area: 70%

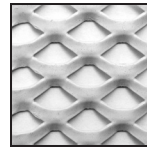

LS16  
Open area: 46%

### Micro Mesh Diamond (Folded & Flat)

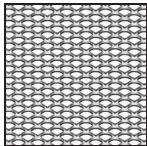

LD10  
Open area: 45%

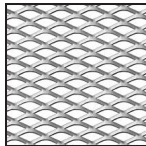

LD16  
Open area: 47%

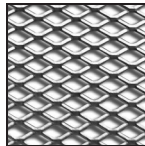

LD20 Rotterdam  
Open area: 55%

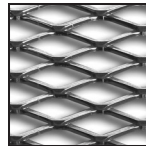

LD28 Moscow  
Open area: 55%

### Macro Mesh Diamond (Flat only)

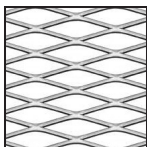

LD43 Paris  
Open area: 60%

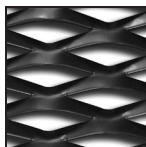

LD62 Dubai  
Open area: 36%



LD85 New York  
Open area: 48%

## INSTALLATION EXAMPLES

### Typical Isometrics

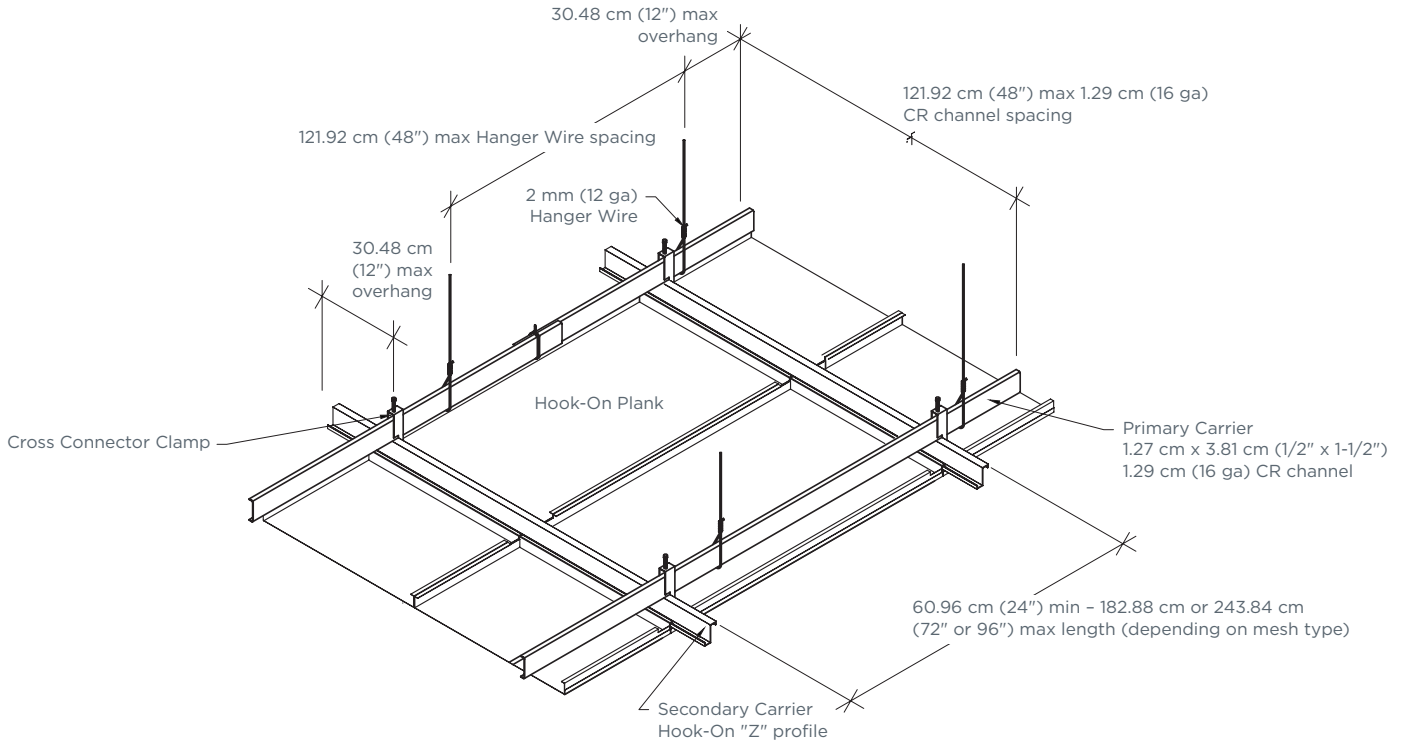

### Typical Sections

#### Panel Options

**Folded** (where the welded stretch metal runs up the stretch metal hook-on panel framed return legs.)

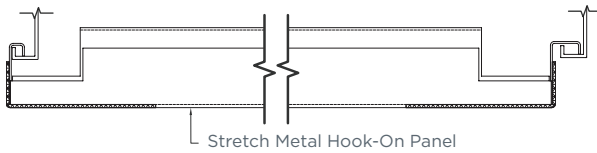

**Flat** (where the welded stretch metal is flat and covers the stretch metal hook-on panel face.)

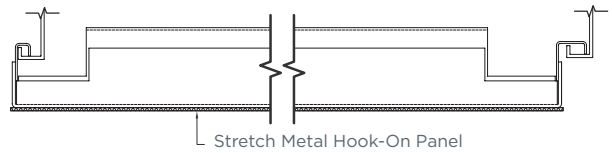

#### Panel Types

**Single** (stretch metal panel for designs that only require one panel width.)

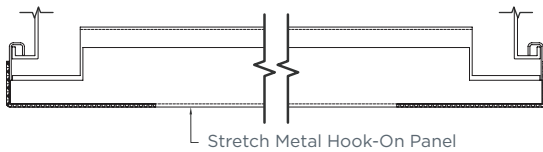

**Continuous** (stretch metal panel for continuous configurations.)

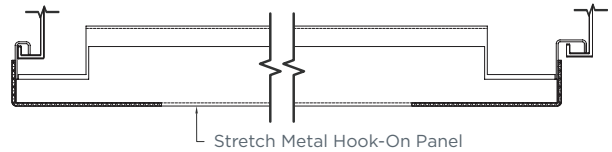

Additional options available for design flexibility, contact your local sales representative to get started.





Gdansk Lech Walesa Airport - New Terminal

## PHYSICAL DATA

### MATERIAL

Aluminum and Steel

### WEIGHT

Varies

### FIRE RATING

Class A Fire Rated per CAN/ULC-S102

- Painted or anodized metal: Flame spread  $\leq$  25,  
Smoke  $\leq$  50

### SEISMIC RATING

Classes A,B,C,D,E,F

### WIND LOAD

N/A

### RECYCLED CONTENT

Up to 92% (Aluminum)  
25% (Steel)

### LIGHT REFLECTANCE (LR) COEFFICIENT

PER ASTM E1264 & ASTM E1477

- Varies with finish

### WARRANTY

1-year Limited Warranty.

Full warranty information can be found  
at [certainteed.com/warranty](https://certainteed.com/warranty)



## CertainTeed ARCHITECTURAL PRODUCTS

METAL • WOOD • FELT • FIBERGLASS & MINERAL FIBER • GYPSUM • SUSPENSION & INTEGRATED SYSTEMS  
2424 Lakeshore Rd. West, Mississauga, ON L5J 1K4 800-233-8990 [certainteed.ca/architectural](https://certainteed.ca/architectural)