



Corporate Office, Pearl River NY

The Box Series linear metal ceiling system uses a universal carrier for simple design and installation.

FEATURES AND BENEFITS

- Panel Sizes:
 - Panel module widths: 2", 4", 6" and 8"
 - Panel lengths: 3' to 16'
 - Panel depths (nominal): 5/8" (Box 2, 4, 6 & 8)
- Square-edge design
- Curved carrier application available
- Waste reduction with factory fabricated dimensional material
- Downweight: reduce dead load with lightweight aluminum
- Easy plenum access, typically using access doors
- Interior and exterior applications
- Compatible with industry standard lighting, HVAC, speaker, fire safety, and security services

ATTRIBUTES



**FIRE RATING:
CLASS A
PER ASTM E84
AND CAN/ULC-S102**



**SEISMIC RATING:
ZONES A, B, C, D, E, F**



**CUSTOMIZATION
AVAILABLE**

LEED® v4

RECYCLED CONTENT

up to 92%

- ✓ EA: Optimize Energy Performance
- ✓ MR: Building Product Disclosure
- ✓ EQ: Low-Emitting Materials
- ✓ EQ: Indoor Air Quality Assessment
- ✓ EQ: Daylight
- ✓ EQ: Acoustic Performance

LEED® is a registered trademark of the U.S. Green Building Council.

CERTIFICATIONS



**GREENGUARD:
GOLD CERTIFIED**



EPD AVAILABLE

COLORS AND FINISHES

A wide choice of colors and finishes as well as custom color matching are available upon request. See website for the most up to date information and to order samples. Colors are for illustration purposes only.

STANDARD PAINT COLORS

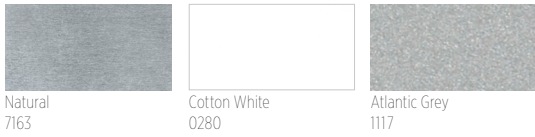

CUSTOM COLORS



STANDARD METALLIC



WHITE FINISH OPTIONS

Powder-coat paint finish for Arctic White #1015P (Gloss 10-20); Crystalline White #1050P (Gloss 45-55); Supernova White #1085P (Gloss 80-90). Aviation White #1011P: Powder-coat paint finish offering - LRV 90 - 9% gloss finish.

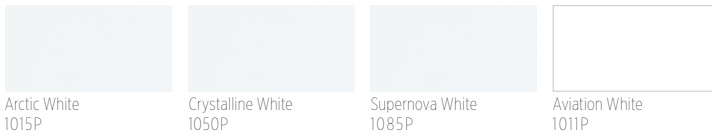

BLACK FINISH OPTIONS

Powder-coat paint finish for Starless Black #5000P (Matte); Raven Black #5030P (Gloss 25-35); Sable Black #5060P (Gloss 65-75); Wet Glass Black #5095P (Gloss 90-95)



ANODIZED FINISH OPTIONS

Anodized aluminum class II finish for Aged Bronze #10008 (Matte); Britannia Pewter #1009



STANDARD WOOD VENEER OPTIONS

Real wood veneer (on interior, non-perforated panels only). Formaldehyde-free, Class A composite panel. Note: This is a small subset of veneers available. Please contact manufacturer for client-specific species and stains.

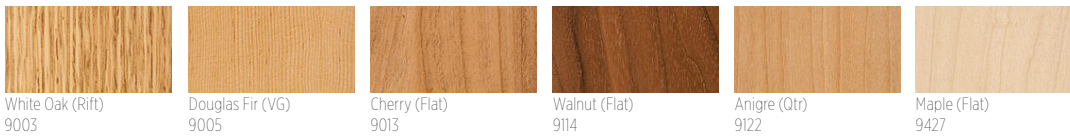

DECORATED (POWDER-COAT) WOOD-LOOK OPTIONS

Powder-coat paint finish (interior and exterior). Formaldehyde-free, Class A composite panel. This finish is recommended for exterior conditions.



Additional finishes available upon request. Please contact your local sales representative for more information.

LAMINATED (FILM) WOOD FINISHES

Film (on interior, non-perforated panels only). Formaldehyde-free, Class A composite panel. Minimums apply.

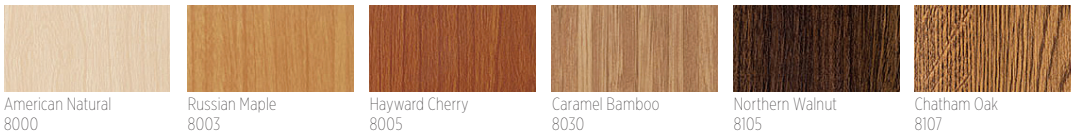

PERFORATION PATTERNS

Standard patterns shown. Perforations not available on real wood veneer or laminated (film). Scale shown: 1:1, unless otherwise noted.

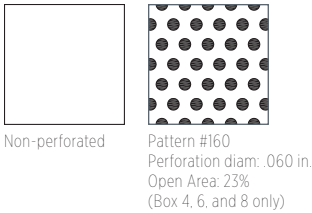

INSTALLATION EXAMPLES

Typical Isometrics

Box 8 shown for illustrative purposes only. See website for all sizes.

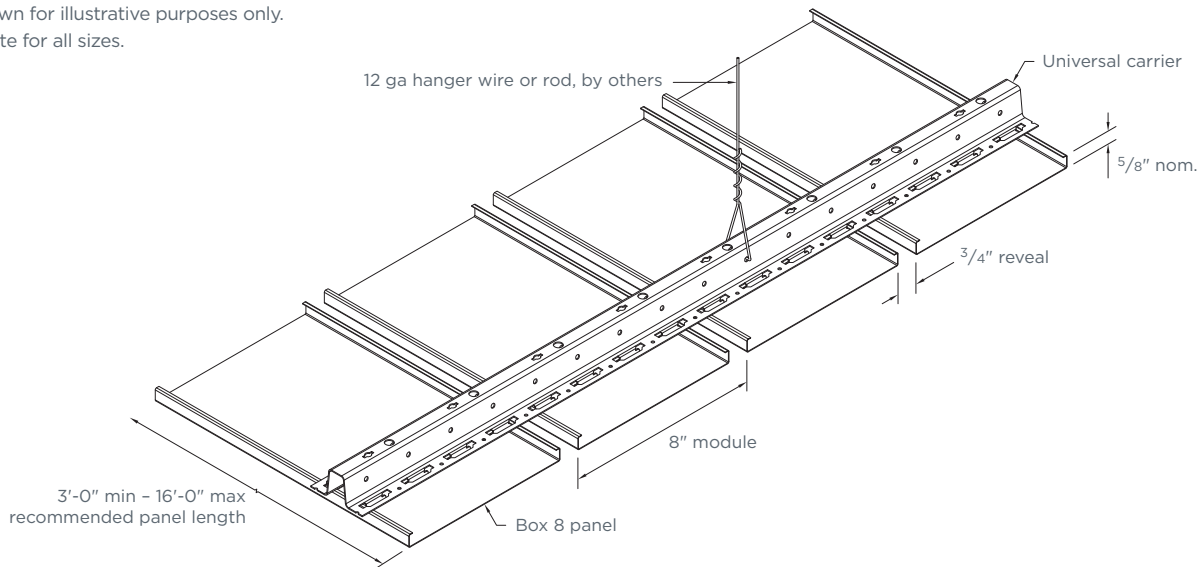

Typical Sections

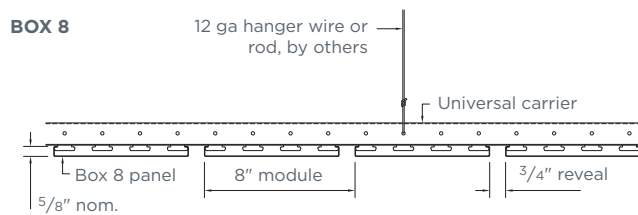

Additional options available for design flexibility, contact your local sales representative to get started.

PHYSICAL DATA

MATERIAL

Aluminum

WEIGHT

Varies 1.0 - 1.6 lbs./sq.ft.

FIRE RATING

Class A Fire Rated per ASTM E84

- Painted or anodized metal: Flame spread: ≤ 25 , Smoke ≤ 50
- Film on metal: Flame spread: ≤ 25 , Smoke ≤ 50 (for interior applications)
- Wood veneer on metal: Flame spread: ≤ 25 , Smoke ≤ 55 (for interior applications)

Class A Fire Rated per CAN/ULC-S102

- Painted or anodized metal: Flame spread: ≤ 25 , Smoke ≤ 50

SEISMIC RATING

Zones A,B,C,D,E,F

WIND LOAD

Per code. (for exterior applications)

RECYCLED CONTENT

Up to 92%

LIGHT REFLECTANCE (LR) COEFFICIENT PER ASTM E1264 & ASTM E1477

- Varies with finish
- Cotton White: LR = 0.81

WARRANTY

1-year Limited Warranty.

Full warranty information can be found at certainteed.com/warranty

ACOUSTICAL PERFORMANCE

Sound absorption can be achieved by the addition of backing ceiling panels with acoustical fabric or pad.

PRODUCT	ACOUSTICAL INFILL	NRC
Box 2, non-perforated, open reveal	1.5" - 1.5 pcf Polywrapped Fiberglass	0.90
Box 4, non-perforated, open reveal	1.5" - 1.5 pcf Polywrapped Fiberglass	0.75
Box 4, Perforated #160 (23% open area), open reveal	1.5" - 1.5 pcf Polywrapped Fiberglass	0.90
Box 4, Perforated #160 (23% open area), with Box Flat Closure Strip	Nonwoven	0.70
Box 4, Perforated #160 (23% open area), with Box Flat Closure Strip	1.5" - 1.5 pcf Polywrapped Fiberglass	0.85
Box 6, non-perforated, open reveal	1.5" - 1.5 pcf Polywrapped Fiberglass	0.65
Box 6, Perforated #160 (23% open area), open reveal	1.5" - 1.5 pcf Polywrapped Fiberglass	0.90
Box 6, Perforated #160 (23% open area), with Box Flat Closure Strip	Nonwoven	0.70
Box 6, Perforated #160 (23% open area), with Box Flat Closure Strip	1.5" - 1.5 pcf Polywrapped Fiberglass	0.80
Box 8, non-perforated, open reveal	1.5" - 1.5 pcf Polywrapped Fiberglass	0.50
Box 8, Perforated #160 (23% open area), open reveal	1.5" - 1.5 pcf Polywrapped Fiberglass	0.90
Box 8, Perforated #160 (23% open area), with Box Flat Closure Strip	Nonwoven	0.70
Box 8, Perforated #160 (23% open area), with Box Flat Closure Strip	1.5" - 1.5 pcf Polywrapped Fiberglass	0.85

* Acoustical tests performed in accordance with ASTM C423 and ASTM E795, in a type E400 mounting. Test reports available upon request.



CertainTeed ARCHITECTURAL

METAL • WOOD • FELT • FIBERGLASS & MINERAL FIBER • GYPSUM • SUSPENSION & INTEGRATED SYSTEMS
20 Moores Road, Malvern, PA 19355 800-366-4327 certainteed.com/architectural

