



HeartFelt® Nuvola™ brings the innovative and artistic cloud panels option to our portfolio of patented felt ceiling and wall systems. Turn any ceiling into a visual and acoustic playground with ease. Nuvola options are available with pre-established bill of materials and standard pricing. Quick shipment and easy install help you get beautiful results faster.

FEATURES AND BENEFITS

- Standard Panel Profile: HeartFelt Linear: 40HL55 - (40mm x 55mm) 1-9/16" x 2-3/16"
- x20 standard-shaped clouds (see next page for list of sizes available)
- Modular system with square profile design, offering easy plenum access and compatibility with industry standard lighting, HVAC, fire safety, and security components
- Available in standard 60mm carrier module
- Additional custom options available—may require longer lead time
- Red Dot Award 2017 Winner - Best of the Best

ALL PRODUCTS IN THIS LINE FEATURE THESE ATTRIBUTES



NRC
UP TO 0.60



CLASS A FIRE RATED
ASTM E84



SEISMIC RATING:
ZONE A, B, C, D, E, F



CUSTOMIZATION
AVAILABLE

LEED® v4

- ✓ MR: Building Product Disclosure
- ✓ EQ: Low-Emitting Materials
- ✓ EQ: Indoor Air Quality Assessment
- ✓ EQ: Acoustic Performance

LEED® is a registered trademark of the U.S. Green Building Council.

CERTIFICATIONS



GREENGUARD:
GOLD CERTIFIED



CRADLE-TO-CRADLE:
BRONZE CERTIFIED



MATERIAL HEALTH:
BRONZE CERTIFIED

HeartFelt® is a registered trademark of Hunter Douglas, Inc. used with permission.

FINISHING AND CUSTOMIZATION OPTIONS

Face of Panel

The standard HeartFelt Nuvola product offers an array of grey and earth tone colors in single-color kits.

COLORS

HeartFelt – Greys



HeartFelt – Earth Tones



STANDARD CONFIGURATION OPTIONS FOR HEARTFELT NUVOLA SYSTEMS

END CAP

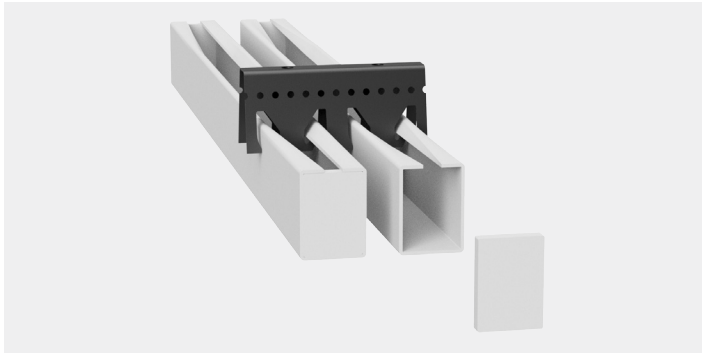

Standard 40HL55 profile and end cap included in kits.



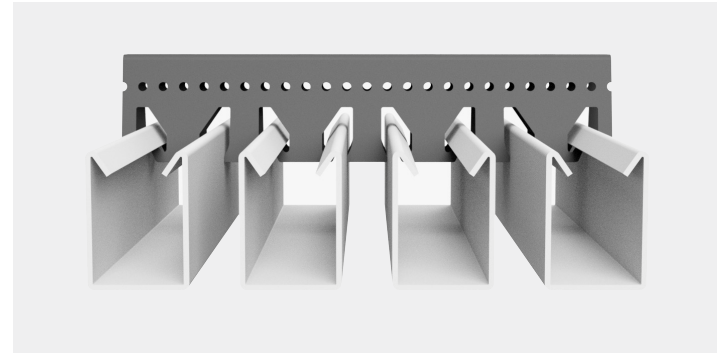

STANDARD CARRIER OPTIONS







60mm Spacing. Please contact us if a different carrier spacing is requested.

AVAILABLE STANDARD SIZES

STANDARD ROUND NUVOLA:







Description:	Item #:
2' Round 	HFK2RM60HL55
4' Round 	HFK4RM60HL55
6' Round 	HFK6RM60HL55
8' Round 	HFK8RM60HL55

STANDARD SQUARE NUVOLA:

Description:	Item #:
2' W x 2' L 	HFK22RM60HL55
4' W x 4' L 	HFK44RM60HL55
6' W x 6' L 	HFK66RM60HL55
8' W x 8' L 	HFK88RM60HL55

STANDARD RECTANGULAR NUVOLA:

Description:	Item #:
2' W x 4' L 	HFK24RM60HL55
2' W x 6' L 	HFK26RM60HL55
2' W x 8' L 	HFK28RM60HL55
4' W x 2' L 	HFK42RM60HL55
4' W x 6' L 	HFK46RM60HL55
4' W x 8' L 	HFK48RM60HL55

Description:	Item #:
6' W x 2' L 	HFK62RM60HL55
6' W x 4' L 	HFK64RM60HL55
6' W x 8' L 	HFK68RM60HL55
8' W x 2' L 	HFK82RM60HL55
8' W x 4' L 	HFK84RM60HL55
8' W x 6' L 	HFK86RM60HL55

INSTALLATION EXAMPLES

Typical Isometrics

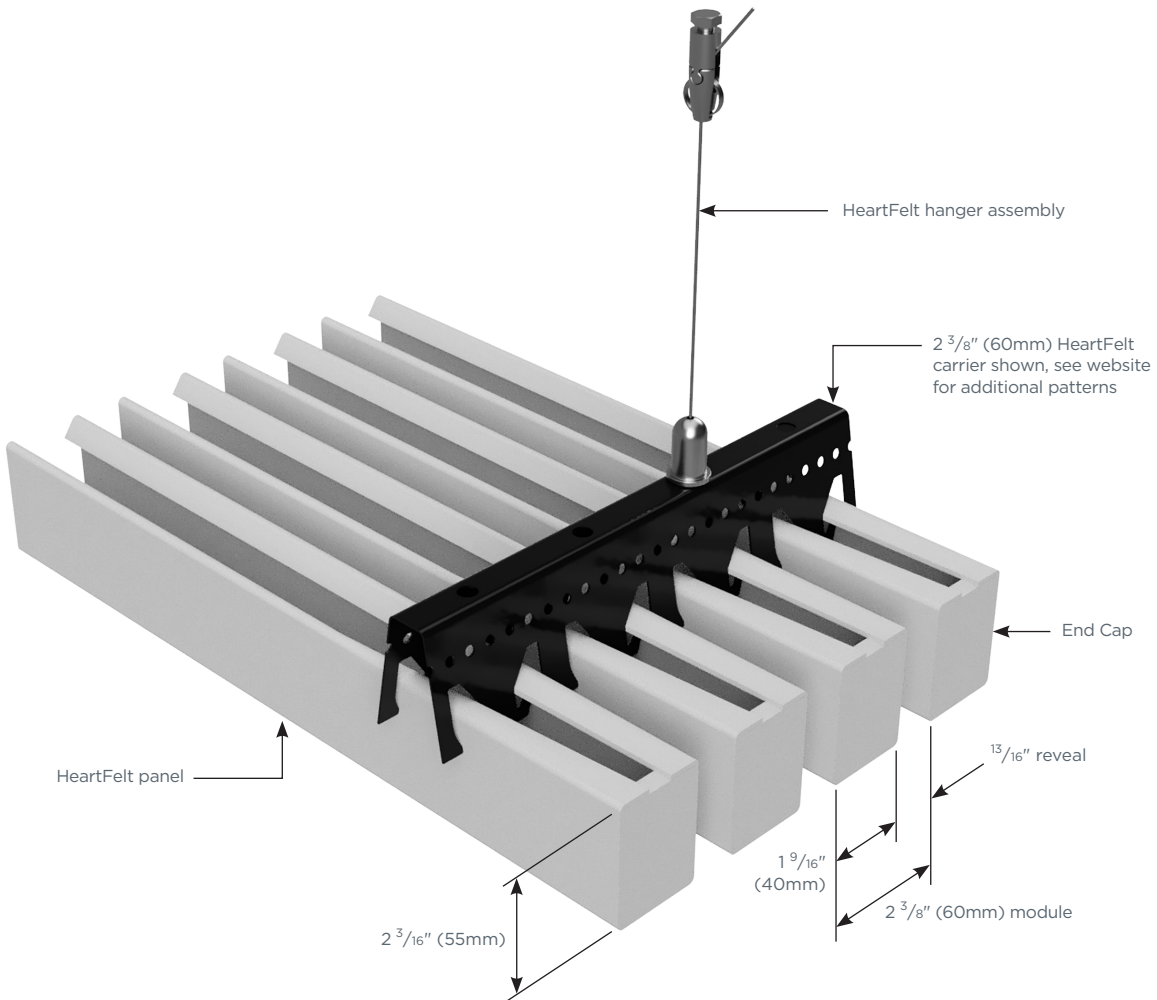
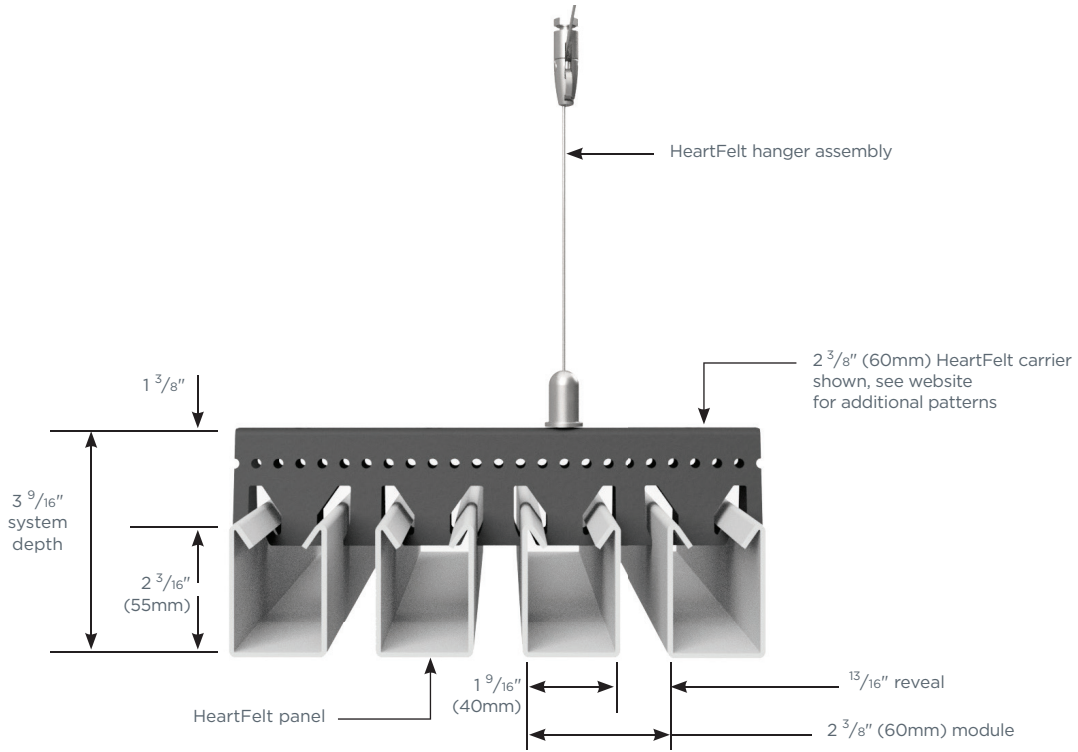



PHYSICAL DATA

MATERIAL

Non-woven PES fibers (felt)

WEIGHT

Varies

FIRE RATING

Class A Fire Rated per ASTM E84
Canada - per CAN/ULC S102.2-10

SEISMIC RATING

ZONES A,B,C,D,E,F

VISUAL CONSIDERATIONS

Given the unique and special nature of our HeartFelt® ceiling product, steps should be taken (before and during installation, as well as over the lifetime of the ceiling) to avoid or minimize static and the accumulation of dust, lint, dirt or airborne particles on or around the felt. Manufacturer does not warrant against or take responsibility for any such static or accumulation.

LIGHT REFLECTANCE

Varies with color

WARRANTY

1-year Limited Warranty.
Full warranty information can be found at [certainteed.com/warranty](https://www.certainteed.com/warranty)

ACCOUSTICAL PERFORMANCE

CARRIER SPACING	60mm
NRC	0.60

Results when tested with 40HL55 panels. Acoustical tests performed in accordance with ASTM C423 in a type E400 mounting. Test reports available upon request.



CertainTeed ARCHITECTURAL

METAL • WOOD • FELT • FIBERGLASS & MINERAL FIBER • GYPSUM • SUSPENSION & INTEGRATED SYSTEMS
20 Moores Road, Malvern, PA 19355 800-366-4327 [CertainTeed.com/Architectural](https://www.CertainTeed.com/Architectural)