

Bufftech[®]

Molded and Extruded Fence Products

2021 Product Catalog

CertainTeed
SAINT-GOBAIN

Post & Rail - Est. Cost per Lineal Foot Worksheet	Page 4
Residential - Est. Cost per Lineal Foot Worksheet	Pages 5-7
Privacy Molded (6 ft. & 8 ft. wide)	
Allegheny® (4 ft. high x 8 ft. wide).....	Page 8
Allegheny (6 ft. high x 6 ft. wide).....	Page 9
Allegheny (8 ft. high x 8 ft. wide).....	Page 10
Sherwood (4 ft. high x 8 ft. wide).....	Page 11
Sherwood (6 ft. high x 6 ft. wide).....	Page 12
Sherwood (8 ft. high x 8 ft. wide).....	Page 13
Fence Components and Accessories Molded	Pages 14-15
Privacy Extruded (6 ft. wide)	
Brookline Smooth (4 ft. high).....	Page 16
Brookline Smooth (5 ft. high).....	Page 17
Brookline Smooth (6 ft. high).....	Page 18
Brookline with CertaGrain Texture (4 ft. high).....	Page 19
Brookline with CertaGrain Texture (5 ft. high).....	Page 20
Brookline with CertaGrain Texture (6 ft. high).....	Page 21
Privacy Extruded (8 ft. wide)	
Chesterfield (4 ft. high).....	Page 22
Chesterfield with Lattice Accent (5 ft. high).....	Page 23
Chesterfield (5 ft. high).....	Page 24
Chesterfield (6 ft. high).....	Page 25
Chesterfield S Curve (6 ft. high).....	Page 26
Chesterfield Swoop (6 ft. high).....	Page 27
Chesterfield Decorative Gates.....	Page 28
Chesterfield with Lattice Accent (6 ft. high).....	Page 29
Chesterfield with Huntington Accent (6 ft. high).....	Page 30
Chesterfield with Victorian Accent (6 ft. high).....	Page 31
Chesterfield with Westminster Accent (6 ft. high).....	Page 32
Chesterfield with CertaGrain Texture (4 ft. high).....	Page 33
Chesterfield with CertaGrain Texture (5 ft. high).....	Page 34
Chesterfield with CertaGrain Texture (6 ft. high).....	Page 35
Chesterfield with CertaGrain Texture Concave.....	Page 36
Chesterfield with CertaGrain Texture Convex (5-1/2-6 ft. high).....	Page 37
Chesterfield with CertaGrain Texture Convex (6-6-1/2 ft. high).....	Page 38
Chesterfield with CertaGrain Texture S-Curve.....	Page 39
Chesterfield with CertaGrain Texture Swoop.....	Page 40
Chesterfield with CertaGrain Texture Gates.....	Page 41
Chesterfield with CertaGrain Texture and Spindle Accent (6 ft. high).....	Page 42
Chesterfield with CertaGrain Texture with Victorian Accent (6 ft. high).....	Page 43
Galveston (7 ft. high).....	Page 44
Galveston (8 ft. high).....	Page 45
Galveston with Lattice Accent (8 ft. high).....	Page 46
Galveston with Victorian Accent (8 ft. high).....	Page 47
Galveston with CertaGrain Texture (7 ft. high).....	Page 48
Galveston with CertaGrain Texture (8 ft. high).....	Page 49
New Lexington (48" high).....	Page 50
New Lexington (60" high).....	Page 51
New Lexington (72" high).....	Page 52
New Lexington S Curve (72" high).....	Page 53
New Lexington Swoop (72"high).....	Page 54
New Lexington with Lattice Accent (72" high).....	Page 55
New Lexington with Victorian Accent (72" high).....	Page 56
Semi-Private Extruded (8 ft. wide)	
Breezewood with Select Cedar Texture (4 ft. high).....	Page 57
Breezewood with Select Cedar Texture (5 ft. high).....	Page 58
Breezewood with Select Cedar Texture (6 ft. high).....	Page 59
Columbia (6 ft. high).....	Page 60
Imperial (4 ft. high).....	Page 61
Imperial (5 ft. high).....	Page 62
Imperial (6 ft. high).....	Page 63
Imperial with Select Cedar Texture (4 ft. high).....	Page 64
Imperial with Select Cedar Texture (5 ft. high).....	Page 65
Imperial with Select Cedar Texture (6 ft. high).....	Page 66
Millbrook (5 ft. high).....	Page 67
Millbrook (6 ft. high).....	Page 68
Contemporary Extruded (8 ft. wide)	
Baron (4 ft. high).....	Page 69
Baron (5 ft. high).....	Page 70
Baron (6 ft. high).....	Page 71
Baron with Select Cedar Texture (4 ft. high).....	Page 72
Baron with Select Cedar Texture (5 ft. high).....	Page 73
Baron with Select Cedar Texture (6 ft. high).....	Page 74
Countess (4 ft. high).....	Page 75
Countess (5 ft. high).....	Page 76
Countess (6 ft. high).....	Page 77
Princeton (4 ft. high).....	Page 78
Princeton (5 ft. high).....	Page 79
Princeton (6 ft. high).....	Page 80
Victorian (4 ft. high).....	Page 81
Victorian (5 ft. high).....	Page 82
Victorian (6 ft. high).....	Page 83
Classic Extruded (8 ft. wide)	
Manchester (3 ft. high).....	Page 84
Manchester (4 ft. high).....	Page 85
Manchester Concave (3 ft. high).....	Page 86
Manchester Concave (4 ft. high).....	Page 87
Traditional Extruded	
12 Picket (6 ft. wide)	
Cape Cod (3 ft. high).....	Page 88
Cape Cod (4 ft. high).....	Page 89
Cape Cod Concave (3 ft. high).....	Page 90
Cape Cod Concave (4 ft. high).....	Page 91
15 Picket (8 ft. wide)	
Danbury (4 ft. high).....	Page 92
Danbury Concave (4 ft. high).....	Page 93
Danbury with Select Cedar Texture (4 ft. high).....	Page 94
Danbury Concave with Select Cedar Texture (4 ft. high).....	Page 95
Rothbury (4 ft. high).....	Page 96
Rothbury Concave (4 ft. high).....	Page 97
Gate Applications Extruded	Page 98
Post & Rail Extruded	
2 Rail Fence.....	Page 99
3 Rail Fence.....	Page 100
4 Rail Fence.....	Page 101
Crossbuck.....	Page 102
2 Rail Fence with CertaGrain Texture.....	Page 103
3 Rail Fence with CertaGrain Texture.....	Page 104
4 Rail Fence with CertaGrain Texture.....	Page 105
2 Rail Fence with CertaGrain Texture White.....	Page 106
3 Rail Fence with CertaGrain Texture White.....	Page 107
4 Rail Fence with CertaGrain Texture White.....	Page 108
Post & Rail Truckload Calculations.....	Page 109
Fence Components and Accessories Extruded	Pages 110-112
Mounting Brackets.....	Page 113
Bulk Components - Pallet Quantities Extruded	Pages 114
Post Routing Template Kits	Pages 115-116
Railing (6, 8 and 10 ft. wide)	
Before You Begin.....	Page 117
Kingston Flat (3 ft. high).....	Page 118
Kingston Stair/Step (3 ft. high).....	Page 119
Kingston Flat (3.5 ft. high).....	Page 120
Kingston Stair/Step (3.5 ft. high).....	Page 121
Oxford Flat (3 ft. high).....	Page 122
Oxford Stair/Step (3 ft. high).....	Page 123
Oxford Flat (3.5 ft. high).....	Page 124
Oxford Stair/Step (3.5 ft. high).....	Page 125
Porch Posts/Columns	Page 126
Handrail	Page 127
Deck	Page 128
Bufftech Order Form	Page 129
Request for Material Estimate	Page 130
Request for Deck Estimate	Page 131

Estimated Material Cost Per Lineal Foot Worksheet

You Should Know

This is a guideline only. It should be used as a reference and as an aid in selling Bufftech fence.

Formula

- For Residential fence styles, select post installation method.
Estimate lineal footage cost of that installation method = A.
- A x total length of fence needed (include gate area if using kit).
Round lineal footage up to the nearest full section based upon either 6' or 8' centers (center depends on style of fence) = B.
Example: 100' (13 full sections plus 2' 6" remains) on 8' center is rounded to 105' (14 full sections).
- B + cost of gate(s) = C.
- C = Estimated cost of material.
Be sure to add an ending post and any gate posts required.

Post & Rail Fence Estimated Price Per Foot

The following is a guide for approximate MATERIAL COST per lineal foot of Bufftech Fence.

(Based on rails, 5 in. x 5 in. posts, internal post caps and lock rings needed to build fence on 8 ft. centers — 6 ft. centers for blend colors — you will need to add an ending post and any gates required.)

	2 Rail (68 in. Post)	3 Rail (84 in. Post)	4 Rail (96 in. Post)
Top Rail Height:	36"	54"	60"
1-1/2" x 5-1/2" Ribbed Rails	\$_____ per ft.	\$_____ per ft.	\$_____ per ft.
2" x 6" Ribbed Rails	-	\$_____ per ft.	\$_____ per ft.
2" x 6" with CertaGrain Texture (Arctic Blend, Brazilian Blend, Sierra Blend, Weathered Blend)	\$_____ per ft.	\$_____ per ft.	\$_____ per ft.
1-1/2" x 5-1/2" with CertaGrain Texture	\$_____ per ft.	\$_____ per ft.	\$_____ per ft.

Crossbuck (84 in. Post)

Top Rail Height:	54"
1-1/2" x 5-1/2" Ribbed Top & Bottom Rails	
1-1/2" x 5-1/2" Ribbed Cross Rails	\$_____ per ft.

Gate Kits (Large or Small Rail):	<u>2 Rail</u>	<u>3 Rail</u>	<u>4 Rail</u>
8 ft. Width	\$_____	\$_____	\$_____
Small Rail with CertaGrain Texture	\$_____	\$_____	\$_____
Large Rail with CertaGrain Texture	\$_____	\$_____	\$_____

Crossbuck

8 ft. Width	\$_____
-------------	---------

Look for these icons throughout the brochure on products that meet special performance requirements.



WINDZONE™ PERFORMANCE

Miami-Dade County-approved NOA for exceptional performance in high wind conditions. To comply with Windzone Performance, additional items are needed for installation.

NOA # 20-0303.02 expires 03/13/2024

NOA # 20-0303.01 expires 04/04/2023 (molded)



MEETS POOL CODE

Styles that meet most local building codes for use around pools (applies to 4', 5' and 6' heights only). Check with your local building code official as local codes may vary.

Residential Fence Estimated Price Per Foot Worksheet

THE FOLLOWING IS A GUIDE FOR APPROXIMATE MATERIAL COST PER LINEAL FOOT OF BUFFTECH FENCE. ESTIMATED PRICE PER FOOT - BASED ON (1) IN-GROUND POST, (1) UNASSEMBLED FENCE SECTION, (1) FLAT CAP (GOTHIC CAP USED WHERE NOTED). DIVIDED BY 8 FOR 8' CENTER SECTIONS & DIVIDED BY 6 FOR 6' CENTER SECTIONS.

RESIDENTIAL FENCE STYLE	FENCE HEIGHT					
	3'	4'	5'	6'	7'	8'
PRIVACY (6' CENTERS)						
ALLEGHENY* (BEIGE GRANITE, BLACK GRANITE, BROWN GRANITE, DARK BROWN GRANITE, GRAY GRANITE)	-	-	-	\$ _____	-	-
SHERWOOD (BLACK OAK, GOLD CEDAR, NANTUCKET GRAY, RED CEDAR, WALNUT BROWN)	-	-	-	\$ _____	-	-
BROOKLINE (ALMOND, CLAY, WHITE)	-	\$ _____	\$ _____	\$ _____	-	-
BROOKLINE WITH CERTAGRAIN TEXTURE (ARCTIC BLEND, BRAZILIAN BLEND, SIERRA BLEND, WEATHERED BLEND)	-	\$ _____	\$ _____	\$ _____	-	-
PRIVACY (8' CENTERS)						
ALLEGHENY (BEIGE GRANITE, BLACK GRANITE, BROWN GRANITE, DARK BROWN GRANITE, GRAY GRANITE)	-	\$ _____	-	-	-	\$ _____
SHERWOOD (BLACK OAK, GOLD CEDAR, NANTUCKET GRAY, RED CEDAR, WALNUT BROWN)	-	\$ _____	-	-	-	\$ _____
CHESTERFIELD (ALMOND, CLAY, GREY, WHITE - 4' WHITE AND ALMOND ONLY, GREY 6' ONLY)	-	\$ _____	\$ _____	\$ _____	-	-
CHESTERFIELD WITH LATTICE ACCENT (ALMOND, WHITE)	-	-	\$ _____	\$ _____	-	-
CHESTERFIELD WITH HUNTINGTON ACCENT (ALMOND, WHITE)	-	-	-	\$ _____	-	-
CHESTERFIELD WITH VICTORIAN ACCENT (ALMOND, WHITE)	-	-	-	\$ _____	-	-
CHESTERFIELD WITH WESTMINSTER ACCENT (WHITE)	-	-	-	\$ _____	-	-
CHESTERFIELD WITH CERTAGRAIN TEXTURE (ALMOND, ARBOR BLEND, ARCTIC BLEND, BRAZILIAN BLEND, CLAY, FRONTIER BLEND, SIERRA BLEND, TIMBER BLEND, WEATHERED BLEND, WHITE)	-	\$ _____	\$ _____	\$ _____	-	-
CHESTERFIELD WITH CERTAGRAIN TEXTURE - CONCAVE (ARCTIC BLEND, BRAZILIAN BLEND, SIERRA BLEND, WEATHERED BLEND)	-	-	-	\$ _____	-	-
CHESTERFIELD WITH CERTAGRAIN TEXTURE - CONVEX (ARCTIC BLEND, BRAZILIAN BLEND, SIERRA BLEND, WEATHERED BLEND)	-	-	-	\$ _____	-	-
CHESTERFIELD WITH CERTAGRAIN TEXTURE VICTORIAN ACCENT (ALMOND, ARCTIC BLEND, BRAZILIAN BLEND, CLAY, SIERRA BLEND, WEATHERED BLEND, WHITE)	-	-	-	\$ _____	-	-
CHESTERFIELD WITH CERTAGRAIN TEXTURE AND SPINDLE ACCENT (ARCTIC BLEND, BRAZILIAN BLEND, CLAY, SIERRA BLEND, WEATHERED BLEND, WHITE)	-	-	-	\$ _____	-	-
GALVESTON (ALMOND, WHITE)	-	-	-	-	\$ _____	\$ _____
GALVESTON WITH LATTICE ACCENT (ALMOND, WHITE)	-	-	-	-	-	\$ _____

Residential Fence Estimated Price Per Foot Worksheet

THE FOLLOWING IS A GUIDE FOR APPROXIMATE MATERIAL COST PER LINEAL FOOT OF BUFFTECH FENCE. ESTIMATED PRICE PER FOOT - **BASED ON (1) IN-GROUND POST, (1) UNASSEMBLED FENCE SECTION, (1) FLAT CAP (GOTHIC CAP USED WHERE NOTED)**. DIVIDED BY 8 FOR 8' CENTER SECTIONS & DIVIDED BY 6 FOR 6' CENTER SECTIONS.

RESIDENTIAL FENCE STYLE	FENCE HEIGHT					
	3'	4'	5'	6'	7'	8'
PRIVACY (8' CENTERS)						
GALVESTON WITH VICTORIAN ACCENT (ALMOND, WHITE)	-	-	-	-	-	\$ _____
GALVESTON WITH CERTAGRAIN TEXTURE (ARBOR BLEND, ARCTIC BLEND, BRAZILIAN BLEND, CLAY, FRONTIER BLEND, SIERRA BLEND, WEATHERED BLEND)	-	-	-	-	\$ _____	\$ _____
NEW LEXINGTON (ALMOND, WHITE)	-	\$ _____	\$ _____	\$ _____	-	-
NEW LEXINGTON WITH LATTICE ACCENT (ALMOND, WHITE)	-	-	-	\$ _____	-	-
NEW LEXINGTON WITH VICTORIAN ACCENT (ALMOND, WHITE)	-	-	-	\$ _____	-	-
SEMI-PRIVACY (8' CENTERS)						
BREEZEWOOD WITH SELECT CEDAR TEXTURE (ALMOND, ARCTIC BLEND, BRAZILIAN BLEND, CLAY, SIERRA BLEND, WEATHERED BLEND, WHITE)	-	\$ _____	\$ _____	\$ _____	-	-
COLUMBIA (WHITE)	-	-	-	\$ _____	-	-
IMPERIAL (ALMOND, CLAY, WHITE)	-	\$ _____	\$ _____	\$ _____	-	-
IMPERIAL WITH SELECT CEDAR TEXTURE (ALMOND, ARBOR BLEND, ARCTIC BLEND, BRAZILIAN BLEND, CLAY, FRONTIER BLEND, SIERRA BLEND, TIMBER BLEND, WEATHERED BLEND, WHITE)	-	\$ _____	\$ _____	\$ _____	-	-
MILLBROOK (WHITE)	-	-	\$ _____	\$ _____	-	-
CONTEMPORARY (8' CENTERS)						
BARON (ALMOND, CLAY, WHITE)	-	\$ _____	\$ _____	\$ _____	-	-
BARON WITH SELECT CEDAR TEXTURE (ALMOND, ARBOR BLEND, ARCTIC BLEND, BRAZILIAN BLEND, CLAY, FRONTIER BLEND, SIERRA BLEND, TIMBER BLEND, WEATHERED BLEND, WHITE)	-	\$ _____	\$ _____	\$ _____	-	-
COUNTESS (ALMOND, WHITE)	-	\$ _____	\$ _____	\$ _____	-	-
PRINCETON (ALMOND, WHITE)	-	\$ _____	\$ _____	\$ _____	-	-
VICTORIAN (ALMOND, WHITE)	-	\$ _____	\$ _____	\$ _____	-	-

Residential Fence Estimated Price Per Foot Worksheet

THE FOLLOWING IS A GUIDE FOR APPROXIMATE MATERIAL COST PER LINEAL FOOT OF BUFFTECH FENCE. ESTIMATED PRICE PER FOOT - BASED ON (1) IN-GROUND POST, (1) UNASSEMBLED FENCE SECTION, (1) FLAT CAP (GOTHIC CAP USED WHERE NOTED). DIVIDED BY 8 FOR 8' CENTER SECTIONS & DIVIDED BY 6 FOR 6' CENTER SECTIONS.

RESIDENTIAL FENCE STYLE	FENCE HEIGHT				
	3'	4'	5'	6'	7'
CLASSIC (8' CENTERS)					
MANCHESTER (ALMOND, WHITE)	\$ _____	\$ _____	—	—	—
MANCHESTER CONCAVE (ALMOND, WHITE)	\$ _____	\$ _____	—	—	—
TRADITIONAL (6' CENTERS)					
12 PICKET CAPE COD (WHITE)	\$ _____	\$ _____	—	—	—
12 PICKET CAPE COD CONCAVE (WHITE)	\$ _____	\$ _____	—	—	—
TRADITIONAL (8' CENTERS)					
15 PICKET DANBURY, ROTHBURY (8' CENTER) (ALMOND, CLAY*, WHITE)	—	\$ _____	—	—	—
15 PICKET CONCAVE DANBURY, ROTHBURY (ALMOND, CLAY*, WHITE)	—	\$ _____	—	—	—
15 PICKET DANBURY WITH SELECT CEDAR TEXTURE (ALMOND, ARBOR BLEND, ARCTIC BLEND, CLAY, SIERRA BLEND, WEATHERED BLEND, WHITE)	—	\$ _____	—	—	—
15 PICKET CONCAVE DANBURY WITH SELECT CEDAR TEXTURE (ALMOND, ARBOR BLEND, ARCTIC BLEND, CLAY, SIERRA BLEND, WEATHERED BLEND, WHITE)	—	\$ _____	—	—	—

* Rothbury not available in Clay

PORCH RAILING SYSTEM (PRICE PER FOOT USING BLANK POST & RAIL MOUNT BRACKET KIT)

STYLE	RAILING HEIGHT: PICKET STYLE:	3'	3-1/2'	3'	3'	3'	3-1/2'
		ALUM.	ALUM.	1-1/2" SQ.	1-1/2" SQ.	BALUSTER	1-1/2" SQ.
KINGSTON (ALMOND, CLAY, WHITE)							
6' CENTERS		\$ _____	\$ _____	\$ _____	\$ _____	\$ _____	—
8' CENTERS		\$ _____	\$ _____	\$ _____	\$ _____	\$ _____	—
10' CENTERS				\$ _____	\$ _____	—	—

RAILING SYSTEM (PRICE PER FOOT USING ABOVE-GROUND POSTS & POST MOUNTING KITS)

STYLE	RAILING HEIGHT: PICKET STYLE:	3'	3-1/2'	3'	3'	3-1/2'	3-1/2'	CLEAR
		ALUM.	ALUM.	1-1/4" SQ.	BALUSTER	1-1/4" SQ.	BALUSTER	GLASS
OXFORD (ALMOND, CLAY, WHITE)								
6' CENTERS		\$ _____	\$ _____	\$ _____	\$ _____	\$ _____	\$ _____	\$ _____
8' CENTERS		\$ _____	\$ _____	\$ _____	\$ _____	\$ _____	\$ _____	—
10' CENTERS (WHITE ONLY)				\$ _____	—	\$ _____	—	—

**Privacy
Allegheny®**

4 ft. High / 8 ft. Wide

Select one of the available colors

- Beige Granite
- Black Granite / Black Oak
- Brown Granite
- Dark Brown Granite / Walnut Brown
- Gray Granite / Nantucket Gray

For colors, add color letters to item number: Beige Granite (BEG), Black Granite (BLK), Brown Granite (BRN), Dark Brown Granite (DBR), Gray Granite (GRY).

QUANTITY	PRODUCT NUMBER	DESCRIPTION
FENCE SECTIONS		
_____	ALG48X96	Allegheny Fence Panel 48 in. H x 96 in. W (For 96 in. Height order (2) 48 in. H Panel)
<i>Note: Fence section includes panel with steel reinforcement</i>		
5 IN. X 5 IN. POSTS		
_____	LP102	Line Post with Hardware 5 x 5 x 102 in.
_____	EP102	End Post with Hardware 5 x 5 x 102 in.
_____	CP102	Corner Post with Hardware 5 x 5 x 102 in.
<i>Note: Posts include panel support brackets and screws. (LP) = two brackets and two 1.5 in. screws. (CP) = two brackets, two 1.5 in. screws and four 3 in. screws. (EP) and (GP) = one bracket, one 1.25 in. screw and two 3 in. screws.</i>		
POST CAPS AND SKIRTS		
_____	PC5X5	Post Cap Square 5 in. x 5 in.
_____	PC5X10	Post Cap 45 Degree
_____	PC5X10G	Post Cap Double Inline
_____	SKIRTLP	Line Post Skirt
_____	SKIRTCP	Corner Post Skirt
_____	SKIRTEG	End Post / Gate Post Skirt
GATES (includes hinge and latch set)		
_____	ALGT48X48	Allegheny Gate 48 in. high x 48 in. wide with Hardware
_____	GP102	Gate Post with Hardware 5 x 5 x 102 in.
_____	DRG36	Drop Rod Gate Hardware
OPTIONAL/EXTRA MATERIAL		
_____	CPSB48X96	Cut Panel Support Bracket 4 ft. X 8 ft. Panels
_____	GF1X42	Gap Filler 1 in. Corner/Gate Post
_____	GF2X42	Gap Filler 2 in. Line/End Post
_____	FPB	Fence Panel Bracket-Zinc
_____	CMBLP6	Concrete Mounting Bracket 24 in. Line Post 6H 8x5 Base Plate
_____	CMBEP6	Concrete Mounting Bracket 24 in. End Post 6H 6.5x5 Base Plate
_____	CMBCP6	Concrete Mounting Bracket 24 in. Corner Post 6H 7x7 Base Plate
_____	CMBGP6	Concrete Mounting Bracket 24 in. Gate Post 6H 8x5 Base Plate
_____	801401	Self Close Hinge Set Black
_____	LATCH	Combo Latch / Striker Rod Set
_____	SCREW125	SCREW 1.25 in. (14X1.25)

A FENCE PANEL
 PALLET QUANTITY = 20
 48" x 96"
 Includes steel channel
 in top and bottom rail

B POST
 PALLET QUANTITY
 Line Post = 24
 End Post = 16
 Corner Post = 16
 5" x 5" x 102"
 SUPPLIED: 5" x 5" x 102"
 FIELD CUT: 5" x 5" x 78"

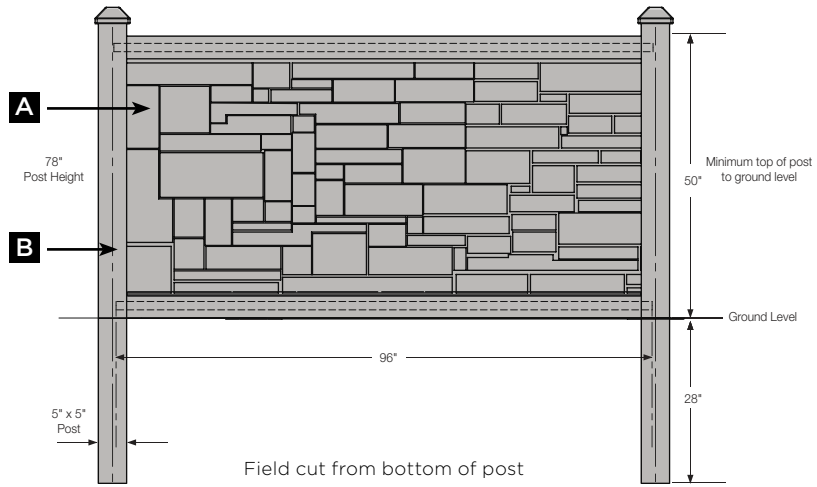
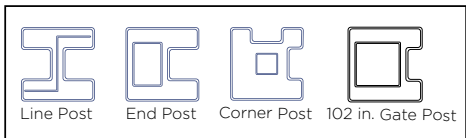

- Beige Granite
- Black Granite / Black Oak
- Brown Granite
- Dark Brown Granite / Walnut Brown
- Gray Granite / Nantucket Gray

For colors, add color letters to item number: Beige Granite (BEG), Black Granite (BLK), Brown Granite (BRN), Dark Brown Granite (DBR), Gray Granite (GRY).

QUANTITY	PRODUCT NUMBER	DESCRIPTION
----------	----------------	-------------

FENCE SECTIONS

_____	ALG72X72	Allegheny Fence Panel 72 in. H x 72 in. W
-------	----------	---

Note: Fence section includes panel with steel reinforcement

5 IN. X 5 IN. POSTS

_____	LP102	Line Post with Hardware 5 x 5 x 102 in.
_____	EP102	End Post with Hardware 5 x 5 x 102 in.
_____	CP102	Corner Post with Hardware 5 x 5 x 102 in.

Note: Posts include panel support brackets and screws. (LP) = two brackets and two 1.5 in. screws. (CP) = two brackets, two 1.5 in. screws and four 3 in. screws. (EP) and (GP) = one bracket, one 1.25 in. screw and two 3 in. screws.

POST CAPS AND SKIRTS

_____	PC5X5	Post Cap Square 5 in. x 5 in.
_____	PC5X10	Post Cap 45 Degree
_____	PC5X10G	Post Cap Double Inline
_____	SKIRTLP	Line Post Skirt
_____	SKIRTCP	Corner Post Skirt
_____	SKIRTEG	End Post / Gate Post Skirt

GATES (includes hinge and latch set)

_____	ALGT72X36	Allegheny Gate 70 in. high x 36 in. wide with Hardware
_____	ALGT72X48	Allegheny Gate 70 in. high x 48 in. wide with Hardware
_____	ALGT72X60	Allegheny Gate 70 in. high x 60 in. wide with Hardware
_____	ALGT72X72	Allegheny Gate 70 in. high x 71 in. wide with Hardware
_____	GP102	Gate Post with Hardware 5 x 5 x 102 in.
_____	DRG36	Drop Rod Gate Hardware

OPTIONAL/EXTRA MATERIAL

_____	GF1X42	Gap Filler 1 in. Corner/Gate Post
_____	GF2X42	Gap Filler 2 in. Line/End Post
_____	CPSB72X72	Cut Panel Support Bracket 6 ft. X 6 ft. Panels
_____	FPB	Fence Panel Bracket-Zinc
_____	CMBLP6	Concrete Mounting Bracket 24 in. Line Post 6H 8x5 Base Plate
_____	CMBEP6	Concrete Mounting Bracket 24 in. End Post 6H 6.5x5 Base Plate
_____	CMBCP6	Concrete Mounting Bracket 24 in. Corner Post 6H 7x7 Base Plate
_____	CMBGP6	Concrete Mounting Bracket 24 in. Gate Post 6H 8x5 Base Plate
_____	801401	Self Close Hinge Set Black
_____	LATCH	Combo Latch / Striker Rod Set
_____	SCREW125	SCREW 1.25 in. (14X1.25)

A FENCE PANEL
 PALLET QUANTITY = 22
 72" x 72"
 Includes steel channel in top and bottom rail

B POST
 PALLET QUANTITY
 Line Post = 24
 End Post = 16
 Corner Post = 16
 5" x 5" x 102"

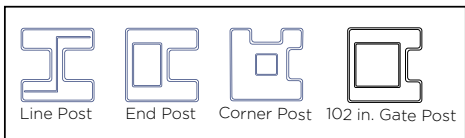

FEATURING WINDZONE TECHNOLOGY



MEETS POOL CODE

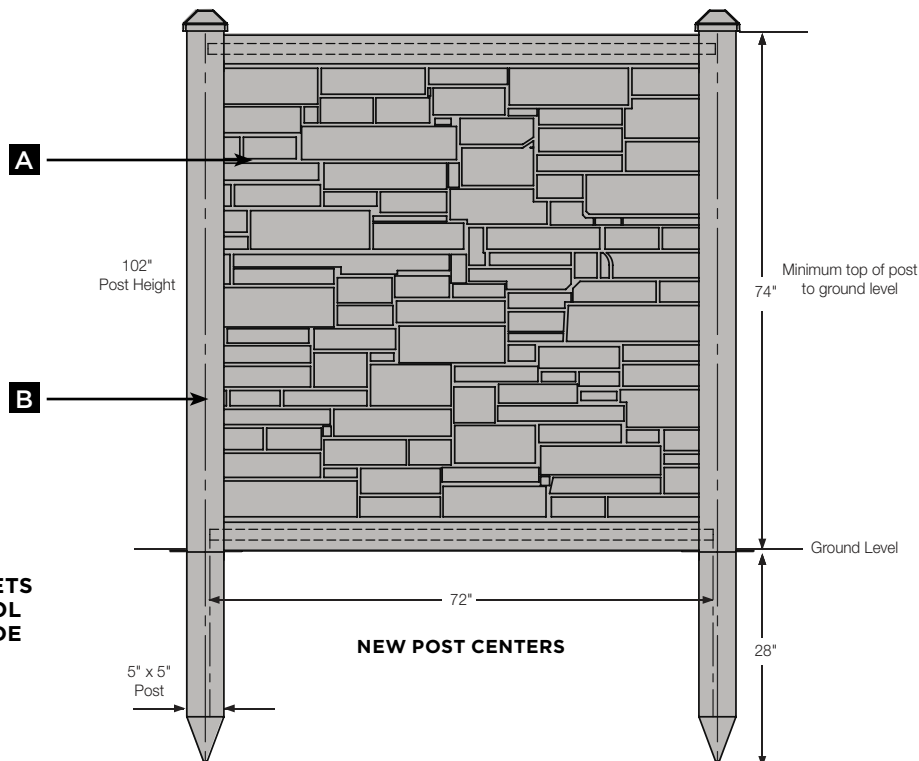

Privacy
Allegheny®

8 ft. High / 8 ft. Wide

- Select one of the available colors
- Beige Granite
 - Black Granite / Black Oak
 - Brown Granite
 - Dark Brown Granite / Walnut Brown
 - Gray Granite / Nantucket Gray

For colors, add color letters to item number: Beige Granite (BEG), Black Granite (BLK), Brown Granite (BRN), Dark Brown Granite (DBR), Gray Granite (GRY).

QUANTITY	PRODUCT NUMBER	DESCRIPTION
----------	----------------	-------------

FENCE SECTIONS

_____	ALG48X96	Allegheny Fence Panel 48 in. H x 96 in. W (For 96 in. Height order (2) 48 in. H Panel)
-------	----------	--

Note: Fence section includes panel with steel reinforcement

5 IN. X 5 IN. POSTS

_____	LP142	Line Post with Hardware 5 x 5 x 142 in.
_____	EP142	End Post with Hardware 5 x 5 x 142 in.

Note: Posts include panel support brackets and screws. (LP) = two brackets and two 1.5 in. screws. (EP) and (GP) = one bracket, one 1.25 in. screw and two 3 in. screws.

POST CAPS AND SKIRTS

_____	PC5X5	Post Cap Square 5 in. x 5 in.
_____	PC5X10	Post Cap 45 Degree
_____	PC5X10G	Post Cap Double Inline
_____	SKIRTLP	Line Post Skirt
_____	SKIRTEG	End Post / Gate Post Skirt

GATES (includes hinge and latch set)

_____	ALGT96X48	Allegheny Gate 96 in. high x 48 in. wide with Hardware
_____	GP142	Gate Post with Hardware 5 x 5 x 142 in.
_____	DRG36	Drop Rod Gate Hardware

OPTIONAL/EXTRA MATERIAL

_____	GF1X42	Gap Filler 1 in. Corner/Gate Post
_____	GF2X42	Gap Filler 2 in. Line/End Post
_____	CPSB48X96	Cut Panel Support Bracket 4 ft. X 8 ft. Panels
_____	FPB	Fence Panel Bracket-Zinc
_____	CMBLP8	Concrete Mounting Bracket 24 in. Line Post 8H 8x5 Base Plate
_____	CMBEP8	Concrete Mounting Bracket 24 in. End Post 8H 8x5 Base Plate
_____	801401	Self Close Hinge Set Black
_____	LATCH	Combo Latch / Striker Rod Set
_____	SCREW125	SCREW 1.25 in. (14X1.25)

A FENCE PANEL
PALLET QUANTITY = 20
2 - 48" x 96" panels
Includes steel channel
in top and bottom rail

B POST
PALLET QUANTITY = 27
5" x 5" x 142"

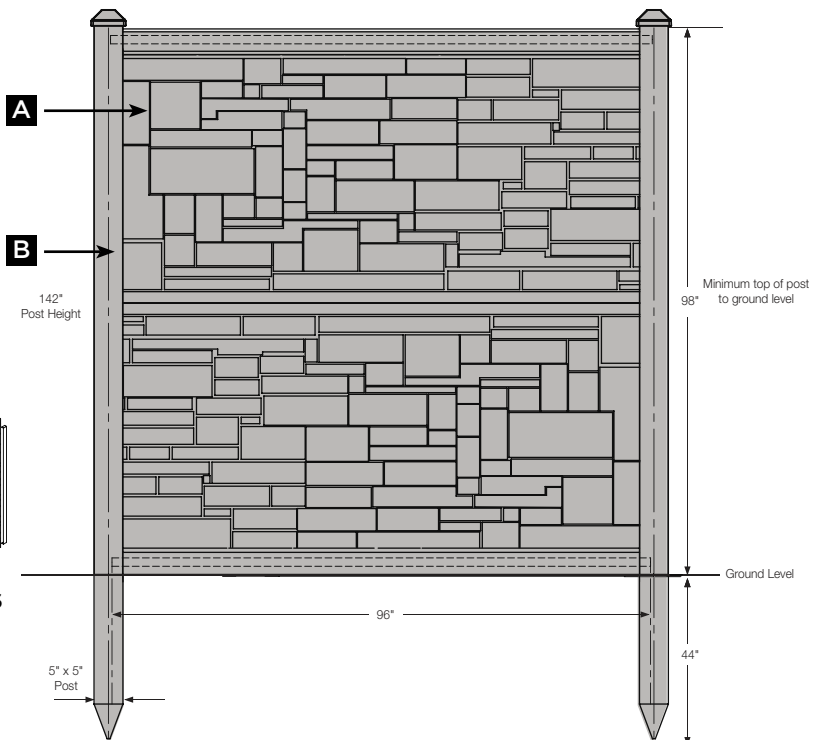
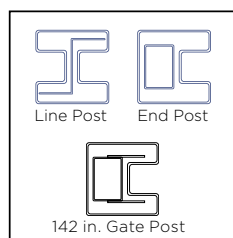
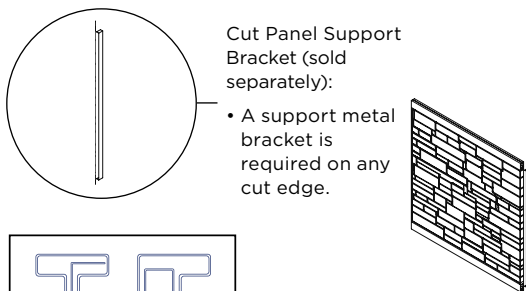

**Privacy
Sherwood**

4 ft. High / 8 ft. Wide

Select one of the available colors

- Black Granite / Black Oak
- Dark Brown Granite / Walnut Brown
- Gold Cedar
- Gray Granite / Nantucket Gray
- Red Cedar

For colors, add color letters to item number: Black Oak (BLK), Walnut Brown (DBR), Gold Cedar (GLD), Nantucket Gray (GRY), Red Cedar (RCD).

QUANTITY	PRODUCT NUMBER	DESCRIPTION
FENCE SECTIONS		
_____	SWP48X96	Sherwood Fence Panel 48 in. H x 96 in. W (For 96 in. Height order (2) 48 in. H Panel)
<i>Note: Fence section includes panel with steel reinforcement</i>		
5 IN. X 5 IN. POSTS		
_____	LP102	Line Post with Hardware 5 x 5 x 102 in.
_____	EP102	End Post with Hardware 5 x 5 x 102 in.
_____	CP102	Corner Post with Hardware 5 x 5 x 102 in.
<i>Note: Posts include panel support brackets and screws. (LP) = two brackets and two 1.5 in. screws. (CP) = two brackets, two 1.5 in. screws and four 3 in. screws. (EP) and (GP) = one bracket, one 1.25 in. screw and two 3 in. screws.</i>		
POST CAPS AND SKIRTS		
_____	PC5X5	Post Cap Square 5 in. x 5 in.
_____	PC5X10	Post Cap 45 Degree
_____	PC5X10G	Post Cap Double Inline
_____	SKIRTLP	Line Post Skirt
_____	SKIRTCP	Corner Post Skirt
_____	SKIRTEG	End Post / Gate Post Skirt
GATES (includes hinge and latch set)		
_____	SWG48X48	Sherwood Gate 48 in. high x 48 in. wide with Hardware
_____	GP102	Gate Post with Hardware 5 x 5 x 102 in.
_____	DRG36	Drop Rod Gate Hardware
OPTIONAL/EXTRA MATERIAL		
_____	GF1X42	Gap Filler 1 in. Corner/Gate Post
_____	GF2X42	Gap Filler 2 in. Line/End Post
_____	CPSB48X96	Cut Panel Support Bracket 4 ft. X 8 ft. Panels
_____	FPB	Fence Panel Bracket-Zinc
_____	CMBLP6	Concrete Mounting Bracket 24 in. Line Post 6H 8x5 Base Plate
_____	CMBEP6	Concrete Mounting Bracket 24 in. End Post 6H 6.5x5 Base Plate
_____	CMBCP6	Concrete Mounting Bracket 24 in. Corner Post 6H 7x7 Base Plate
_____	CMBGP6	Concrete Mounting Bracket 24 in. Gate Post 6H 8x5 Base Plate
_____	801401	Self Close Hinge Set Black
_____	LATCH	Combo Latch / Striker Rod Set
_____	SCREW125	SCREW 1.25 in. (14X1.25)

- A FENCE PANEL**
 PALLET QUANTITY = 20
 48" x 96"
 Includes steel channel
 in top and bottom rail
- B POST**
 PALLET QUANTITY
 Line Post = 24
 End Post = 16
 Corner Post = 16
 5" x 5" x 102"
 SUPPLIED: 5" x 5" x 102"
 FIELD CUT: 5" x 5" x 78"

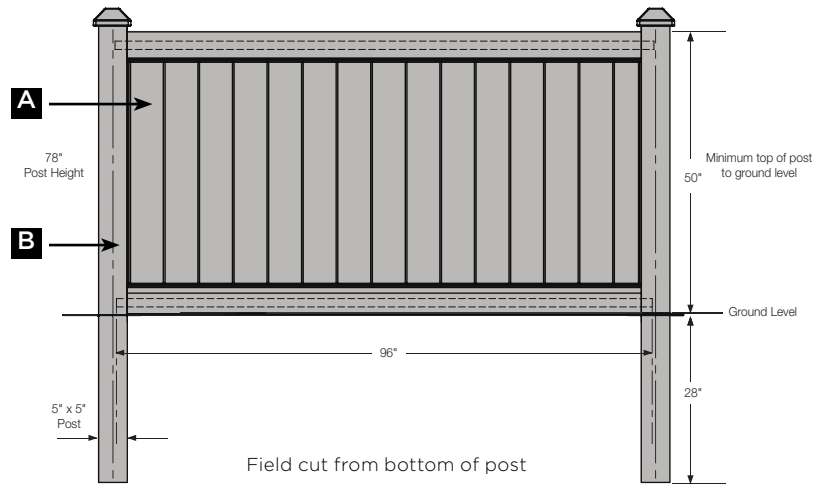
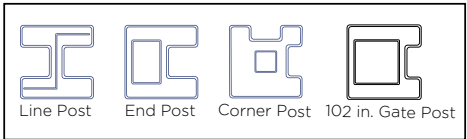

**Privacy
Sherwood**

6 ft. High / 6 ft. Wide

Select one of the available colors

- Black Granite / Black Oak
- Dark Brown Granite / Walnut Brown
- Gold Cedar
- Gray Granite / Nantucket Gray
- Red Cedar

For colors, add color letters to item number: Black Oak (BLK), Walnut Brown (DBR), Gold Cedar (GLD), Nantucket Gray (GRY), Red Cedar (RCD).

QUANTITY	PRODUCT NUMBER	DESCRIPTION
----------	----------------	-------------

FENCE SECTIONS

_____	SWP72X72	Sherwood Fence Panel 72 in. H x 72 in. W
-------	----------	--

Note: Fence section includes panel with steel reinforcement

5 IN. X 5 IN. POSTS

_____	LP102	Line Post with Hardware 5 x 5 x 102 in.
_____	EP102	End Post with Hardware 5 x 5 x 102 in.
_____	CP102	Corner Post with Hardware 5 x 5 x 102 in.

Note: Posts include panel support brackets and screws. (LP) = two brackets and two 1.5 in. screws. (CP) = two brackets, two 1.5 in. screws and four 3 in. screws. (EP) and (GP) = one bracket, one 1.25 in. screw and two 3 in. screws.

POST CAPS AND SKIRTS

_____	PC5X5	Post Cap Square 5 in. x 5 in.
_____	PC5X10	Post Cap 45 Degree
_____	PC5X10G	Post Cap Double Inline
_____	SKIRTLP	Line Post Skirt
_____	SKIRTCP	Corner Post Skirt
_____	SKIRTEG	End Post / Gate Post Skirt

GATES (includes hinge and latch set)

_____	SWGT72X36	Sherwood Gate 70 in. high x 36 in. wide with Hardware
_____	SWGT72X48	Sherwood Gate 70 in. high x 48 in. wide with Hardware
_____	SWGT72X60	Sherwood Gate 70 in. high x 60 in. wide with Hardware
_____	SWGT72X72	Sherwood Gate 70 in. high x 71 in. wide with Hardware
_____	GP102	Gate Post with Hardware 5 x 5 x 102 in.
_____	DRG36	Drop Rod Gate Hardware

OPTIONAL/EXTRA MATERIAL

_____	GF1X42	Gap Filler 1 in. Corner/Gate Post
_____	GF2X42	Gap Filler 2 in. Line/End Post
_____	CPSB72X72	Cut Panel Support Bracket 6 ft. X 6 ft. Panels
_____	FPB	Fence Panel Bracket-Zinc
_____	CMBLP6	Concrete Mounting Bracket 24 in. Line Post 6H 8x5 Base Plate
_____	CMBEP6	Concrete Mounting Bracket 24 in. End Post 6H 6.5x5 Base Plate
_____	CMBCP6	Concrete Mounting Bracket 24 in. Corner Post 6H 7x7 Base Plate
_____	CMBGP6	Concrete Mounting Bracket 24 in. Gate Post 6H 8x5 Base Plate
_____	801401	Self Close Hinge Set Black
_____	LATCH	Combo Latch / Striker Rod Set
_____	SCREW125	SCREW 1.25 in. (14X1.25)

A FENCE PANEL
 PALLET QUANTITY = 22
 72" x 72"
 Includes steel channel
 in top and bottom rail

B POST
 PALLET QUANTITY
 Line Post = 24
 End Post = 16
 Corner Post = 16
 5" x 5" x 102"

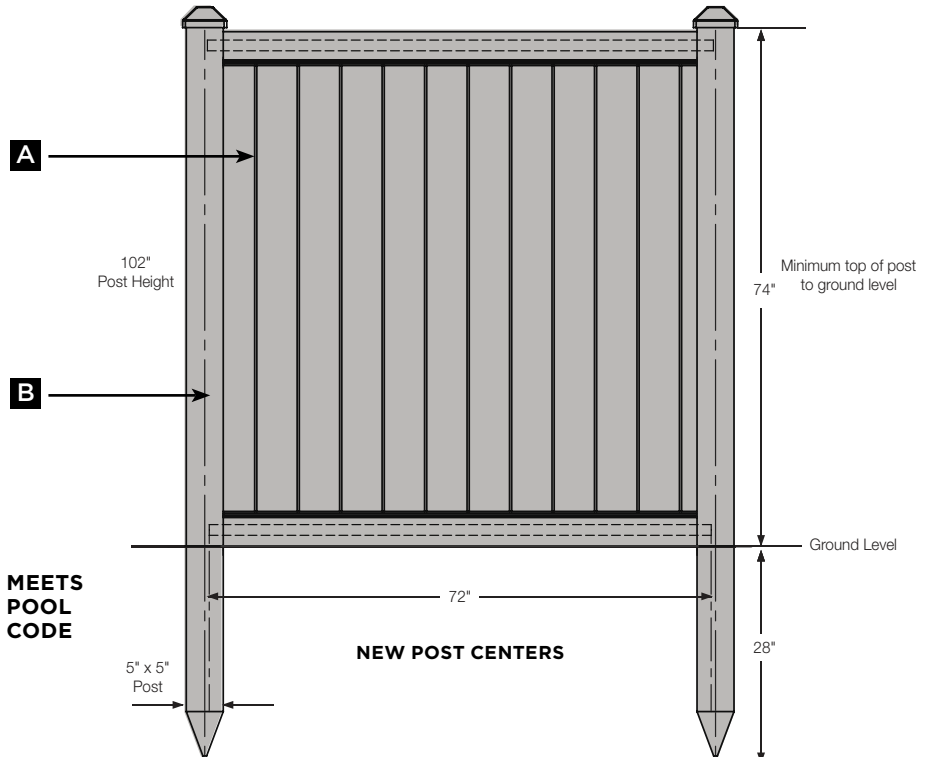
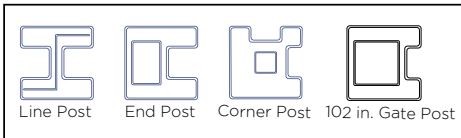

Privacy Sherwood

8 ft. High / 8 ft. Wide

Select one of the available colors

- Black Granite / Black Oak
- Dark Brown Granite / Walnut Brown
- Gold Cedar
- Gray Granite / Nantucket Gray
- Red Cedar

For colors, add color letters to item number: Black Oak (BLK), Walnut Brown (DBR), Gold Cedar (GLD), Nantucket Gray (GRY), Red Cedar (RCD).

QUANTITY	PRODUCT NUMBER	DESCRIPTION
FENCE SECTIONS		
_____	SWP48X96	Sherwood Fence Panel 48 in. H x 96 in. W (For 96 in. Height order (2) 48 in. H Panel)
<i>Note: Fence section includes panel with steel reinforcement</i>		
5 IN. X 5 IN. POSTS		
_____	LP142	Line Post with Hardware 5 x 5 x 142 in.
_____	EP142	End Post with Hardware 5 x 5 x 142 in.
<i>Note: Posts include panel support brackets and screws. (LP) = two brackets and two 1.5 in. screws. (EP) and (GP) = one bracket, one 1.25 in. screw and two 3 in. screws.</i>		
POST CAPS AND SKIRTS		
_____	PC5X5	Post Cap Square 5 in. x 5 in.
_____	PC5X10	Post Cap 45 Degree
_____	PC5X10G	Post Cap Double Inline
_____	SKIRTLP	Line Post Skirt
_____	SKIRTEG	End Post / Gate Post Skirt
GATES (includes hinge and latch set)		
_____	SWG96X48	Sherwood Gate 96 in. high x 48 in. wide with Hardware
_____	GP142	Gate Post with Hardware 5 x 5 x 142 in.
_____	DRG36	Drop Rod Gate Hardware
OPTIONAL/EXTRA MATERIAL		
_____	GF1X42	Gap Filler 1 in. Corner/Gate Post
_____	GF2X42	Gap Filler 2 in. Line/End Post
_____	CPSB48X96	Cut Panel Support Bracket 4 ft. X 8 ft. Panels
_____	FPB	Fence Panel Bracket-Zinc
_____	CMBLP8	Concrete Mounting Bracket 24 in. Line Post 8H 8x5 Base Plate
_____	CMBEP8	Concrete Mounting Bracket 24 in. End Post 8H 8x5 Base Plate
_____	801401	Self Close Hinge Set Black
_____	LATCH	Combo Latch / Striker Rod Set
_____	SCREW125	SCREW 1.25 in. (14X1.25)

A FENCE PANEL
 PALLET QUANTITY = 20
 2 - 48" x 96" panels
 Includes steel channel
 in top and bottom rail

B POST
 PALLET QUANTITY = 27
 5" x 5" x 142"

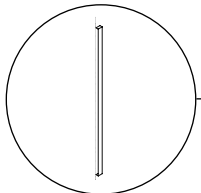

Cut Panel Support Bracket (sold separately):

- A support metal bracket is required on any cut edge.

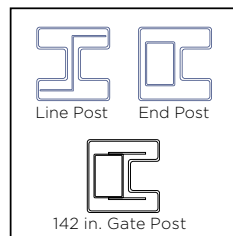
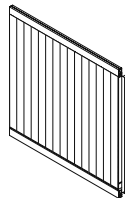

MEETS POOL CODE

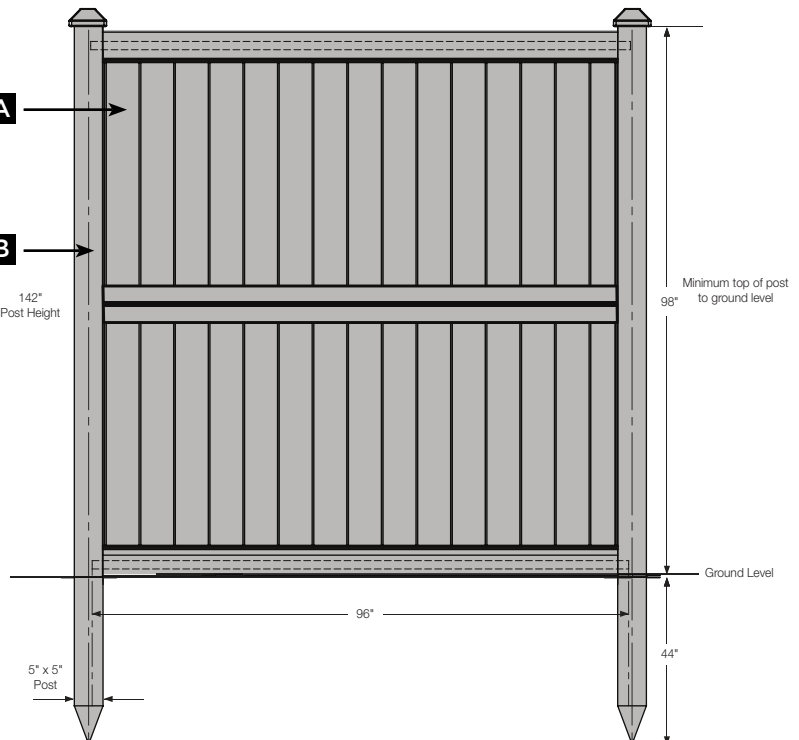

Fence Components

Molded

Select one of the available colors

- Beige Granite
- Black Granite / Black Oak
- Brown Granite
- Dark Brown Granite / Walnut Brown
- Gold Cedar
- Gray Granite / Nantucket Gray
- Red Cedar

For colors, add color letters to item number: Beige Granite (BEG), Black Granite/Black Oak (BLK), Brown Granite (BRN), Dark Brown Granite/Walnut Brown (DBR), Gold Cedar (GLD), Gray Granite/Nantucket Gray (GRY), Red Cedar (RCD).

QUANTITY	PRODUCT NUMBER	DESCRIPTION
CONCRETE MOUNTING BRACKETS		
_____	CMBLP6	Concrete Mounting Bracket 24 in. Line Post 6H 8x5 Base Plate
_____	CMBEP6	Concrete Mounting Bracket 24 in. End Post 6H 6.5x5 Base Plate
_____	CMBCP6	Concrete Mounting Bracket 24 in. Corner Post 6H 7x7 Base Plate
_____	CMBGP6	Concrete Mounting Bracket 24 in. Gate Post 6H 8x5 Base Plate
_____	CMBLP8	Concrete Mounting Bracket 24 in. Line Post 8H 8x5 Base Plate
_____	CMBEP8	Concrete Mounting Bracket 24 in. End Post 8H 8x5 Base Plate
POST CAP AND SKIRTS		
_____	PC5X5	Post Cap Square 5 in. x 5 in.
_____	PC5X10	Post Cap 45 Degree
_____	PC5X10G	Post Cap Double Inline
_____	SKIRTLP	Line Post Skirt
_____	SKIRTCP	Corner Post Skirt
_____	SKIRTEG	End Post / Gate Post Skirt
GAP FILLERS		
_____	GF1X42	Gap Filler 1 in. Corner/Gate Post
_____	GF2X42	Gap Filler 2 in. Line/End Post
<i>Note: Gap Fillers can be used to fill open channels on posts.</i>		
BRACKETS		
_____	FPB	Fence Panel Bracket-Zinc
_____	SCB	Slip Cover Bracket
_____	CPSB48X96	Cut Panel Support Bracket 4 ft. X 8 ft. Panels
_____	CPSB72X72	Cut Panel Support Bracket 6 ft. X 6 ft. Panels
<i>Note: Cut Panel Support Bracket is required on cut ends of 8'h panels.</i>		
HARDWARE		
_____	SCREW125	SCREW 1.25 in. (14X1.25)

Posts



102 in. and 142 in. Line Post



102 in. and 142 in. End Post



102 in. Corner Post

Post Caps



Single Cap

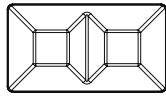

Double Inline Cap

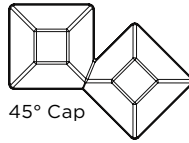

45° Cap

Gate Hardware



102 in. Gate Post



142 in. Gate Post

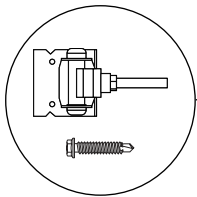

- Hinge Set (included with gate):
- 2 Hinges
 - 8 Self-tapping Screws
 - 1 Allen Wrench

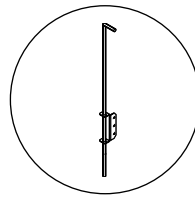

- Drop Rod Set (sold separately):
- 1 Bracket
 - 5 Screws
 - 1 Pin

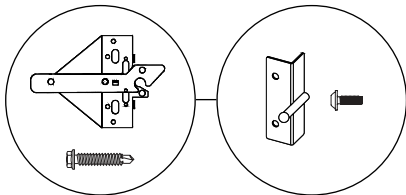

- Latch and Striker Rod Set (included with gate):
- 1 Latch, Striker Rod
 - 2 Button Head Screws
 - 6 Self-tapping Screws

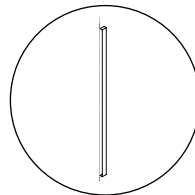

- Cut Panel Support Bracket (sold separately):
- Available for 4 ft. and 6 ft. high fence panels.

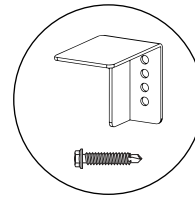
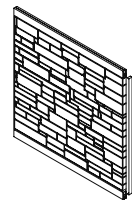

- Panel Support Brackets (included with posts)

Inside-to-Inside Post Spacing for Gates

GATE WIDTH	SINGLE OPENING	DOUBLE DRIVE WITH 3' GATE	DOUBLE DRIVE WITH 4' GATE	DOUBLE DRIVE WITH 5' GATE	DOUBLE DRIVE WITH 6' GATE
3 ft. Wide Gate	38.5"	76.0"	88.0"	100.0"	111.0"
4 ft. Wide Gate	50.5"	88.0"	100.0"	112.0"	123.0"
5 ft. Wide Gate	62.5"	100.0"	112.0"	124.0"	135.0"
6 ft. Wide Gate	73.5"	111.0"	123.0"	135.0"	146.0"

**Privacy
Brookline**

4 ft. High / 6 ft. Wide

Select one of the available colors
 ■ Almond ■ Clay ■ White

For colors, add color letters to item number: Almond (AL), Clay (C).

Note: Mixed color sections must be ordered as components; pricing will be higher than standard sections.

QUANTITY	PRODUCT NUMBER	DESCRIPTION
FENCE SECTIONS		
_____	211048	Brookline Fence Section (4 ft. x 6 ft.)
<i>Note: Fence section includes A, B, C, D and section hardware. Post and caps sold separately. POST CENTERS ARE 6 FT. 5 IN. X 5 IN. POSTS</i>		
_____	67541	Brookline Corner Post 5 in. x 5 in. x 84 in.
_____	67542	Brookline Line Post 5 in. x 5 in. x 84 in.
_____	67543	Brookline End Post 5 in. x 5 in. x 84 in.
_____	539084	Blank Post 5 in. x 5 in. x 84 in.
POST CAPS		
_____	70493	Ball Cap 5 in. x 5 in.
_____	70416	Gothic Cap Ext 5 in. x 5 in.
_____	70418	Flat Cap Ext 5 in. x 5 in.
_____	70427	New England Cap Ext 5 in. x 5 in.
GATES (hardware ordered separately)		
_____	42787	Brookline Gate Kit (builds up to 50-1/2 in. wide gate)
_____	70027	Gate Extension Kit (builds up to 70 in. gate) gate kit must also be ordered
_____	437187	Brookline Preassembled Gate 50-1/2 in. wide
_____	70095	Aluminum 5 in. x 5 in. x 94 in. Gate Post Stiffener
_____	27635	Drop Pin Kit
_____	27742	5 ft. to 6 ft. Height Gate Hardware (self-closing hinges and latch)
_____	27745	Deluxe Key Entry Nylon Gate Hardware (5 ft. and 6 ft. height fence)
_____	27752	Plus Key Entry Nylon Gate Hardware (5 ft. and 6 ft. height fence)
_____	27747	LokkLatch Magnetic Gate Hardware (5 ft. and 6 ft. height fence)
_____	27731	Standard Stainless Steel Gate Hardware Pebble Black Finish
<i>Note: Gate kits include (2) 2-1/2 in. x 4 in. up-rights, caps and screws. Rails and pickets ordered separately.</i>		
OPTIONAL/EXTRA MATERIAL		
_____	70070	Optional Steel Reinforcement Channel x 71 in. for 2 in. x 6 in. Rail
_____	619071	Brookline Deco Top Rail 2 in. x 6 in. x 71 in.
_____	614871	Brookline Deco Top/Bottom Rail with Steel 2 in. x 6 in. x 71 in.
_____	60783P	Lock Rings (order 2 per rail) Qty: 24
_____	469067	Brookline 7/8 in. x 7 in. x 66-1/2 in. Tongue and Groove Picket
_____	71414	2 in. EZ Set Post Brackets (pair with hardware - optional)
_____	70169	Aluminum End Channel 1 in. x 1-1/2 in. x 60-1/2 in.

Note: End channels must be attached to posts.

A TOP RAIL

PALLET QUANTITY = 84
 2" x 6" x 71" Deco Rail Ribbed.
 Note: Clay color includes steel in top rail

B PICKETS

PALLET QUANTITY = 162
 5 pickets per section of
 7/8" x 7" x 66-1/2"

C END CHANNEL

SUPPLIED: 1" x 1-1/2" x 60-1/2"
 FIELD CUT: 1" x 1-1/2" x 32-1/2"

D BOTTOM RAIL

PALLET QUANTITY = 84
 2" x 6" x 71" Deco Rail Ribbed. Includes
 steel channel.

E POST

PALLET QUANTITY = 48
 5" x 5" x 84"

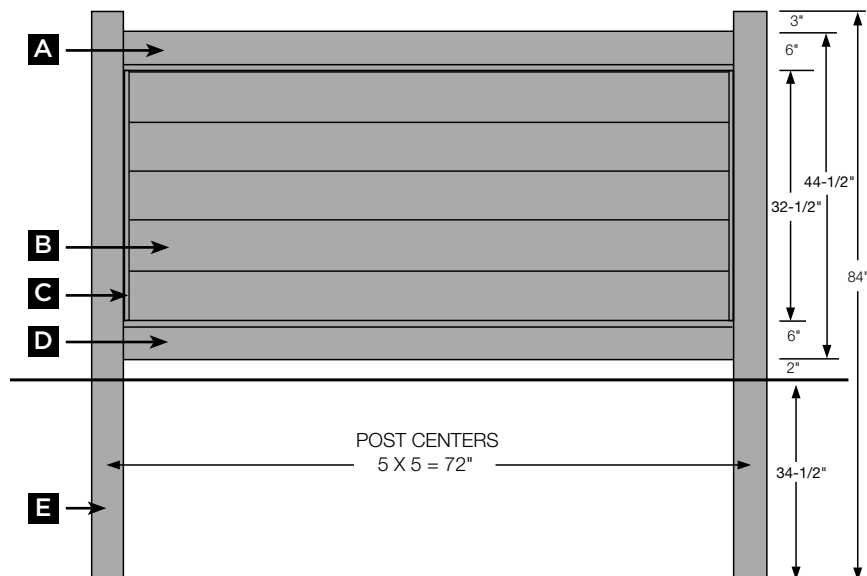

**Privacy
Brookline**

5 ft. High / 6 ft. Wide

Select one of the available colors
 ■ Almond ■ Clay ■ White

For colors, add color letters to item number: Almond (AL), Clay (C).

Note: Mixed color sections must be ordered as components; pricing will be higher than standard sections.

QUANTITY	PRODUCT NUMBER	DESCRIPTION
FENCE SECTIONS		
_____	211060	Brookline Fence Section (5 ft. x 6 ft.)
<i>Note: Fence section includes A, B, C, D and section hardware. Post and caps sold separately. POST CENTERS ARE 6 FT.</i>		
5 IN. X 5 IN. POSTS		
_____	67551	Brookline Corner Post 5 in. x 5 in. x 96 in.
_____	67552	Brookline Line Post 5 in. x 5 in. x 96 in.
_____	67553	Brookline End Post 5 in. x 5 in. x 96 in.
_____	679096	Blank Post Heavy Wall 5 in. x 5 in. x 96 in.
POST CAPS		
_____	70493	Ball Cap 5 in. x 5 in.
_____	70416	Gothic Cap Ext 5 in. x 5 in.
_____	70418	Flat Cap Ext 5 in. x 5 in.
_____	70427	New England Cap Ext 5 in. x 5 in.
GATES (hardware ordered separately)		
_____	42788	Brookline Gate Kit (builds up to 50-1/2 in. wide gate)
_____	70027	Gate Extension Kit (builds up to 70 in. gate) gate kit must also be ordered
_____	437188	Brookline Preassembled Gate 50-1/2 in. wide
_____	70095	Aluminum 5 in. x 5 in. x 94 in. Gate Post Stiffener
_____	27635	Drop Pin Kit
_____	27742	5 ft. to 6 ft. Height Gate Hardware (self-closing hinges and latch)
_____	27745	Deluxe Key Entry Nylon Gate Hardware (5 ft. and 6 ft. height fence)
_____	27752	Plus Key Entry Nylon Gate Hardware (5 ft. and 6 ft. height fence)
_____	27747	LokkLatch Magnetic Gate Hardware (5 ft. and 6 ft. height fence)
_____	27731	Standard Stainless Steel Gate Hardware Pebble Black Finish
<i>Note: Gate kits include (2) 2-1/2 in. x 4 in. up-rights, caps and screws. Rails and pickets ordered separately.</i>		
OPTIONAL/EXTRA MATERIAL		
_____	70070	Optional Steel Reinforcement Channel x 71 in. for 2 in. x 6 in. Rail
_____	619071	Brookline Deco Top Rail 2 in. x 6 in. x 71 in.
_____	614871	Brookline Deco Top/Bottom Rail with Steel 2 in. x 6 in. x 71 in.
_____	60783P	Lock Rings (order 2 per rail) Qty: 24
_____	469067	Brookline 7/8 in. x 7 in. x 66-1/2 in. Tongue and Groove Picket
_____	71414	2 in. EZ Set Post Brackets (pair with hardware - optional)
_____	70169	Aluminum End Channel 1 in. x 1-1/2 in. x 60-1/2 in.

Note: End channels must be attached to posts.

- A TOP RAIL** PALLET QUANTITY = 84
2" x 6" x 71" Deco rail ribbed.
Note: Clay color includes steel in top rail
- B PICKETS** PALLET QUANTITY = 162
7 pickets per section of 7/8" x 7" x 66-1/2"
- C END CHANNEL**
SUPPLIED: 1" x 1-1/2" x 60-1/2"
FIELD CUT: 1" x 1-1/2" x 46-1/2"
- D BOTTOM RAIL** PALLET QUANTITY = 84
2" x 6" x 71" Deco rail ribbed.
Includes steel channel.
- E POST** PALLET QUANTITY = 48
5" x 5" x 96"



**MEETS
POOL
CODE**

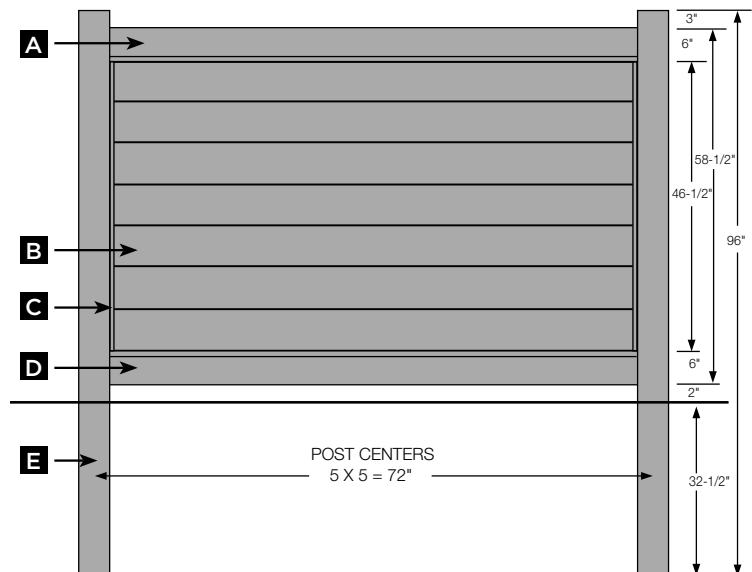

For colors, add color letters to item number: Almond (AL), Clay (C).

Note: Mixed color sections must be ordered as components; pricing will be higher than standard sections.

QUANTITY	PRODUCT NUMBER	DESCRIPTION
FENCE SECTIONS		
_____	211072	Brookline Fence Section (6 ft. x 6 ft.)

Note: Fence section includes A, B, C, D and section hardware. Post and caps sold separately. POST CENTERS ARE 6 FT. 5 IN. X 5 IN. POSTS

_____	67561	Brookline Corner Post 5 in. x 5 in. x 107 in.
_____	67562	Brookline Line Post 5 in. x 5 in. x 107 in.
_____	71106	Aluminum 5 in. x 5 in. x 106 in. Line Post Stiffener
_____	67563	Brookline End Post 5 in. x 5 in. x 107 in.
_____	679108	Blank Post Heavy Wall 5 in. x 5 in. x 107 in.

POST CAPS		
_____	70493	Ball Cap 5 in. x 5 in.
_____	70416	Gothic Cap Ext 5 in. x 5 in.
_____	70418	Flat Cap Ext 5 in. x 5 in.
_____	70427	New England Cap Ext 5 in. x 5 in.

GATES (hardware ordered separately)		
_____	42789	Brookline Gate Kit (builds up to 50-1/2 in. wide gate)
_____	70027	Gate Extension Kit (builds up to 70 in. gate) gate kit must also be ordered
_____	70106	Aluminum 5 in. x 5 in. x 106 in. Gate Post Stiffener
_____	437189	Brookline Preassembled Gate 50-1/2 in. wide
_____	27635	Drop Pin Kit
_____	27742	5 ft. to 6 ft. Height Gate Hardware (self-closing hinges and latch)
_____	27745	Deluxe Key Entry Nylon Gate Hardware (5 ft. and 6 ft. height fence)
_____	27752	Plus Key Entry Nylon Gate Hardware (5 ft. and 6 ft. height fence)
_____	27747	LokkLatch Magnetic Gate Hardware (5 ft. and 6 ft. height fence)
_____	27731	Standard Stainless Steel Gate Hardware Pebble Black Finish

Note: Gate kits include (2) 2-1/2 in. x 4 in. up-rights, caps and screws. Rails and pickets ordered separately.

OPTIONAL/EXTRA MATERIAL		
_____	70070	Optional Steel Reinforcement Channel x 71 in. for 2 in. x 6 in. Rail
_____	619071	Brookline Deco Top Rail 2 in. x 6 in. x 71 in.
_____	614871	Brookline Deco Top/Bottom Rail with Steel 2 in. x 6 in. x 71 in.
_____	60783P	Lock Rings (order 2 per rail) Qty: 24
_____	469067	Brookline 7/8 in. x 7 in. x 66-1/2 in. Tongue and Groove Picket
_____	71414	2 in. EZ Set Post Brackets (pair with hardware - optional)
_____	70169	Aluminum End Channel 1 in. x 1-1/2 in. x 60-1/2 in.

Note: End channels must be attached to posts.

- A TOP RAIL** PALLET QUANTITY = 84
2" x 6" x 71" Deco rail ribbed.
Note: Clay color includes steel in top rail
- B PICKETS** PALLET QUANTITY = 162
9 pickets per section of 7/8" x 7" x 66-1/2"
- C END CHANNEL**
1" x 1-1/2" x 60-1/2"
- D BOTTOM RAIL** PALLET QUANTITY = 84
2" x 6" x 71" Deco rail ribbed.
Includes steel channel.
- E POST** PALLET QUANTITY = 48
5" x 5" x 107"

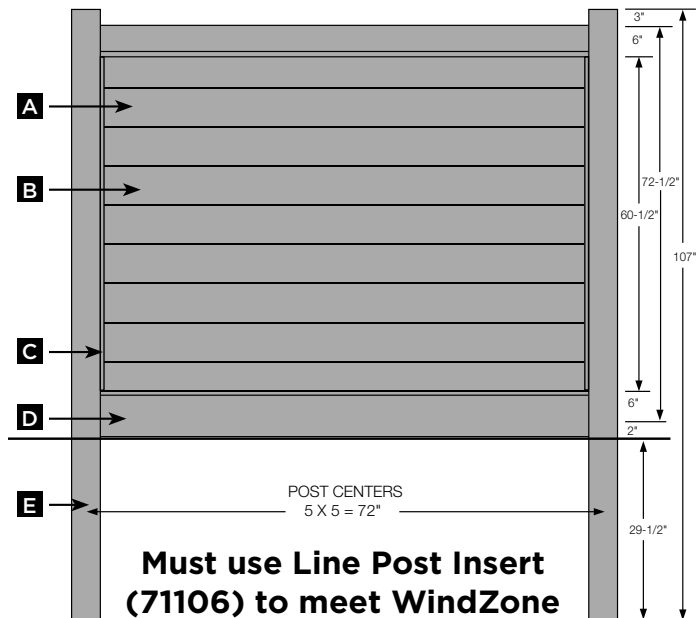

Must use Line Post Insert (71106) to meet WindZone



**FEATURING
WINDZONE
TECHNOLOGY**



**MEETS
POOL
CODE**

**Privacy
Brookline with CertaGrain
Texture**

4 ft. High / 6 ft. Wide

Select one of the available colors
 ■ Arctic Blend ■ Brazilian Blend
 ■ Sierra Blend ■ Weathered Blend

For colors, add color letters to item number: Arctic Blend (AC4), Brazilian Blend (BR4), Sierra Blend (SB4), Weathered Blend (WB4).

Note: Mixed color sections must be ordered as components; pricing will be higher than standard sections.

QUANTITY	PRODUCT NUMBER	DESCRIPTION
FENCE SECTIONS		
_____	31148	Brookline Fence Section with CertaGrain Texture (4 ft. x 6 ft.)
<i>Note: Fence section includes A, B, C, D and section hardware. Post and caps sold separately. POST CENTERS ARE 6 FT.</i>		
5 IN. X 5 IN. POSTS		
_____	75841	CertaGrain Corner Post 5 in. x 5 in. x 84 in.
_____	75842	CertaGrain Line Post 5 in. x 5 in. x 84 in.
_____	75843	CertaGrain End Post 5 in. x 5 in. x 84 in.
_____	759084	CertaGrain Blank Post 5 in. x 5 in. x 84 in.
POST CAPS		
_____	70444	CertaGrain Flat Top Cap Ext 5 in. x 5 in.
_____	70459	Textured New England Cap 5 in. x 5 in.
GATES (hardware ordered separately)		
_____	31887	Brookline CertaGrain Gate Kit (builds up to 50-1/2 in. wide gate)
_____	70027	Gate Extension Kit (builds up to 70 in. gate) gate kit must also be ordered
_____	328087	Brookline CertaGrain Preassembled Gate 50-1/2 in. wide
_____	70095	Aluminum 5 in. x 5 in. x 94 in. Gate Post Stiffener
_____	27635	Drop Pin Kit
_____	27742	5 ft. to 6 ft. Height Gate Hardware (self-closing hinges and latch)
_____	27745	Deluxe Key Entry Nylon Gate Hardware (5 ft. and 6 ft. height fence)
_____	27752	Plus Key Entry Nylon Gate Hardware (5 ft. and 6 ft. height fence)
_____	27747	LokkLatch Magnetic Gate Hardware (5 ft. and 6 ft. height fence)
_____	27731	Standard Stainless Steel Gate Hardware Pebble Black Finish
<i>Note: Gate kits include (2) 2-1/2 in. x 4 in. up-rights, caps and screws. Rails and pickets ordered separately.</i>		
OPTIONAL/EXTRA MATERIAL		
_____	70070	Optional Steel Reinforcement Channel x 71 in. for 2 in. x 6 in. Rail
_____	744071	Brookline CertaGrain Top/Bottom Rail with Steel 2 in. x 6 in. x 71 in.
_____	60783P	Lock Rings (order 2 per rail) Qty: 24
_____	769067	Brookline CertaGrain 7/8 in. x 7 in. x 66-1/2 in. Tongue and Groove Picket
_____	71414	2 in. EZ Set Post Brackets (pair with hardware - optional)
_____	70169	Aluminum End Channel 1 in. x 1-1/2 in. x 60-1/2 in.

Note: End channels must be attached to posts.

- A TOP RAIL** PALLET QUANTITY = 84
2" x 6" x 71" rail ribbed.
Note: Arctic Blend, Brazilian Blend, Sierra Blend, and Weathered Blend colors include steel in top rail.
- B PICKETS** PALLET QUANTITY = 162
5 pickets per section of 7/8" x 7" x 66-1/2"
- C END CHANNEL**
SUPPLIED: 1" x 1-1/2" x 60-1/2"
FIELD CUT: 1" x 1-1/2" x 32-1/2"
- D BOTTOM RAIL** PALLET QUANTITY = 84
2" x 6" x 71" rail ribbed.
Includes steel channel.
- E POST** PALLET QUANTITY = 48
5" x 5" x 84"

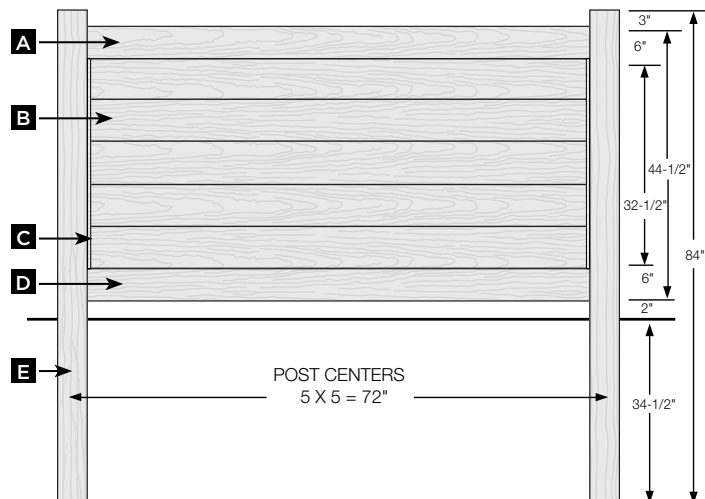

**Privacy
Brookline with CertaGrain
Texture**

5 ft. High / 6 ft. Wide

Select one of the available colors

- Arctic Blend ■ Brazilian Blend
- Sierra Blend ■ Weathered Blend

For colors, add color letters to item number: Arctic Blend (AC4), Brazilian Blend (BR4), Sierra Blend (SB4), Weathered Blend (WB4).

Note: Mixed color sections must be ordered as components; pricing will be higher than standard sections.

QUANTITY	PRODUCT NUMBER	DESCRIPTION
FENCE SECTIONS		
_____	31160	Brookline Fence Section with CeratGrain Texture (5 ft. x 6 ft.)
<i>Note: Fence section includes A, B, C, D and section hardware. Post and caps sold separately. POST CENTERS ARE 6 FT.</i>		
5 IN. X 5 IN. POSTS		
_____	75851	CertaGrain Corner Post 5 in. x 5 in. x 96 in.
_____	75852	CertaGrain Line Post 5 in. x 5 in. x 96 in.
_____	75853	CertaGrain End Post 5 in. x 5 in. x 96 in.
_____	759096	CertaGrain Blank Post Heavy Wall 5 in. x 5 in. x 96 in.
POST CAPS		
_____	70444	CertaGrain Flat Top Cap Ext 5 in. x 5 in.
_____	70459	Textured New England Cap 5 in. x 5 in.
GATES (hardware ordered separately)		
_____	31888	Brookline CertaGrain Gate Kit (builds up to 50-1/2 in. wide gate)
_____	70027	Gate Extension Kit (builds up to 70 in. gate) gate kit must also be ordered
_____	328088	Brookline CertaGrain Preassembled Gate 50-1/2 in. wide
_____	70095	Aluminum 5 in. x 5 in. x 94 in. Gate Post Stiffener
_____	27635	Drop Pin Kit
_____	27742	5 ft. to 6 ft. Height Gate Hardware (self-closing hinges and latch)
_____	27745	Deluxe Key Entry Nylon Gate Hardware (5 ft. and 6 ft. height fence)
_____	27752	Plus Key Entry Nylon Gate Hardware (5 ft. and 6 ft. height fence)
_____	27747	LokkLatch Magnetic Gate Hardware (5 ft. and 6 ft. height fence)
_____	27731	Standard Stainless Steel Gate Hardware Pebble Black Finish
<i>Note: Gate kits include (2) 2-1/2 in. x 4 in. up-rights, caps and screws. Rails and pickets ordered separately.</i>		
OPTIONAL/EXTRA MATERIAL		
_____	70070	Optional Steel Reinforcement Channel x 71 in. for 2 in. x 6 in. Rail
_____	744071	Brookline CertaGrain Top/Bottom Rail with Steel 2 in. x 6 in. x 71 in.
_____	60783P	Lock Rings (order 2 per rail) Qty: 24
_____	769067	Brookline CertaGrain 7/8 in. x 7 in. x 66-1/2 in. Tongue and Groove Picket
_____	71414	2 in. EZ Set Post Brackets (pair with hardware - optional)
_____	70169	Aluminum End Channel 1 in. x 1-1/2 in. x 60-1/2 in.

Note: End channels must be attached to posts.

- A TOP RAIL** PALLET QUANTITY = 84
2" x 6" x 71" rail ribbed.
Note: Arctic Blend, Brazilian Blend, Sierra Blend, and Weathered Blend colors include steel in top rail.
- B PICKETS** PALLET QUANTITY = 162
7 pickets per section of 7/8" x 7" x 66-1/2"
- C END CHANNEL**
SUPPLIED: 1" x 1-1/2" x 60-1/2"
FIELD CUT: 1" x 1-1/2" x 46-1/2"
- D BOTTOM RAIL**
PALLET QUANTITY = 84
2" x 6" x 71" rail ribbed.
Includes steel channel.
- E POST** PALLET QUANTITY = 48
5" x 5" x 96"



**MEETS
POOL
CODE**

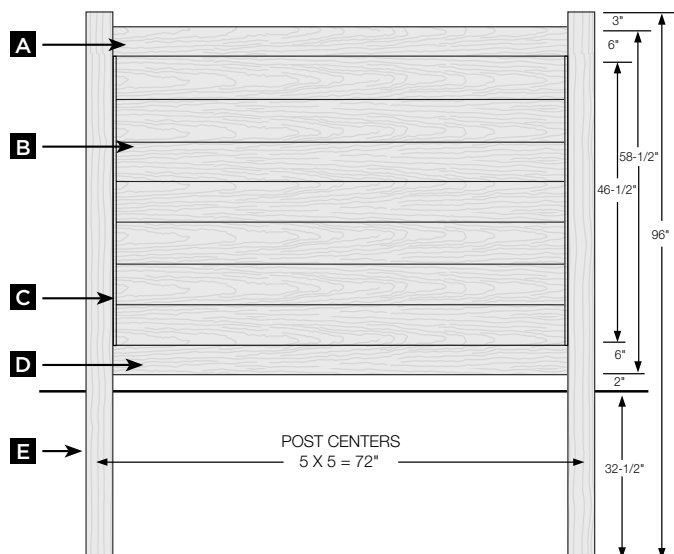

**Privacy
Brookline with CertaGrain
Texture**

6 ft. High / 6 ft. Wide

Select one of the available colors
 ■ Arctic Blend ■ Brazilian Blend
 ■ Sierra Blend ■ Weathered Blend

For colors, add color letters to item number: Arctic Blend (AC4), Brazilian Blend (BR4), Sierra Blend (SB4), Weathered Blend (WB4).

Note: Mixed color sections must be ordered as components; pricing will be higher than standard sections.

QUANTITY	PRODUCT NUMBER	DESCRIPTION
FENCE SECTIONS		
_____	31172	Brookline Fence Section with CertaGrain Texture (6 ft. x 6 ft.)

Note: Fence Section Includes A, B, C and D and section hardware. Post and Caps sold separately. POST CENTERS ARE 6 FT.

5 IN. X 5 IN. POSTS		
_____	75861	CertaGrain Corner Post 5 in. x 5 in. x 107 in.
_____	75862	CertaGrain Line Post 5 in. x 5 in. x 107 in.
_____	71106	Aluminum 5 in. x 5 in. x 106 in. Line Post Stiffener
_____	75863	CertaGrain End Post 5 in. x 5 in. x 107 in.
_____	759108	CertaGrain Blank Post Heavy Wall 5 in. x 5 in. x 107 in.

POST CAPS		
_____	70444	CertaGrain Flat Top Cap Ext 5 in. x 5 in.
_____	70459	Textured New England Cap 5 in. x 5 in.

GATES (Hardware ordered separately)		
_____	31889	Brookline CertaGrain Gate Kit (builds up to 50-1/2 in. wide gate)
_____	70027	Gate Extension Kit (builds up to 70 in. gate) gate kit must also be ordered
_____	328089	Brookline CertaGrain Preassembled Gate 50-1/2 in. wide
_____	70106	Aluminum 5 in. x 5 in. x 106 in. Gate Post Stiffener
_____	27635	Drop Pin Kit
_____	27742	5 ft. to 6 ft. Height Gate Hardware (self-closing hinges and latch)
_____	27745	Deluxe Key Entry Nylon Gate Hardware (5 ft. and 6 ft. height fence)
_____	27752	Plus Key Entry Nylon Gate Hardware (5 ft. and 6 ft. height fence)
_____	27747	LokkLatch Magnetic Gate Hardware (5 ft. and 6 ft. height fence)
_____	27731	Standard Stainless Steel Gate Hardware Pebble Black Finish

Note: Gate kits include (2) 2-1/2 x 4 up-rights, caps, and screws. Rails and pickets ordered separately.

OPTIONAL/EXTRA MATERIAL		
_____	70070	Optional Steel Reinforcement Channel x 71 in. for 2 in. x 6 in. Rail
_____	744071	Brookline CertaGrain Top/Bottom Rail with Steel 2 in. x 6 in. x 71 in.
_____	60783P	Lock Rings (order 2 per rail) Qty: 24
_____	769067	Brookline CertaGrain 7/8 in. x 7 in. x 66-1/2 in. Tongue and Groove Picket
_____	71414	2 in. EZ Set Post Brackets (pair with hardware - optional)
_____	70169	Aluminum End Channel 1 in. x 1-1/2 in. x 60-1/2 in.

Note: End channels must be attached to posts.

- A TOP RAIL** PALLET QUANTITY = 84
2" x 6" x 71" rail ribbed.
Note: Arctic Blend, Brazilian Blend, Sierra Blend and Weathered Blend colors include steel in top rail.
- B PICKETS** PALLET QUANTITY = 162
9 pickets per section of 7/8" x 7" x 66-1/2"
- C END CHANNEL**
1" x 1-1/2" x 60-1/2"
- D BOTTOM RAIL**
PALLET QUANTITY = 84
2" x 6" x 71" rail ribbed.
Includes steel channel.
- E POST** PALLET QUANTITY = 48
5" x 5" x 107"



**FEATURING
WINDZONE
TECHNOLOGY**



**MEETS
POOL
CODE**

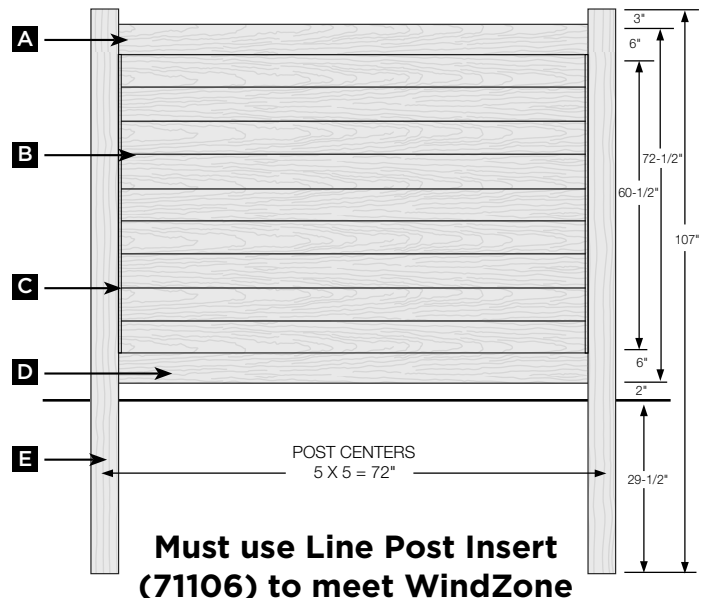

**Privacy
Chesterfield**

4 ft. High / 8 ft. Wide

Select one of the available colors
 Almond White

For Almond, add (AL) to item number.

Note: Mixed color sections must be ordered as components; pricing will be higher than standard sections.

QUANTITY	PRODUCT NUMBER	DESCRIPTION
FENCE SECTIONS		
_____	210479	Chesterfield Fence Section (4 ft. x 8 ft.)

Note: Fence section includes A, B, C, D and section hardware. Post and caps sold separately.

5 IN. X 5 IN. POSTS		
_____	642715	Corner Post 5 in. x 5 in. x 84 in.
_____	642725	Line Post 5 in. x 5 in. x 84 in.
_____	642735	End Post 5 in. x 5 in. x 84 in.
_____	539084	Blank Post 5 in. x 5 in. x 84 in.

POST CAPS		
_____	70417	Flat Cap Int 5 in. x 5 in.
_____	70493	Ball Cap 5 in. x 5 in.
_____	70416	Gothic Cap Ext 5 in. x 5 in.
_____	70418	Flat Cap Ext 5 in. x 5 in.
_____	70427	New England Cap Ext 5 in. x 5 in.

GATES (hardware ordered separately)		
_____	42721	Gate Kit (builds up to 50-1/2 in. wide gate)
_____	70027	Gate Extension Kit (builds up to 70 in. gate) gate kit must also be ordered
_____	437052	Preassembled Gate 50-1/2 in. Wide
_____	70095	Aluminum 5 in. x 5 in. x 94 in. Gate Post Stiffener
_____	27635	Drop Pin Kit
_____	27742	5 ft. to 6 ft. Height Gate Hardware (self-closing hinges and latch)
_____	27745	Deluxe Key Entry Nylon Gate Hardware (5 ft. and 6 ft. height fence)
_____	27752	Plus Key Entry Nylon Gate Hardware (5 ft. and 6 ft. height fence)
_____	27747	LokkLatch Magnetic Gate Hardware (5 ft. and 6 ft. height fence)
_____	27731	Standard Stainless Steel Gate Hardware Pebble Black Finish

Note: Gate kits include (2) 2-1/2 in. x 4 in. up-rights, caps and screws. Rails and pickets ordered separately.

OPTIONAL/EXTRA MATERIAL		
_____	70090	Steel Reinforcement Channel x 92 in. for 2 in. x 6 in. Rail
_____	619095	Chesterfield Deco Channeled Top Rail 2 in. x 6 in. x 95 in.
_____	614895	2 in. x 6 in. x 95 in. Deco Top/Bottom Rail with Steel
_____	60783P	Lock Rings (order 2 per rail) Qty: 24
_____	469040F	Fence Fill Kit 7/8 in. x 7 in. x 39-1/4 in. Tongue and Groove (13 pc)
_____	71414	2 in. EZ Set Post Brackets (pair with hardware - optional)
_____	16959	End Channel 7/8 in. x 1 in. x 59-7/8 in.

Note: End channels must be attached to posts.

- A TOP RAIL**
 PALLET QUANTITY = 84
 2" x 6" x 95" Deco Rail Ribbed.
- B PICKETS**
 PALLET QUANTITY = 12 Fill Kits
 Section includes 13 pickets of
 7/8" x 7" x 39-1/4"
- C END CHANNEL**
 SUPPLIED: 7/8" x 1" x 59-7/8"
 FIELD CUT: 7/8" x 1" x 36-3/8"
- D BOTTOM RAIL**
 PALLET QUANTITY = 84
 2" x 6" x 95" Deco Rail Ribbed.
 Includes steel channel.
- E POST** PALLET QUANTITY = 48
 5" x 5" x 84"



**Racks up to
10 degrees**

**MEETS
POOL
CODE**

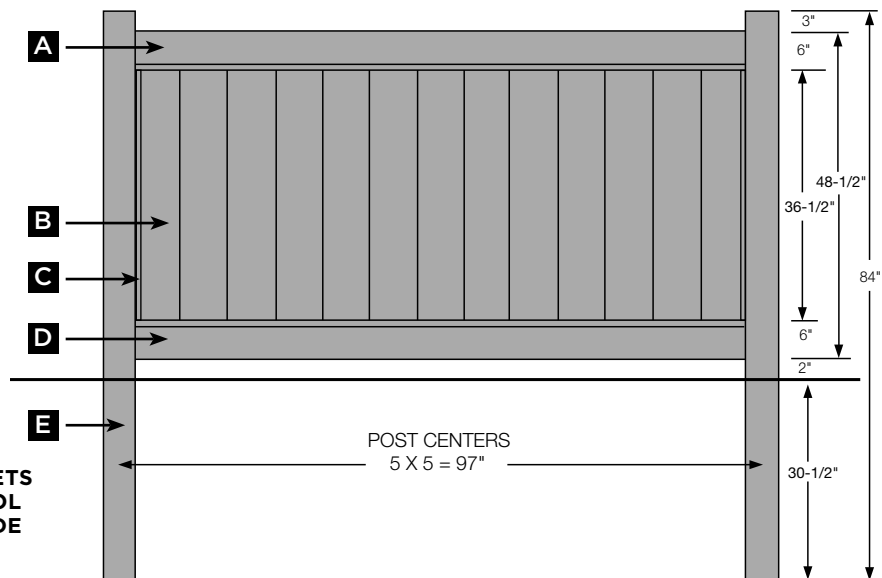

**Privacy
Chesterfield with Lattice
Accent**

5 ft. High / 8 ft. Wide

Select one of the available colors
 Almond White

For Almond, add (AL) to item number.

Note: Mixed color sections must be ordered as components; pricing will be higher than standard sections.

QUANTITY	PRODUCT NUMBER	DESCRIPTION
FENCE SECTIONS		
_____	22055	Chesterfield Fence Section with Lattice Accent (5 ft. x 8 ft.)
<i>Note: Fence section includes A, B, C, D, E, F, G, H and section hardware. Post and caps sold separately.</i>		
5 IN. X 5 IN. POSTS		
_____	68011	Corner Post 5 in. x 5 in. x 96 in.
_____	68012	Line Post 5 in. x 5 in. x 96 in.
_____	71106	Aluminum 5 in. x 5 in. x 106 in. Line Post Stiffener
_____	68013	End Post 5 in. x 5 in. x 96 in.
_____	679096	Blank Post Heavy Wall 5 in. x 5 in. x 96 in.
POST CAPS		
_____	70493	Ball Cap 5 in. x 5 in.
_____	70416	Gothic Cap Ext 5 in. x 5 in.
_____	70418	Flat Cap Ext 5 in. x 5 in.
_____	70427	New England Cap Ext 5 in. x 5 in.
GATES (hardware ordered separately)		
_____	42722	Gate Kit with Accent (builds up to 50-1/2 in. wide gate)
_____	70027	Gate Extension Kit (builds up to 70 in. gate) gate kit must also be ordered
_____	437053	Preassembled Gate with Lattice Accent 50-1/2 in. Wide
_____	70095	Aluminum 5 in. x 5 in. x 94 in. Gate Post Stiffener
_____	27635	Drop Pin Kit
_____	27742	5 ft. to 6 ft. Height Gate Hardware (self-closing hinges and latch)
_____	27745	Deluxe Key Entry Nylon Gate Hardware (5 ft. and 6 ft. height fence)
_____	27752	Plus Key Entry Nylon Gate Hardware (5 ft. and 6 ft. height fence)
_____	27747	LokkLatch Magnetic Gate Hardware (5 ft. and 6 ft. height fence)
_____	27731	Standard Stainless Steel Gate Hardware Pebble Black Finish
<i>Note: Gate kits include (2) 2-1/2 in. x 4 in. up-rights, caps and screws. Rails and pickets ordered separately.</i>		
OPTIONAL/EXTRA MATERIAL		
_____	70090	Steel Reinforcement Channel x 92 in. for 2 in. x 6 in. Rail
_____	619095	Chesterfield Deco Channeled Top Rail 2 in. x 6 in. x 95 in.
_____	614895	2 in. x 6 in. x 95 in. Deco Top/Bottom Rail with Steel
_____	290095	2 in. x 3-1/2 in. x 95 in. Accent Rail
_____	60783P	Lock Rings (order 2 per rail) Qty: 24
_____	469034F	Fence Fill Kit 7/8 in. x 7 in. x 33 1/2 in. Tongue and Groove (13 pc)
_____	444129	13 in. x 91-1/2 in. Lattice Insert (diagonal)
_____	17991	Horizontal Channel for Lattice 5/8 in. x 1 in. x 90-3/4 in.
_____	17913	Vertical Channel for Lattice 5/8 in. x 1 in. x 13-1/8 in.
_____	71414	2 in. EZ Set Post Brackets (pair with hardware - optional)
_____	16959	End Channel 7/8 in. x 1 in. x 59-7/8 in.

Note: End channels must be attached to posts.

- A TOP ACCENT RAIL**
 PALLET QUANTITY = 120
 2" x 3-1/2" x 95"
- B LATTICE PANEL**
 1 piece of 13" x 91-1/2"
 1-1/4" x 1/4" strips
- C VERTICAL CHANNEL**
 2 pieces of 5/8" x 1" x 13-1/8"
- D HORIZONTAL CHANNEL**
 2 pieces of 5/8" x 1" x 90-3/4"
- E TOP RAIL PALLET**
 QUANTITY = 84
 2" x 6" x 95" Deco rail ribbed.
- F PICKETS** PALLET QUANTITY =
 12 Fill Kits 7/8" x 7" x 33-1/2"
 Section includes 13 pickets.

- G END CHANNEL**
 SUPPLIED:
 7/8" x 1" x 59-7/8"
 FIELD CUT: 7/8" x 1" x 31"
- H BOTTOM RAIL**
 PALLET QUANTITY = 84
 2" x 6" x 95" Deco rail
 ribbed.
 Includes steel channel.
- I POST**
 PALLET QUANTITY = 48
 5" x 5" x 96"

Racks up to 10 degrees*
***Accents will reduce the degree of rack**

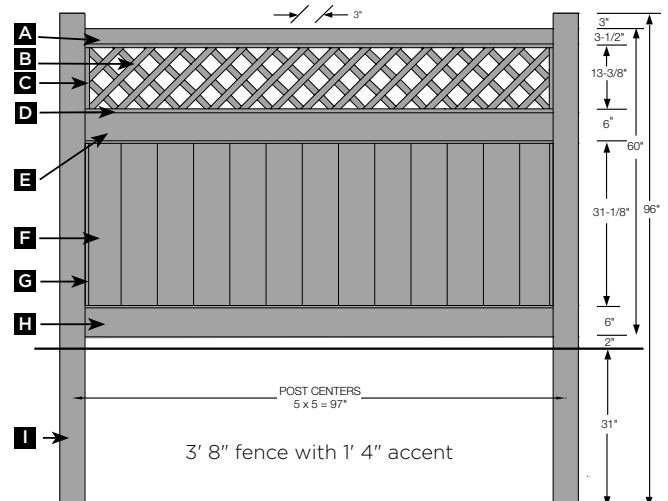

**Privacy
Chesterfield**

5 ft. High / 8 ft. Wide

Select one of the available colors
 ■ Almond ■ Clay ■ White

For colors, add color letters to item number: Almond (AL), Clay (C).

Note: Mixed color sections must be ordered as components; pricing will be higher than standard sections.

QUANTITY	PRODUCT NUMBER	DESCRIPTION
FENCE SECTIONS		
_____	206459	Chesterfield Fence Section (5 ft. x 8 ft.)

Note: Fence section includes A, B, C, D and section hardware. Post and caps sold separately.

5 IN. X 5 IN. POSTS		
_____	673315	Corner Post 5 in. x 5 in. x 96 in.
_____	673325	Line Post 5 in. x 5 in. x 96 in.
_____	673335	End Post 5 in. x 5 in. x 96 in.
_____	679096	Blank Post Heavy Wall 5 in. x 5 in. x 96 in.

POST CAPS		
_____	70493	Ball Cap 5 in. x 5 in.
_____	70416	Gothic Cap Ext 5 in. x 5 in.
_____	70418	Flat Cap Ext 5 in. x 5 in.
_____	70427	New England Cap Ext 5 in. x 5 in.

GATES (hardware ordered separately)		
_____	42723	Gate Kit (builds up to 50-1/2 in. wide gate)
_____	70027	Gate Extension Kit (builds up to 70 in. gate) gate kit must also be ordered
_____	427054	Preassembled Gate 36-1/2 in. Wide
_____	437054	Preassembled Gate 50-1/2 in. Wide
_____	447054	Preassembled Gate 64-3/4 in. Wide
_____	70095	Aluminum 5 in. x 5 in. x 94 in. Gate Post Stiffener
_____	27635	Drop Pin Kit
_____	27742	5 ft. to 6 ft. Height Gate Hardware (self-closing hinges and latch)
_____	27745	Deluxe Key Entry Nylon Gate Hardware (5 ft. and 6 ft. height fence)
_____	27752	Plus Key Entry Nylon Gate Hardware (5 ft. and 6 ft. height fence)
_____	27747	LokkLatch Magnetic Gate Hardware (5 ft. and 6 ft. height fence)
_____	27731	Standard Stainless Steel Gate Hardware Pebble Black Finish

Note: Gate kits include (2) 2-1/2 in. x 4 in. up-rights, caps and screws. Rails and pickets ordered separately.

OPTIONAL/EXTRA MATERIAL		
_____	70090	Steel Reinforcement Channel x 92 in. for 2 in. x 6 in. Rail
_____	619095	Chesterfield Deco Channeled Top Rail 2 in. x 6 in. x 95 in.
_____	614895	2 in. x 6 in. x 95 in. Deco Top/Bottom Rail with Steel
_____	60783P	Lock Rings (order 2 per rail) Qty: 24
_____	469050F	Chesterfield Fence Fill Kit 7/8 in. x 7 in. x 50-3/4 in. Tongue and Groove (13 pc)
_____	71414	2 in. EZ Set Post Brackets (pair with hardware - optional)
_____	16959	End Channel 7/8 in. x 1 in. x 59-7/8 in.

Note: End channels must be attached to posts.

A TOP RAIL PALLET QUANTITY = 84
 2" x 6" x 95" Deco rail ribbed.

Note: Clay color includes steel in top rail

B PICKETS PALLET QUANTITY = 12 Fill Kits
 Section includes 13 pickets of
 7/8" x 7" x 50-3/4"

C END CHANNEL
 SUPPLIED: 7/8" x 1" x 59-7/8"
 FIELD CUT: 7/8" x 1" x 47-7/8"

D BOTTOM RAIL PALLET QUANTITY = 84
 2" x 6" x 95" Deco rail ribbed.
 Includes steel channel.

E POST PALLET QUANTITY = 48
 5" x 5" x 96"



**MEETS
POOL
CODE**

Racks up to 10 degrees

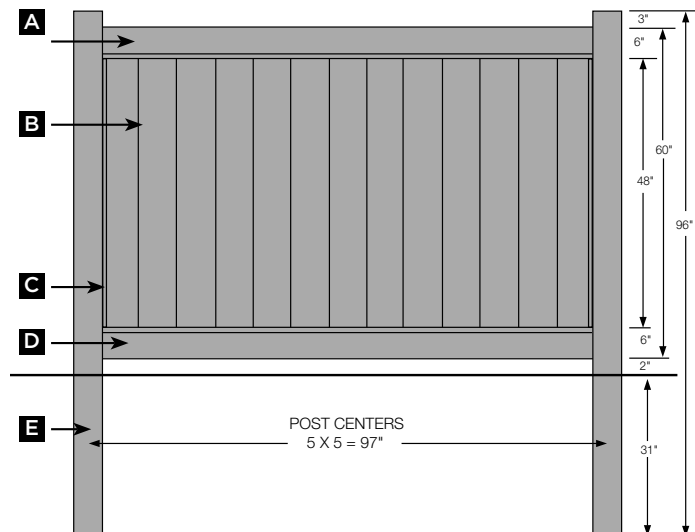

For colors, add color letters to item number: Almond (AL), Clay (C), Grey (G).

Note: Mixed color sections must be ordered as components; pricing will be higher than standard sections.

QUANTITY	PRODUCT NUMBER	DESCRIPTION
FENCE SECTIONS		
_____	206469	Chesterfield Fence Section (6 ft. x 8 ft.)

Note: Fence section includes A, B, C, D and section hardware. Post and caps sold separately.

5 IN. X 5 IN. POSTS		
_____	673415	Corner Post 5 in. x 5 in. x 107 in.
_____	673425	Line Post 5 in. x 5 in. x 107 in.
_____	71106	Aluminum 5 in. x 5 in. x 106 in. Line Post Stiffener
_____	673435	End Post 5 in. x 5 in. x 107 in.
_____	679108	Blank Post Heavy Wall 5 in. x 5 in. x 107 in.
_____	70148	Aluminum 5 in. x 5 in. x 48 in. Line Post Stiffener Kit (required for WindZone system)

POST CAPS		
_____	70493	Ball Cap 5 in. x 5 in.
_____	70416	Gothic Cap Ext 5 in. x 5 in.
_____	70418	Flat Cap Ext 5 in. x 5 in.
_____	70427	New England Cap Ext 5 in. x 5 in.

GATES (hardware ordered separately)		
_____	42724	Gate Kit (builds up to 50-1/2 in. wide gate)
_____	70027	Gate Extension Kit (builds up to 70 in. gate) gate kit must also be ordered
_____	427055	Preassembled Gate 36-1/2 in. Wide
_____	437055	Preassembled Gate 50-1/2 in. Wide
_____	447055	Preassembled Gate 64-3/4 in. Wide
_____	70106	Aluminum 5 in. x 5 in. x 106 in. Gate Post Stiffener
_____	27635	Drop Pin Kit
_____	27742	5 ft. to 6 ft. Height Gate Hardware (self-closing hinges and latch)
_____	27745	Deluxe Key Entry Nylon Gate Hardware (5 ft. and 6 ft. height fence)
_____	27752	Plus Key Entry Nylon Gate Hardware (5 ft. and 6 ft. height fence)
_____	27747	LokkLatch Magnetic Gate Hardware (5 ft. and 6 ft. height fence)
_____	27731	Standard Stainless Steel Gate Hardware Pebble Black Finish

Note: Gate kits include (2) 2-1/2 in. x 4 in. up-rights, caps and screws. Rails and pickets ordered separately.

OPTIONAL/EXTRA MATERIAL		
_____	70090	Steel Reinforcement Channel x 92 in. for 2 in. x 6 in. Rail
_____	619095	Chesterfield Deco Channeled Top Rail 2 in. x 6 in. x 95 in.
_____	614895	2 in. x 6 in. x 95 in. Deco Top/Bottom Rail with Steel
_____	60783P	Lock Rings (order 2 per rail) Qty: 24
_____	469062F	Chesterfield Fence Fill Kit 7/8 in. x 7 in. x 62-3/4 in. Tongue and Groove (13 pc)
_____	71414	2 in. EZ Set Post Brackets (pair with hardware - optional)
_____	16959	End Channel 7/8 in. x 1 in. x 59-7/8 in.

Note: End channels must be attached to posts.

- A TOP RAIL** PALLET QUANTITY = 84
2" x 6" x 95" Deco rail ribbed.
Note: Clay color includes steel in top rail.
- B PICKETS** PALLET QUANTITY = 12 Fill Kits
Section includes 13 pickets of
7/8" x 7" x 62-3/4" .
- C END CHANNEL**
7/8" x 1" x 59-7/8"
- D BOTTOM RAIL** PALLET QUANTITY = 84
2" x 6" x 95" Deco rail ribbed.
Includes steel channel.
- E POST** PALLET QUANTITY = 48
5" x 5" x 107"

Racks up to 10 degrees



**FEATURING
WINDZONE-
TECHNOLOGY**



**MEETS
POOL
CODE**

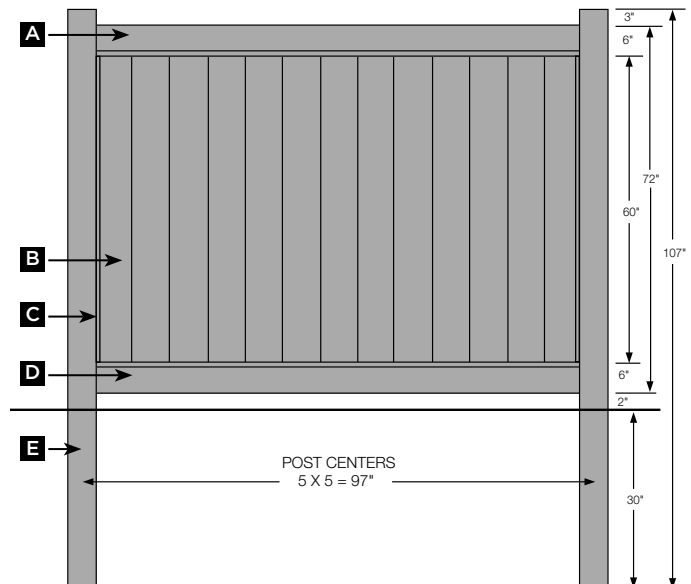

**Privacy
Chesterfield S Curve**

**6 ft. High / 8 ft. Wide / 24
in. Drop**

Select one of the available colors
 Almond White

For Almond, add (AL) to item number.

Note: Mixed color sections must be ordered as components; pricing will be higher than standard sections.

QUANTITY	PRODUCT NUMBER	DESCRIPTION
FENCE SECTION		
_____	207319	Chesterfield Fence Section with S Curve (6 ft. x 8 ft. with 24 in. drop)
<i>Note: Fence section includes A, B, C, D and section hardware. Post and caps sold separately. Curved rail pre-cut for 8 ft. panel; pickets must be field cut. Post for S Curve is standard Chesterfield post.</i>		
5 IN. X 5 IN. POSTS - 6 FT. END		
_____	673415	Corner Post 5 in. x 5 in. x 107 in.
_____	673425	Line Post 5 in. x 5 in. x 107 in.
_____	71106	Aluminum 5 in. x 5 in. x 106 in. Line Post Stiffener
_____	673435	End Post 5 in. x 5 in. x 107 in.
_____	679108	Blank Post Heavy Wall 5 in. x 5 in. x 107 in.
5 IN. X 5 IN. POSTS - 4 FT. END		
_____	642715	Corner Post 5 in. x 5 in. x 84 in.
_____	642725	Line Post 5 in. x 5 in. x 84 in.
_____	642735	End Post 5 in. x 5 in. x 84 in.
_____	539084	Blank Post 5 in. x 5 in. x 84 in.
POST CAPS		
_____	70493	Ball Cap 5 in. x 5 in.
_____	70416	Gothic Cap Ext 5 in. x 5 in.
_____	70418	Flat Cap Ext 5 in. x 5 in.
_____	70427	New England Cap Ext 5 in. x 5 in.
OPTIONAL/EXTRA MATERIAL		
_____	70090	Steel Reinforcement Channel x 92 in. for 2 in. x 6 in. Rail
_____	619321	2 in. x 6 in. x 108 in. Deco S Curve Top Rail
_____	614895	2 in. x 6 in. x 95 in. Deco Top/Bottom Rail with Steel
_____	60783P	Lock Rings (order 2 per rail) Qty: 24
_____	469062F	Chesterfield Fence Fill Kit 7/8 in. x 7 in. x 62-3/4 in. Tongue and Groove (13 pc)
_____	71414	2 in. EZ Set Post Brackets (pair with hardware - optional)
_____	16959	End Channel 7/8 in. x 1 in. x 59-7/8 in.

Note: End channels must be attached to posts. Pickets require field cutting.

- A TOP RAIL**
2" x 6" x 108" S Curve
Deco rail ribbed.
- B PICKETS**
Section includes 13 pickets of
7/8" x 7" x 62-3/4"
- C END CHANNEL**
7/8" x 1" x 59-7/8"
- D BOTTOM RAIL**
2" x 6" x 95" Deco rail ribbed.
Includes steel channel.
- E POST**
5" x 5" x 107"
- F POST**
5" x 5" x 84"

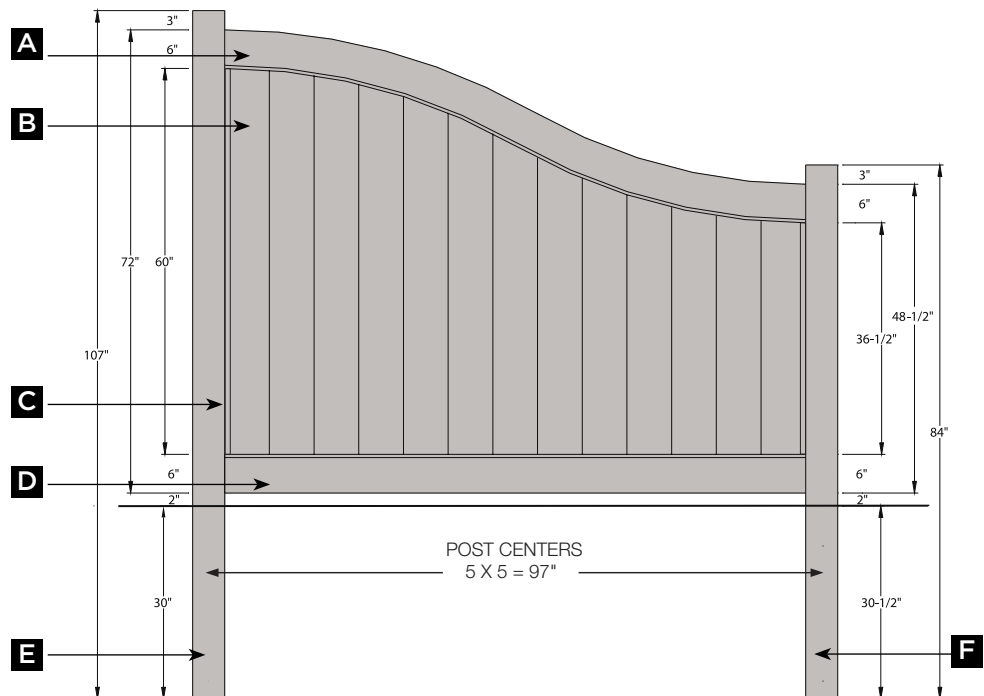

**Privacy
Chesterfield Swoop**

**6 ft. High / 8 ft. Wide / 24
in. Drop**

Select one of the available colors
 Almond White

For Almond, add (AL) to item number.

Note: Mixed color sections must be ordered as components; pricing will be higher than standard sections.

QUANTITY	PRODUCT NUMBER	DESCRIPTION
FENCE SECTION		
_____	207309	Chesterfield Fence Section with Swoop Top Rail (6 ft. x 8 ft. with 24 in. drop)
<i>Note: Fence section includes A, B, C, D and section hardware. Post and caps sold separately. Curved rail pre-cut for 8 ft. panel; pickets must be field cut. Swoop posts are routed special; see top view illustrations.</i>		
5 IN. X 5 IN. POSTS - 6 FT. END		
_____	673801L	Transition Left Corner Post 5 in. x 5 in. x 107 in.
_____	673801R	Transition Right Corner Post 5 in. x 5 in. x 107 in.
_____	673802	Transition Line Post 5 in. x 5 in. x 107 in.
_____	673803	End Post for Swoop 5 in. x 5 in. x 107 in.
_____	679108	Blank Post Heavy Wall 5 in. x 5 in. x 107 in.
5 IN. X 5 IN. POSTS - 4 FT. END		
_____	642715	Corner Post 5 in. x 5 in. x 84 in.
_____	642725	Line Post 5 in. x 5 in. x 84 in.
_____	642735	End Post 5 in. x 5 in. x 84 in.
_____	539084	Blank Post 5 in. x 5 in. x 84 in.
POST CAPS		
_____	70493	Ball Cap 5 in. x 5 in.
_____	70416	Gothic Cap Ext 5 in. x 5 in.
_____	70417	Flat Cap Int 5 in. x 5 in.
_____	70418	Flat Cap Ext 5 in. x 5 in.
_____	70427	New England Cap Ext 5 in. x 5 in.
OPTIONAL/EXTRA MATERIAL		
_____	70090	Steel Reinforcement Channel x 92 in. for 2 in. x 6 in. Rail
_____	619301	Chesterfield 2 in. x 6 in. x 108 in. Deco Swoop Top Rail
_____	614895	2 in. x 6 in. x 95 in. Deco Top/Bottom Rail with Steel
_____	60783P	Lock Rings (order 2 per rail) Qty: 24
_____	469062F	Chesterfield Fence Fill Kit 7/8 in. x 7 in. x 62-3/4 in. Tongue and Groove (13 pc)
_____	71414	2 in. EZ Set Post Brackets (pair with hardware - optional)
_____	16959	End Channel 7/8 in. x 1 in. x 59-7/8 in.

Note: End channels must be attached to posts. Pickets require field cutting.

- A TOP RAIL**
2" x 6" x 108"
Deco rail ribbed.
- B PICKETS**
Section includes 13 pickets of
7/8" x 7" x 62-3/4"
- C END CHANNEL**
SUPPLIED: 7/8" x 1" x 59-7/8"
FIELD CUT: 7/8" x 1" x 58-7/8"
- D BOTTOM RAIL**
2" x 6" x 95" Deco rail ribbed.
Includes steel channel.
- E POST**
5" x 5" x 107"
- F POST**
5" x 5" x 84"

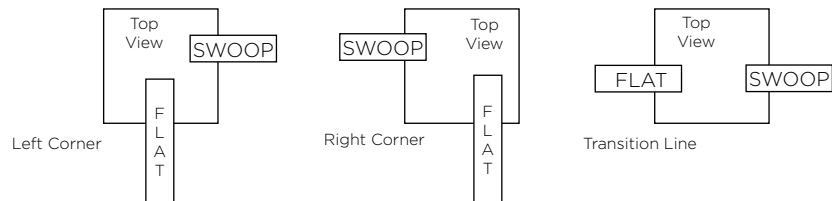
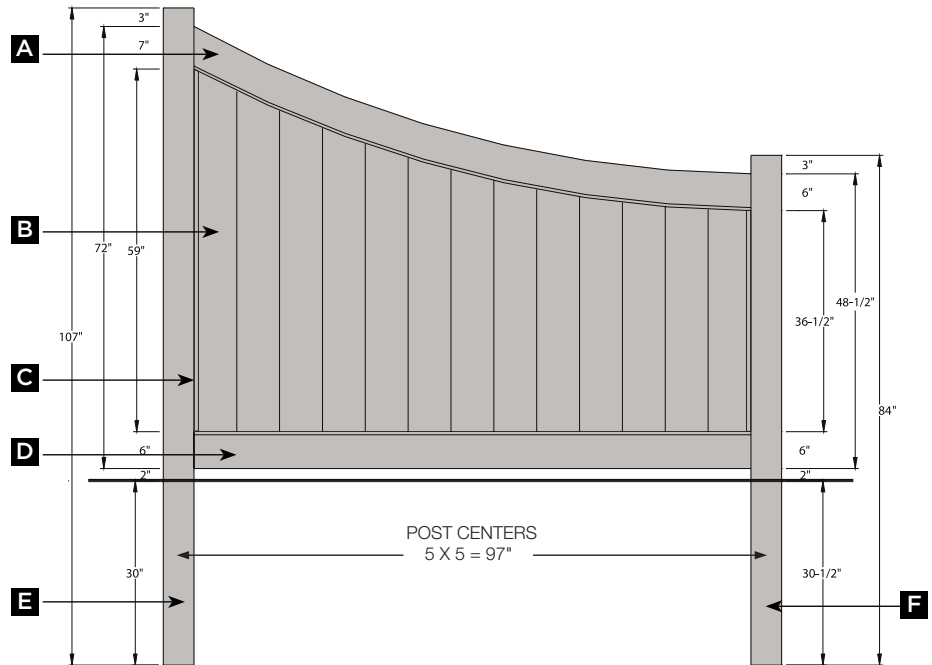

QUANTITY	PRODUCT NUMBER	DESCRIPTION
_____	42727	Convex Victorian Preassembled Gate 50-1/2 in. Wide
_____	437060	Concave Victorian Preassembled Gate 50-1/2 in. Wide
_____	27742	5 ft. to 6 ft. Height Gate Hardware (self-closing hinges and latch)
_____	27745	Deluxe Key Entry Nylon Gate Hardware (5 ft. and 6 ft. height fence)
_____	27752	Plus Key Entry Nylon Gate Hardware (5 ft. and 6 ft. height fence)
_____	27747	LokkLatch Magnetic Gate Hardware (5 ft. and 6 ft. height fence)
_____	27731	Standard Stainless Steel Gate Hardware Pebble Black Finish
_____	70106	Aluminum 5 in. x 5 in. x 106 in. Gate Post Stiffener
_____	27635	Drop Pin Kit

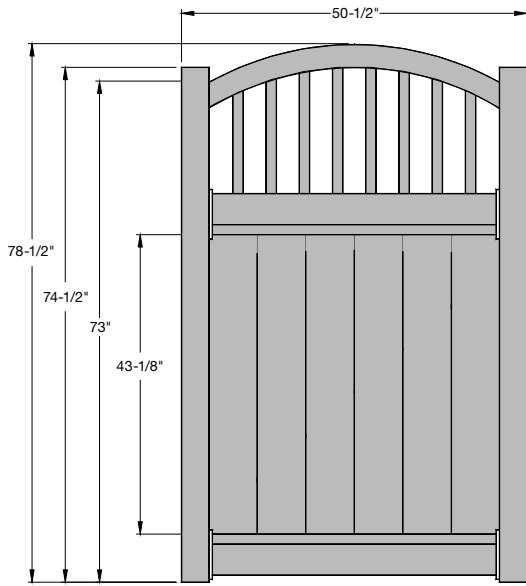

Chesterfield Convex

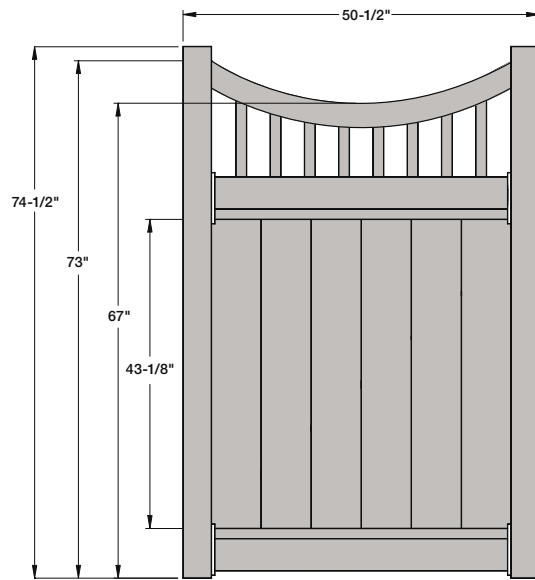

Chesterfield Concave

**Privacy
Chesterfield with Lattice
Accent**

6 ft. High / 8 ft. Wide

Select one of the available colors
 Almond White

For Almond, add (AL) to item number.

Note: Mixed color sections must be ordered as components; pricing will be higher than standard sections.

QUANTITY	PRODUCT NUMBER	DESCRIPTION
FENCE SECTIONS		
_____	22056	Chesterfield Fence Section with Lattice Accent (6 ft. x 8 ft.)
<i>Note: Fence section includes A, B, C, D, E, F, G, H and section hardware. Post and caps sold separately.</i>		
5 IN. X 5 IN. POSTS		
_____	68021	Corner Post 5 in. x 5 in. x 107 in.
_____	68022	Line Post 5 in. x 5 in. x 107 in.
_____	71106	Aluminum 5 in. x 5 in. x 106 in. Line Post Stiffener
_____	68023	End Post 5 in. x 5 in. x 107 in.
_____	679108	Blank Post Heavy Wall 5 in. x 5 in. x 107 in.
_____	70148	Aluminum 5 in. x 5 in. x 48 in. Line Post Stiffener Kit (required for WindZone system)
POST CAPS		
_____	70493	Ball Cap 5 in. x 5 in.
_____	70416	Gothic Cap Ext 5 in. x 5 in.
_____	70418	Flat Cap Ext 5 in. x 5 in.
_____	70427	New England Cap Ext 5 in. x 5 in.
GATES (hardware ordered separately)		
_____	42725	Gate Kit with Accent (builds up to 50-1/2 in. wide gate)
_____	70027	Gate Extension Kit (builds up to 70 in. gate) gate kit must also be ordered
_____	427056	Preassembled Gate with Lattice Accent 36-1/2 in. Wide
_____	437056	Preassembled Gate with Lattice Accent 50-1/2 in. Wide
_____	447056	Preassembled Gate with Lattice Accent 64-3/4 in. Wide
_____	70106	Aluminum 5 in. x 5 in. x 106 in. Gate Post Stiffener
_____	27635	Drop Pin Kit
_____	27742	5 ft. to 6 ft. Height Gate Hardware (self-closing hinges and latch)
_____	27745	Deluxe Key Entry Nylon Gate Hardware (5 ft. and 6 ft. height fence)
_____	27752	Plus Key Entry Nylon Gate Hardware (5 ft. and 6 ft. height fence)
_____	27747	LokkLatch Magnetic Gate Hardware (5 ft. and 6 ft. height fence)
_____	27731	Standard Stainless Steel Gate Hardware Pebble Black Finish
<i>Note: Gate kits include (2) 2-1/2 in. x 4 in. up-rights, caps and screws. Rails and pickets ordered separately.</i>		
OPTIONAL/EXTRA MATERIAL		
_____	70090	Steel Reinforcement Channel x 92 in. for 2 in. x 6 in. Rail
_____	619095	Chesterfield Deco Channeled Top Rail 2 in. x 6 in. x 95 in.
_____	614895	2 in. x 6 in. x 95 in. Deco Top/Bottom Rail with Steel
_____	290095	2 in. x 3-1/2 in. x 95 in. Accent Rail
_____	60783P	Lock Rings (order 2 per rail) Qty: 24
_____	469046F	Chesterfield Fence Fill Kit 7/8 in. x 7 in. x 45-3/4 in. Tongue and Groove (13 pc)
_____	444129	13 in. x 91-1/2 in. Lattice Insert (diagonal)
_____	17991	Horizontal Channel for Lattice 5/8 in. x 1 in. x 90-3/4 in.
_____	17913	Vertical Channel for Lattice 5/8 in. x 1 in. x 13-1/8 in.
_____	71414	2 in. EZ Set Post Brackets (pair with hardware - optional)
_____	16959	End Channel 7/8 in. x 1 in. x 59-7/8 in.

Note: End channels must be attached to posts.

- A TOP ACCENT RAIL**
 PALLET QUANTITY = 120
 2" x 3-1/2" x 95"
- B LATTICE PANEL**
 1 piece of 13" x 91-1/2"
 1-1/4" x 1/4" strips
- C HORIZONTAL CHANNEL**
 2 Pieces of
 5/8" x 1" x 90 -3/4"
- D VERTICAL CHANNEL**
 2 Pieces of
 5/8" x 1" x 13-1/8"
- E TOP RAIL**
 PALLET QUANTITY = 84
 2" x 6" x 95"
 Deco rail ribbed.
- F PICKETS**
 PALLET QUANTITY =
 12 Fill Kits
 Section includes 13 pickets of
 7/8" x 7" x 45-3/4"

- G END CHANNEL**
 Supplied: 7/8" x 1" x 59-7/8"
 Field cut: 7/8" x 1" x 43"
- H BOTTOM RAIL**
 PALLET QUANTITY = 84
 2" x 6" x 95" Deco rail ribbed.
 Includes steel channel.
- I POST**
 PALLET QUANTITY = 48
 5" x 5" x 107"

Racks up to 10 degrees*
***Accents will reduce the degree of rack.**

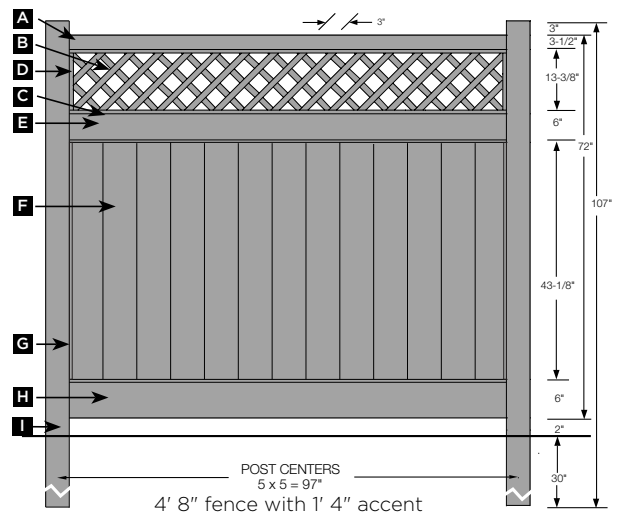

**FEATURING
WINDZONE-
TECHNOLOGY**



**MEETS
POOL
CODE**

**Privacy
Chesterfield with Huntington
Accent**

6 ft. High / 8 ft. Wide

Select one of the available colors
■ Almond ■ White

For Almond, add (AL) to item number.

Note: Mixed color sections must be ordered as components; pricing will be higher than standard sections.

QUANTITY	PRODUCT NUMBER	DESCRIPTION
FENCE SECTIONS		
_____	22096	Chesterfield Fence Section with Huntington Accent (6 ft. x 8 ft.)

Note: Fence section includes A, B, C, D, E, F and section hardware. Post and caps sold separately.

5 IN. X 5 IN. POSTS		
_____	68051	Huntington Accent Corner Post 5 in. x 5 in. x 107 in.
_____	68052	Huntington Accent Line Post 5 in. x 5 in. x 107 in.
_____	71106	Aluminum 5 in. x 5 in. x 106 in. Line Post Stiffener
_____	68053	Huntington Accent End Post 5 in. x 5 in. x 107 in.
_____	679108	Blank Post Heavy Wall 5 in. x 5 in. x 107 in.

POST CAPS		
_____	70493	Ball Cap 5 in. x 5 in.
_____	70416	Gothic Cap Ext 5 in. x 5 in.
_____	70418	Flat Cap Ext 5 in. x 5 in.
_____	70427	New England Cap Ext 5 in. x 5 in.

GATES (hardware ordered separately)		
_____	42726	Huntington Accent Gate Kit (builds up to 50-1/2 in. wide gate)
_____	70027	Gate Extension Kit (builds up to 70 in. gate) gate kit must also be ordered
_____	427059	Preassembled Gate with Huntington Accent 36-1/2 in. Wide
_____	437059	Preassembled Gate with Huntington Accent 50-1/2 in. Wide
_____	447059	Preassembled Gate with Huntington Accent 64-3/4 in. Wide
_____	70106	Aluminum 5 in. x 5 in. x 106 in. Gate Post Stiffener
_____	27635	Drop Pin Kit
_____	27742	5 ft. to 6 ft. Height Gate Hardware (self-closing hinges and latch)
_____	27745	Deluxe Key Entry Nylon Gate Hardware (5 ft. and 6 ft. height fence)
_____	27752	Plus Key Entry Nylon Gate Hardware (5 ft. and 6 ft. height fence)
_____	27747	LokkLatch Magnetic Gate Hardware (5 ft. and 6 ft. height fence)
_____	27731	Standard Stainless Steel Gate Hardware Pebble Black Finish

Note: Gate kits include (2) 2-1/2 in. x 4 in. up-rights, caps and screws. Rails and pickets ordered separately.

OPTIONAL/EXTRA MATERIAL		
_____	70090	Steel Reinforcement Channel x 92 in. for 2 in. x 6 in. Rail
_____	61495	Chesterfield Huntington 2 in. x 6 in. x 95 in. Deco Top Rail Routed
_____	614895	2 in. x 6 in. x 95 in. Deco Top/Bottom Rail with Steel
_____	290564	2 in. x 3-1/2 in. x 95 in. Routed Mid Rail
_____	60783P	Lock Rings (order 2 per rail) Qty: 24
_____	469046F	Chesterfield Fence Fill Kit 7/8 in. x 7 in. x 45-3/4 in. Tongue and Groove (13 pc)
_____	388017	Accent Picket 1-1/2 in. x 1-1/2 in. x 16-1/2 in. with Pointed Cap
_____	388020	Chesterfield Huntington Accent Picket 1-1/2 in. x 1-1/2 in. x 19-1/2 in. with Pointed Cap
_____	71414	2 in. EZ Set Post Brackets (pair with hardware - optional)
_____	16959	End Channel 7/8 in. x 1 in. x 59-7/8 in.

Note: End channels must be attached to posts.

- A TOP ACCENT RAIL** PALLET QUANTITY = 120
2" x 3-1/2" x 95"
- B PICKETS**
8 pieces of 1-1/2" x 1-1/2" x 19-1/2"
(field cut to achieve desired scallop)
21 pieces of 1-1/2" x 1-1/2" x 16-1/2"
- C TOP RAIL** PALLET QUANTITY = 84
2" x 6" x 95" Deco rail ribbed.
- D PICKETS** PALLET QUANTITY = 12 Fill Kits
Section includes 13 pickets of 7/8" x 7" x 45-3/4"
- E END CHANNEL**
SUPPLIED: 7/8" x 1" x 59-7/8"
FIELD CUT: 7/8" x 1" x 43"
- F BOTTOM RAIL** PALLET QUANTITY = 84
2" x 6" x 95" Deco rail ribbed. Includes steel channel.
- G POST** PALLET QUANTITY = 48
5" x 5" x 107"

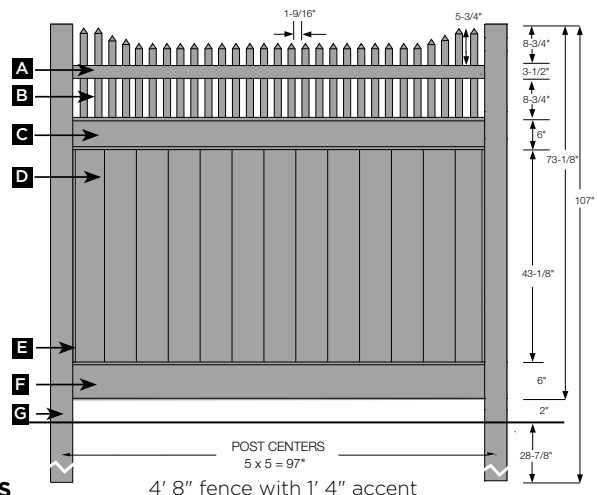

**MEETS
POOL
CODE**

Racks up to 10 degrees*
***Accents will reduce the degree of rack.**

**Privacy
Chesterfield with Victorian
Accent**

6 ft. High / 8 ft. Wide

Select one of the available colors
 Almond White

For Almond, add (AL) to item number.

Note: Mixed color sections must be ordered as components; pricing will be higher than standard sections.

QUANTITY	PRODUCT NUMBER	DESCRIPTION
FENCE SECTIONS		
_____	22076	Chesterfield Fence Section with Victorian Accent (6 ft. x 8 ft.)
<i>Note: Fence section includes A, B, C, D, E, F and section hardware. Post and caps sold separately.</i>		
5 IN. X 5 IN. POSTS		
_____	68021	Corner Post 5 in. x 5 in. x 107 in.
_____	68022	Line Post 5 in. x 5 in. x 107 in.
_____	71106	Aluminum 5 in. x 5 in. x 106 in. Line Post Stiffener
_____	68023	End Post 5 in. x 5 in. x 107 in.
_____	679108	Blank Post Heavy Wall 5 in. x 5 in. x 107 in.
POST CAPS		
_____	70493	Ball Cap 5 in. x 5 in.
_____	70416	Gothic Cap Ext 5 in. x 5 in.
_____	70418	Flat Cap Ext 5 in. x 5 in.
_____	70427	New England Cap Ext 5 in. x 5 in.
GATES (hardware ordered separately)		
_____	42725	Gate Kit with Accent (builds up to 50-1/2 in. wide gate)
_____	70027	Gate Extension Kit (builds up to 70 in. gate) gate kit must also be ordered
_____	427057	Preassembled Gate with Victorian Accent 36-1/2 in. Wide
_____	437057	Preassembled Gate with Victorian Accent 50-1/2 in. Wide
_____	447057	Preassembled Gate with Victorian Accent 64-3/4 in. Wide
_____	70106	Aluminum 5 in. x 5 in. x 106 in. Gate Post Stiffener
_____	27635	Drop Pin Kit
_____	27742	5 ft. to 6 ft. Height Gate Hardware (self-closing hinges and latch)
_____	27745	Deluxe Key Entry Nylon Gate Hardware (5 ft. and 6 ft. height fence)
_____	27752	Plus Key Entry Nylon Gate Hardware (5 ft. and 6 ft. height fence)
_____	27747	LokkLatch Magnetic Gate Hardware (5 ft. and 6 ft. height fence)
_____	27731	Standard Stainless Steel Gate Hardware Pebble Black Finish
<i>Note: Gate kits include (2) 2-1/2 in. x 4 in. up-rights, caps and screws. Rails and pickets ordered separately.</i>		
OPTIONAL/EXTRA MATERIAL		
_____	70090	Steel Reinforcement Channel x 92 in. for 2 in. x 6 in. Rail
_____	61997	2 in. x 6 in. x 95 in. Deco Top Rail - Victorian Accent
_____	614895	2 in. x 6 in. x 95 in. Deco Top/Bottom Rail with Steel
_____	60783P	Lock Rings (order 2 per rail) Qty: 24
_____	469046F	Chesterfield Fence Fill Kit 7/8 in. x 7 in. x 45-3/4 in. Tongue and Groove (13 pc)
_____	319017	7/8 in. x 1-1/2 in. x 17-3/4 in. Accent Picket
_____	290565	2 in. x 3-1/2 in. x 95 in. Routed Rail Victorian Accent
_____	71414	2 in. EZ Set Post Brackets (pair with hardware - optional)
_____	16959	End Channel 7/8 in. x 1 in. x 59-7/8 in.

Note: End channels must be attached to posts.

- A TOP ACCENT RAIL** PALLET QUANTITY = 120
2" x 3-1/2" x 95"
- B ACCENT PICKET**
17 pieces of 7/8" x 1-1/2" x 17-3/4"
- C TOP RAIL** PALLET QUANTITY = 84
2" x 6" x 95" Deco rail ribbed.
- D PICKETS** PALLET QUANTITY = 12 Fill Kits
7/8" x 7" x 45-3/4" Section includes 13 pickets.
- E END CHANNEL**
SUPPLIED: 7/8" x 1" x 59-7/8"
FIELD CUT: 7/8" x 1" x 43"
- F BOTTOM RAIL** PALLET QUANTITY = 84
2" x 6" x 95" Deco rail ribbed.
Includes steel channel
- G POST** PALLET QUANTITY = 48
5" x 5" x 107"



**MEETS
POOL
CODE**

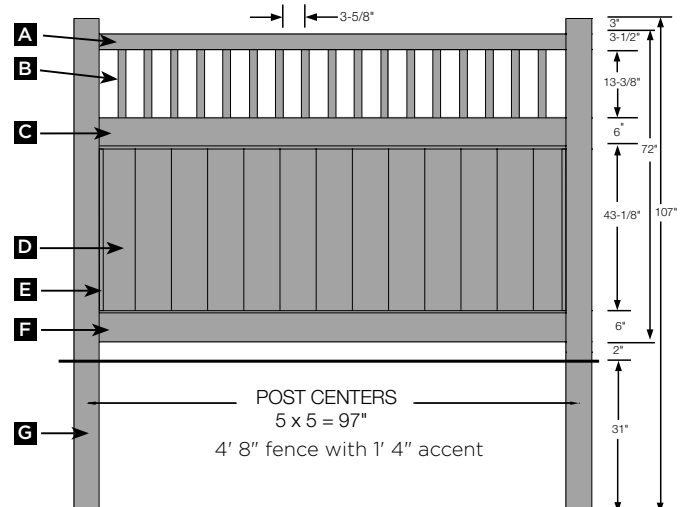

Racks up to 10 degrees*

***Accents will reduce the degree of rack.**

**Privacy
Chesterfield with
Westminster Accent**

6 ft. High / 8 ft. Wide

Select one of the available colors
■ White

QUANTITY	PRODUCT NUMBER	DESCRIPTION
----------	----------------	-------------

FENCE SECTIONS

_____	22006	Chesterfield Fence Section with Westminster Accent (6 ft. x 8 ft.)
-------	-------	--

Note: Fence section includes A, B, C, D, E, F, G, H and section hardware. Post and caps sold separately.

5 IN. X 5 IN. POSTS

_____	68021	Corner Post 5 in. x 5 in. x 107 in.
_____	68022	Line Post 5 in. x 5 in. x 107 in.
_____	71106	Aluminum 5 in. x 5 in. x 106 in. Line Post Stiffener
_____	68023	End Post 5 in. x 5 in. x 107 in.
_____	679108	Blank Post Heavy Wall 5 in. x 5 in. x 107 in.

POST CAPS

_____	70493	Ball Cap 5 in. x 5 in.
_____	70416	Gothic Cap Ext 5 in. x 5 in.
_____	70418	Flat Cap Ext 5 in. x 5 in.
_____	70427	New England Cap Ext 5 in. x 5 in.

GATES (hardware ordered separately)

_____	42725	Gate Kit with Accent (builds up to 50-1/2 in. wide gate)
_____	70027	Gate Extension Kit (builds up to 70 in. gate) gate kit must also be ordered
_____	427058	Preassembled Gate with Westminster Accent 36-1/2 in. Wide
_____	437058	Preassembled Gate with Westminster Accent 50-1/2 in. Wide
_____	447058	Preassembled Gate with Westminster Accent 64-3/4 in. Wide
_____	70106	Aluminum 5 in. x 5 in. x 106 in. Gate Post Stiffener
_____	27635	Drop Pin Kit
_____	27742	5 ft. to 6 ft. Height Gate Hardware (self-closing hinges and latch)
_____	27745	Deluxe Key Entry Nylon Gate Hardware (5 ft. and 6 ft. height fence)
_____	27752	Plus Key Entry Nylon Gate Hardware (5 ft. and 6 ft. height fence)
_____	27747	LokkLatch Magnetic Gate Hardware (5 ft. and 6 ft. height fence)
_____	27731	Standard Stainless Steel Gate Hardware Pebble Black Finish

Note: Gate kits include (2) 2-1/2 in. x 4 in. up-rights, caps and screws. Rails and pickets ordered separately.

OPTIONAL/EXTRA MATERIAL

_____	70090	Steel Reinforcement Channel x 92 in. for 2 in. x 6 in. Rail
_____	619095	Chesterfield Deco Channeled Top Rail 2 in. x 6 in. x 95 in.
_____	614895	2 in. x 6 in. x 95 in. Deco Top/Bottom Rail with Steel
_____	290095	2 in. x 3-1/2 in. x 95 in. Accent Rail
_____	60783P	Lock Rings (order 2 per rail) Qty: 24
_____	469046F	Chesterfield Fence Fill Kit 7/8 in. x 7 in. x 45-3/4 in. Tongue and Groove (13 pc)
_____	446138	Chesterfield Westminster 13 in. x 91-1/2 in. Lattice Insert (square)
_____	17913	Vertical Channel for Lattice 5/8 in. x 1 in. x 13-1/8 in.
_____	17991	Horizontal Channel for Lattice 5/8 in. x 1 in. x 90-3/4 in.
_____	71414	2 in. EZ Set Post Brackets (pair with hardware - optional)
_____	16959	End Channel 7/8 in. x 1 in. x 59-7/8 in.

Note: End channels must be attached to posts.

A TOP ACCENT RAIL
PALLET QUANTITY = 120
2" x 3-1/2" x 95"

B LATTICE PANEL
1 piece of 13" x 91-1/2"
1-1/4" x 1/4" Strips.

C HORIZONTAL CHANNEL
2 pieces 5/8" x 1" x 90-3/4"

D VERTICAL CHANNEL
2 pieces 5/8" x 1" x 13-1/8"

E TOP RAIL
PALLET QUANTITY = 84
2" x 6" x 95" Deco rail ribbed.

F PICKETS
PALLET QUANTITY =
12 Fill Kits
Section includes 13 pickets of
7/8" x 7" x 45-3/4"

G END CHANNEL
SUPPLIED: 7/8" x 1" x 59-7/8"
FIELD CUT: 7/8" x 1" x 43"

H BOTTOM RAIL
PALLET QUANTITY = 84
2" x 6" x 95" Deco rail ribbed.
Includes steel channel

I POST
PALLET QUANTITY = 48
5" x 5" x 107"

Racks up to 10 degrees*
***Accents will reduce the degree of rack.**



**MEETS
POOL
CODE**

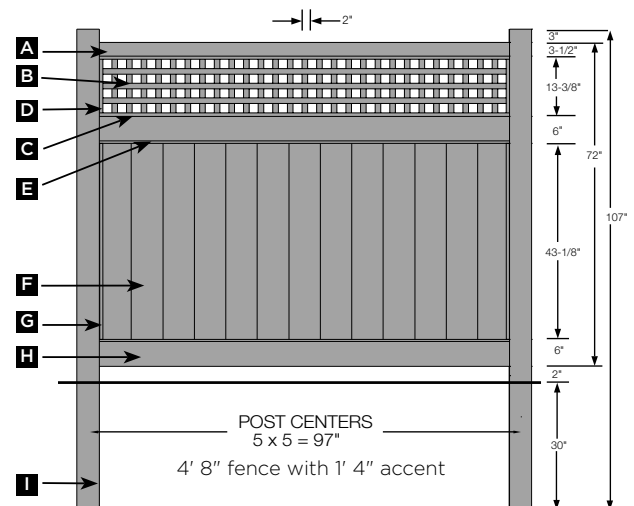

**Privacy
Chesterfield with CertaGrain
Texture**

4 ft. High / 8 ft. Wide

Select one of the available colors

- Almond ■ Arbor Blend ■ Arctic Blend
- Brazilian Blend ■ Clay
- Frontier Blend ■ Sierra Blend
- Timber Blend ■ Weathered Blend
- White

For colors, add color letters to item number: Almond (AL), Arbor Blend (AR4), Arctic Blend (AC4), Brazilian Blend (BR4), Clay (C), Frontier Blend (FB4), Sierra Blend (SB4), Timber Blend (TB4), Weathered Blend (WB4).

Note: Mixed color sections must be ordered as components; pricing will be higher than standard sections.

QUANTITY	PRODUCT NUMBER	DESCRIPTION
FENCE SECTIONS		
_____	30644	Chesterfield Fence Section with CertaGrain Texture (4 ft. x 8 ft.)
<i>Note: Fence section includes A, B, C, D and section hardware. Post and caps sold separately.</i>		
5 IN. X 5 IN. POSTS		
_____	75301	CertaGrain Corner Post 5 in. x 5 in. x 84 in.
_____	75302	CertaGrain Line Post 5 in. x 5 in. x 84 in.
_____	75303	CertaGrain End Post 5 in. x 5 in. x 84 in.
_____	759084	CertaGrain Blank Post 5 in. x 5 in. x 84 in.
POST CAPS		
_____	70444	CertaGrain Flat Top Cap Ext 5 in. x 5 in.
_____	70459	Textured New England Cap 5 in. x 5 in.
GATES (hardware ordered separately)		
_____	31841	CertaGrain Textured Gate Kit (builds up to 50-1/2 in. wide gate)
_____	70027	Gate Extension Kit (builds up to 70 in. gate) gate kit must also be ordered
_____	328041	CertaGrain Preassembled Gate 50-1/2 in. Wide
_____	70095	Aluminum 5 in. x 5 in. x 94 in. Gate Post Stiffener
_____	27635	Drop Pin Kit
_____	27742	5 ft. to 6 ft. Height Gate Hardware (self-closing hinges and latch)
_____	27745	Deluxe Key Entry Nylon Gate Hardware (5 ft. and 6 ft. height fence)
_____	27752	Plus Key Entry Nylon Gate Hardware (5 ft. and 6 ft. height fence)
_____	27747	LokkLatch Magnetic Gate Hardware (5 ft. and 6 ft. height fence)
_____	27731	Standard Stainless Steel Gate Hardware Pebble Black Finish
<i>Note: Gate kits include (2) 2-1/2 in. x 4 in. up-rights, caps and screws. Rails and pickets ordered separately.</i>		
OPTIONAL/EXTRA MATERIAL		
_____	70090	Steel Reinforcement Channel x 92 in. for 2 in. x 6 in. Rail
_____	749095	Chesterfield CertaGrain Top Rail 2 in. x 6 in. x 95 in.
_____	744095	CertaGrain 2 in. x 6 in. x 95 in. Top/Bottom Rail with Steel
_____	60783P	Lock Rings (order 2 per rail) Qty: 24
_____	769040F	Chesterfield CertaGrain 7/8 in. x 7 in. x 39-1/4 in. Tongue and Groove Fill Kit (13 pc)
_____	71414	2 in. EZ Set Post Brackets (pair with hardware - optional)
_____	26948	End Channel 7/8 in. x 1 in. x 47-7/8 in.

Note: End channels must be attached to posts.

- A TOP RAIL PALLET QUANTITY = 84**
2" x 6" x 95" rail ribbed.
Note: Arbor Blend, Arctic Blend, Brazilian Blend, Clay, Frontier Blend, Sierra Blend, Timber Blend and Weathered Blend colors include steel in top rail.
- B PICKETS PALLET QUANTITY = 12 Fill Kits**
Section includes 13 pickets of 7/8" x 7" x 39-1/4"
- C END CHANNEL**
SUPPLIED: 7/8" x 1" x 47-7/8"
FIELD CUT: 7/8" x 1" x 36-3/8"
- D BOTTOM RAIL PALLET QUANTITY = 84**
2" x 6" x 95" rail ribbed.
Includes steel channel.
- E POST PALLET QUANTITY = 48**
5" x 5" x 84"



Racks up to 10 degrees

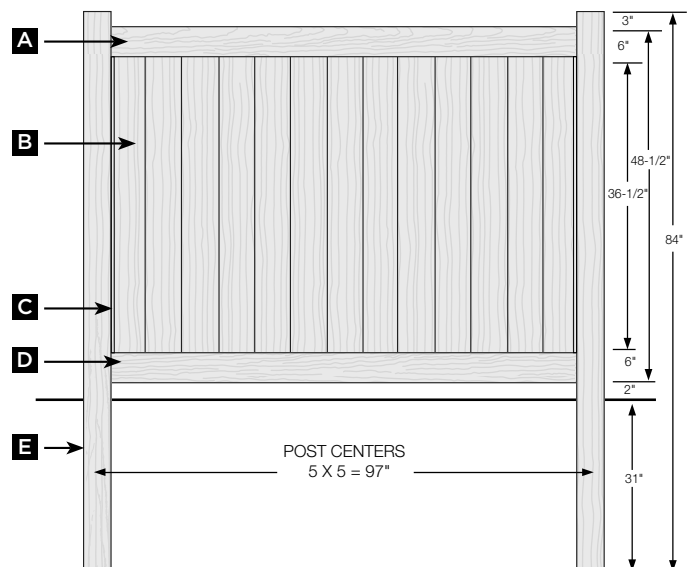

**Privacy
Chesterfield with CertaGrain
Texture**

5 ft. High / 8 ft. Wide

Select one of the available colors

- Almond ■ Arbor Blend ■ Arctic Blend
- Brazilian Blend ■ Clay
- Frontier Blend ■ Sierra Blend
- Timber Blend ■ Weathered Blend
- White

For colors, add color letters to item number: Almond (AL), Arbor Blend (AR4), Arctic Blend (AC4), Brazilian Blend (BR4), Clay (C), Frontier Blend (FB4), Sierra Blend (SB4), Timber Blend (TB4), Weathered Blend (WB4).
Note: Mixed color sections must be ordered as components; pricing will be higher than standard sections.

QUANTITY	PRODUCT NUMBER	DESCRIPTION
FENCE SECTIONS		
_____	30645	Chesterfield Fence Section with CertaGrain Texture (5 ft. x 8 ft.)
<i>Note: Fence section includes A, B, C, D and section hardware. Post and caps sold separately.</i>		
5 IN. X 5 IN. POSTS		
_____	75201	CertaGrain Corner Post 5 in. x 5 in. x 96 in.
_____	75202	CertaGrain Line Post 5 in. x 5 in. x 96 in.
_____	75203	CertaGrain End Post 5 in. x 5 in. x 96 in.
_____	759096	CertaGrain Blank Post Heavy Wall 5 in. x 5 in. x 96 in.
POST CAPS		
_____	70444	CertaGrain Flat Top Cap Ext 5 in. x 5 in.
_____	70459	Textured New England Cap 5 in. x 5 in.
GATES (hardware ordered separately)		
_____	31851	CertaGrain Textured Gate Kit (builds up to 50-1/2 in. wide gate)
_____	70027	Gate Extension Kit (builds up to 70 in. gate) gate kit must also be ordered
_____	318051	CertaGrain Preassembled Gate 36-1/2 in. Wide
_____	328051	CertaGrain Preassembled Gate 50-1/2 in. Wide
_____	338051	CertaGrain Preassembled Gate 64-3/4 in. Wide
_____	70095	Aluminum 5 in. x 5 in. x 94 in. Gate Post Stiffener
_____	27635	Drop Pin Kit
_____	27742	5 ft. to 6 ft. Height Gate Hardware (self-closing hinges and latch)
_____	27745	Deluxe Key Entry Nylon Gate Hardware (5 ft. and 6 ft. height fence)
_____	27752	Plus Key Entry Nylon Gate Hardware (5 ft. and 6 ft. height fence)
_____	27747	LokkLatch Magnetic Gate Hardware (5 ft. and 6 ft. height fence)
_____	27731	Standard Stainless Steel Gate Hardware Pebble Black Finish
<i>Note: Gate kits include (2) 2-1/2 in. x 4 in. up-rights, caps and screws. Rails and pickets ordered separately.</i>		
OPTIONAL/EXTRA MATERIAL		
_____	70090	Steel Reinforcement Channel x 92 in. for 2 in. x 6 in. Rail
_____	749095	Chesterfield CertaGrain Top Rail 2 in. x 6 in. x 95 in.
_____	744095	CertaGrain 2 in. x 6 in. x 95 in. Top/Bottom Rail with Steel
_____	60783P	Lock Rings (order 2 per rail) Qty: 24
_____	769050F	Chesterfield CertaGrain 7/8 in. x 7 in. x 50-3/4 in. Tongue and Groove Fill Kit (13 pc)
_____	71414	2 in. EZ Set Post Brackets (pair with hardware - optional)
_____	26948	End Channel 7/8 in. x 1 in. x 47-7/8 in.

Note: End channels must be attached to posts.

- A TOP RAIL** PALLET QUANTITY = 84
2" x 6" x 95" rail ribbed.
Note: Arbor Blend, Arctic Blend, Brazilian Blend, Clay, Frontier Blend, Sierra Blend, Timber Blend and Weathered Blend colors include steel in top rail.
- B PICKETS** PALLET QUANTITY = 12 Fill Kits
Section includes 13 pickets 7/8" x 7" x 50-3/4"
- C END CHANNEL**
7/8" x 1" x 47-7/8"
- D BOTTOM RAIL**
PALLET QUANTITY = 84
2" x 6" x 95" rail ribbed.
Includes steel channel.
- E POST** PALLET QUANTITY = 48
5" x 5" x 96"



**MEETS
POOL
CODE**

Racks up to 10 degrees

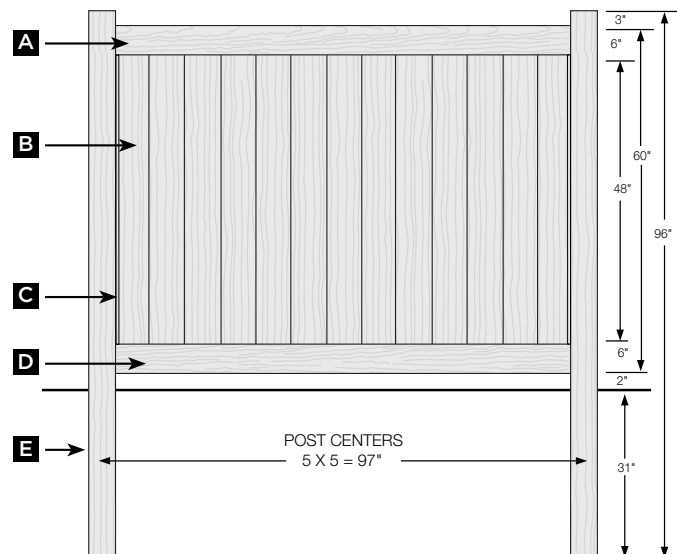

**Privacy
Chesterfield with CertaGrain
Texture**

6 ft. High / 8 ft. Wide

Select one of the available colors

- Almond ■ Arbor Blend ■ Arctic Blend
- Brazilian Blend ■ Clay
- Frontier Blend ■ Sierra Blend
- Timber Blend ■ Weathered Blend
- White

For colors, add color letters to item number: Almond (AL), Arbor Blend (AR4), Arctic Blend (AC4), Brazilian Blend (BR4), Clay (C), Frontier Blend (FB4), Sierra Blend (SB4), Timber Blend (TB4), Weathered Blend (WB4).
Note: Mixed color sections must be ordered as components; pricing will be higher than standard sections.

QUANTITY	PRODUCT NUMBER	DESCRIPTION
FENCE SECTIONS		
_____	30646	Chesterfield Fence Section with CertaGrain Texture (6 ft. x 8 ft.)
<i>Note: Fence section includes A, B, C, D and section hardware. Post and caps sold separately.</i>		
5 IN. X 5 IN. POSTS		
_____	75101	CertaGrain Corner Post 5 in. x 5 in. x 107 in.
_____	75102	CertaGrain Line Post 5 in. x 5 in. x 107 in.
_____	71106	Aluminum 5 in. x 5 in. x 106 in. Line Post Stiffener
_____	75103	CertaGrain End Post 5 in. x 5 in. x 107 in.
_____	759108	CertaGrain Blank Post Heavy Wall 5 in. x 5 in. x 107 in.
_____	70148	Aluminum 5 in. x 5 in. x 48 in. Line Post Stiffener Kit (required for WindZone system)
POST CAPS		
_____	70444	CertaGrain Flat Top Cap Ext 5 in. x 5 in.
_____	70459	Textured New England Cap 5 in. x 5 in.
GATES (hardware ordered separately)		
_____	31861	CertaGrain Textured Gate Kit (builds up to 50-1/2 in. wide gate)
_____	70027	Gate Extension Kit (builds up to 70 in. gate) gate kit must also be ordered
_____	318061	CertaGrain Preassembled Gate 36-1/2 in. Wide
_____	328061	CertaGrain Preassembled Gate 50-1/2 in. Wide
_____	338061	CertaGrain Preassembled Gate 64-3/4 in. Wide
_____	70106	Aluminum 5 in. x 5 in. x 106 in. Gate Post Stiffener
_____	27635	Drop Pin Kit
_____	27742	5 ft. to 6 ft. Height Gate Hardware (self-closing hinges and latch)
_____	27745	Deluxe Key Entry Nylon Gate Hardware (5 ft. and 6 ft. height fence)
_____	27752	Plus Key Entry Nylon Gate Hardware (5 ft. and 6 ft. height fence)
_____	27747	LokkLatch Magnetic Gate Hardware (5 ft. and 6 ft. height fence)
_____	27731	Standard Stainless Steel Gate Hardware Pebble Black Finish
<i>Note: Gate kits include (2) 2-1/2 in. x 4 in. up-rights, caps and screws. Rails and pickets ordered separately.</i>		
OPTIONAL/EXTRA MATERIAL		
_____	70090	Steel Reinforcement Channel x 92 in. for 2 in. x 6 in. Rail
_____	749095	Chesterfield CertaGrain Top Rail 2 in. x 6 in. x 95 in.
_____	744095	CertaGrain 2 in. x 6 in. x 95 in. Top/Bottom Rail with Steel
_____	60783P	Lock Rings (order 2 per rail) Qty: 24
_____	769062F	Chesterfield CertaGrain 7/8 in. x 7 in. x 62-3/4 in. Tongue and Groove Fill Kit (13 pc)
_____	71414	2 in. EZ Set Post Brackets (pair with hardware - optional)
_____	26960	CertaGrain Textured End Channel 7/8 in. x 1 in. x 59-7/8 in.

Note: End channels must be attached to posts.

A TOP RAIL PALLET QUANTITY = 84

2" x 6" x 95" rail ribbed.
Note: Arbor Blend, Arctic Blend, Brazilian Blend, Clay, Frontier Blend, Sierra Blend, Timber Blend and Weathered Blend colors include steel in top rail.

B PICKETS PALLET QUANTITY = 12 Fill Kits

Section includes 13 pickets of 7/8" x 7" x 62-3/4"

C END CHANNEL

7/8" x 1" x 59-7/8"

D BOTTOM RAIL

PALLET QUANTITY = 84
2" x 6" x 95" rail ribbed.
Includes steel channel.

E POST PALLET QUANTITY = 48

5" x 5" x 107"



**FEATURING
WINDZONE-
TECHNOLOGY**



**MEETS
POOL
CODE**

Racks up to 10 degrees

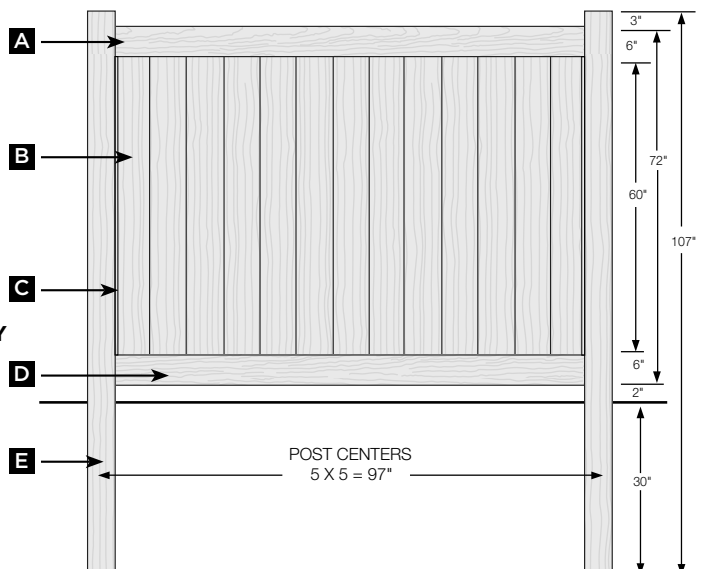

**Privacy
Chesterfield with CertaGrain
Texture - Concave**

6 ft. High / 8 ft. Wide

Select one of the available colors
 ■ Arctic Blend ■ Brazilian Blend
 ■ Sierra Blend ■ Weathered Blend

For colors, add color letters to item number: Arctic Blend (AC4), Brazilian Blend (BR4), Sierra Blend (SB4), Weathered Blend (WB4).

Note: Mixed color sections must be ordered as components; pricing will be higher than standard sections.

QUANTITY	PRODUCT NUMBER	DESCRIPTION
FENCE SECTIONS		
_____	30666	Chesterfield Fence Section with CertaGrain Texture Concave/Swoop Top Rail
<i>Note: Fence section includes A, B, C, D and section hardware. Post and caps sold separately.</i>		
5 IN. X 5 IN. POSTS		
_____	75811	CertaGrain Concave/Convex Corner Post 5 in. x 5 in. x 107 in.
_____	75812	CertaGrain Concave/Convex Line Post 5 in. x 5 in. x 107 in.
_____	71106	Aluminum 5 in. x 5 in. x 106 in. Line Post Stiffener
_____	75813	CertaGrain Concave/Convex End Post 5 in. x 5 in. x 107 in.
_____	759108	CertaGrain Blank Post Heavy Wall 5 in. x 5 in. x 107 in.
POST CAPS		
_____	70444	CertaGrain Flat Top Cap Ext 5 in. x 5 in.
_____	70459	Textured New England Cap 5 in. x 5 in.
OPTIONAL/EXTRA MATERIAL		
_____	70090	Steel Reinforcement Channel x 92 in. for 2 in. x 6 in. Rail
_____	749301	CertaGrain 2 in. x 6 in. Swoop Top Rail
_____	744095	CertaGrain 2 in. x 6 in. x 95 in. Top/Bottom Rail with Steel
_____	60783P	Lock Rings (order 2 per rail) Qty: 24
_____	769062F	Chesterfield CertaGrain 7/8 in. x 7 in. x 62-3/4 in. Tongue and Groove Fill Kit (13 pc)
_____	71414	2 in. EZ Set Post Brackets (pair with hardware - optional)
_____	26960	CertaGrain Textured End Channel 7/8 in. x 1 in. x 59-7/8 in.

Note: End channels must be attached to posts. Pickets require field cutting.

- A TOP RAIL** PALLET QUANTITY = 84
2" x 6" x 97-1/2" rail ribbed.
Note: Arctic Blend, Brazilian Blend, Sierra Blend and Weathered Blend colors include aluminum in top rail.
- B PICKETS** PALLET QUANTITY = 12 Fill Kits
Section includes 13 pickets of 7/8" x 7" x 62-3/4"
- C END CHANNEL**
7/8" x 1" x 59-7/8"
- D BOTTOM RAIL**
PALLET QUANTITY = 84
2" x 6" x 95" rail ribbed.
Includes steel channel.
- E POST** PALLET QUANTITY = 48
5" x 5" x 107"



**MEETS
POOL
CODE**

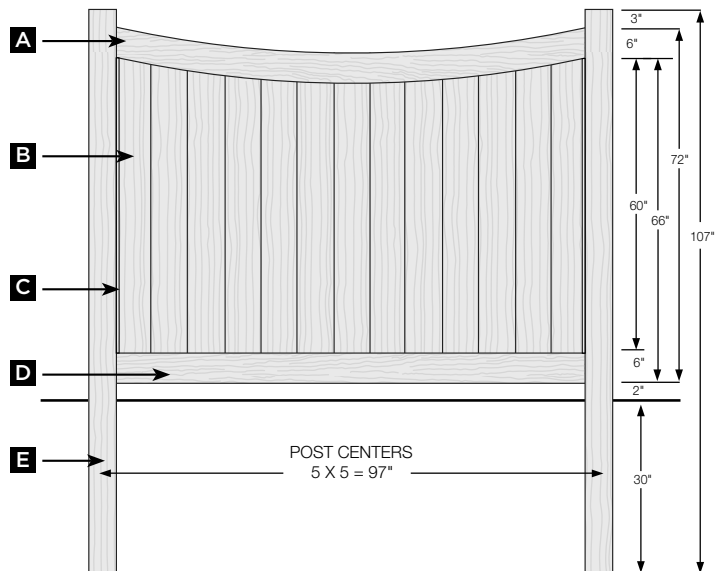

**Privacy
Chesterfield with CertaGrain
Texture - Convex**

5-1/2-6 ft. High / 8 ft. Wide

Select one of the available colors

- Arctic Blend ■ Brazilian Blend
- Sierra Blend ■ Weathered Blend

For colors, add color letters to item number: Arctic Blend (AC4), Brazilian Blend (BR4), Sierra Blend (SB4), Weathered Blend (WB4).

Note: Mixed color sections must be ordered as components; pricing will be higher than standard sections.

QUANTITY	PRODUCT NUMBER	DESCRIPTION
FENCE SECTIONS		
_____	30657	Chesterfield Fence Section Convex with CertaGrain Texture (5-1/2 ft. x 8 ft.)
<i>Note: Fence section includes A, B, C, D and section hardware. Post and caps sold separately.</i>		
5 IN. x 5 IN. POSTS		
_____	75821	CertaGrain Convex Corner Post 5 in. x 5 in. x 107 in.
_____	75822	CertaGrain Convex Line Post 5 in. x 5 in. x 107 in.
_____	71106	Aluminum 5 in. x 5 in. x 106 in. Line Post Stiffener
_____	75823	CertaGrain Convex End Post 5 in. x 5 in. x 107 in.
_____	759108	CertaGrain Blank Post Heavy Wall 5 in. x 5 in. x 107 in.
POST CAPS		
_____	70444	CertaGrain Flat Top Cap Ext 5 in. x 5 in.
_____	70459	Textured New England Cap 5 in. x 5 in.
OPTIONAL/EXTRA MATERIAL		
_____	70090	Steel Reinforcement Channel x 92 in. for 2 in. x 6 in. Rail
_____	749311	Chesterfield CertaGrain Convex Top Rail 2 in. x 6 in. x 96-1/2 in.
_____	744095	CertaGrain 2 in. x 6 in. x 95 in. Top/Bottom Rail with Steel
_____	60783P	Lock Rings (order 2 per rail) Qty: 24
_____	769062F	Chesterfield CertaGrain 7/8 in. x 7 in. x 62-3/4 in. Tongue and Groove Fill Kit (13 pc)
_____	71414	2 in. EZ Set Post Brackets (pair with hardware - optional)
_____	26960	CertaGrain Textured End Channel 7/8 in. x 1 in. x 59-7/8 in.

Note: End channels must be attached to posts. Pickets require field cutting.

- A TOP RAIL** PALLET QUANTITY = 84
2" x 6" x 96-1/2" convex rail ribbed.
Note: Arctic Blend, Brazilian Blend, Sierra Blend and Weathered Blend colors include aluminum in top rail.
- B PICKETS** PALLET QUANTITY = 12 Fill Kits
Section includes 13 pickets of 7/8" x 7" x 62-3/4"
- C END CHANNEL**
7/8" x 1" x 59-7/8"
- D BOTTOM RAIL**
PALLET QUANTITY = 84
2" x 6" x 95" rail ribbed.
Includes steel channel.
- E POST** PALLET QUANTITY = 48
5" x 5" x 107"



**MEETS
POOL
CODE**

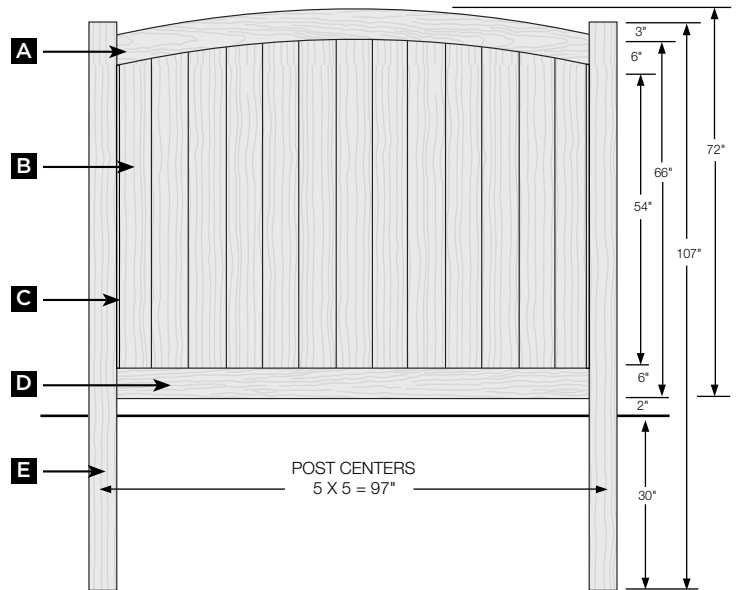

**Privacy
Chesterfield with CertaGrain
Texture - Convex**

6-6-1/2 ft. High / 8 ft. Wide

Select one of the available colors
 ■ Arctic Blend ■ Brazilian Blend
 ■ Sierra Blend ■ Weathered Blend

For colors, add color letters to item number: Arctic Blend (AC4), Brazilian Blend (BR4), Sierra Blend (SB4), Weathered Blend (WB4).

Note: Mixed color sections must be ordered as components; pricing will be higher than standard sections.

QUANTITY	PRODUCT NUMBER	DESCRIPTION
FENCE SECTIONS		
_____	30676	Chesterfield Fence Section Convex with CertaGrain Texture (6 ft. x 8 ft.)
<i>Note: Fence Section includes A, B, C, D and section hardware. Post and caps sold separately.</i>		
5 IN. x 5 IN. POSTS		
_____	75811	CertaGrain Concave/Convex Corner Post 5 in. x 5 in. x 107 in.
_____	75812	CertaGrain Concave/Convex Line Post 5 in. x 5 in. x 107 in.
_____	71106	Aluminum 5 in. x 5 in. x 106 in. Line Post Stiffener
_____	75813	CertaGrain Concave/Convex End Post 5 in. x 5 in. x 107 in.
_____	759108	CertaGrain Blank Post Heavy Wall 5 in. x 5 in. x 107 in.
POST CAPS		
_____	70444	CertaGrain Flat Top Cap Ext 5 in. x 5 in.
_____	70459	Textured New England Cap 5 in. x 5 in.
OPTIONAL/EXTRA MATERIAL		
_____	70090	Steel Reinforcement Channel x 92 in. for 2 in. x 6 in. Rail
_____	749311	Chesterfield CertaGrain Convex Top Rail 2 in. x 6 in. x 96-1/2 in.
_____	744095	CertaGrain 2 in. x 6 in. x 95 in. Top/Bottom Rail with Steel
_____	60783P	Lock Rings (order 2 per rail) Qty: 24
_____	769069F	Chesterfield CertaGrain 7/8 in. x 7 in. x 69 in. Tongue and Groove Fill Kit (13 pc)
_____	71414	2 in. EZ Set Post Brackets (pair with hardware - optional)
_____	26960	CertaGrain Textured End Channel 7/8 in. x 1 in. x 59-7/8 in.

Note: End channels must be attached to posts. Pickets require field cutting.

- A TOP RAIL** PALLET QUANTITY = 84
2" x 6" x 96-1/2" convex rail ribbed.
Note: Arctic Blend, Brazilian Blend, Sierra Blend and Weathered Blend colors include aluminum in top rail.
- B PICKETS** PALLET QUANTITY = 12 Fill Kits
Section includes 13 pickets of 7/8" x 7" x 69"
- C END CHANNEL**
7/8" x 1" x 59-7/8"
- D BOTTOM RAIL**
PALLET QUANTITY = 84
2" x 6" x 95" rail ribbed.
Includes steel channel.
- E POST** PALLET QUANTITY = 48
5" x 5" x 107"



**MEETS
POOL
CODE**

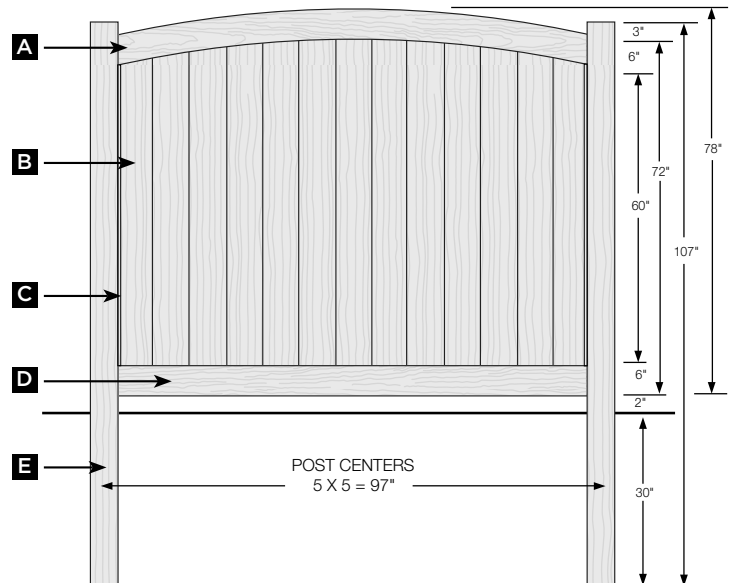

**Privacy
Chesterfield with CertaGrain
Texture S Curve**

**6 ft. High / 8 ft. Wide / 24
in. Drop**

Select one of the available colors
 ■ Arctic Blend ■ Brazilian Blend
 ■ Sierra Blend ■ Weathered Blend

For colors, add color letters to item number: Arctic Blend (AC4), Brazilian Blend (BR4), Sierra Blend (SB4), Weathered Blend (WB4).

Note: Mixed color sections must be ordered as components; pricing will be higher than standard sections.

QUANTITY	PRODUCT NUMBER	DESCRIPTION
FENCE SECTION		
_____	30696	Chesterfield Fence Section with CertaGrain Texture S-Curve (6 ft. x 8 ft. with 24 in. drop)
<i>Note: Fence section includes A, B, C, D and section hardware. Post and caps sold separately. Curved rail pre-cut for 8 ft. panel; pickets must be field cut. Post for S curve is standard Chesterfield post.</i>		
5 IN. x 5 IN. POSTS - 6 FT. END		
_____	75101	CertaGrain Corner Post 5 in. x 5 in. x 107 in.
_____	75102	CertaGrain Line Post 5 in. x 5 in. x 107 in.
_____	71106	Aluminum 5 in. x 5 in. x 106 in. Line Post Stiffener
_____	75103	CertaGrain End Post 5 in. x 5 in. x 107 in.
_____	759108	CertaGrain Blank Post Heavy Wall 5 in. x 5 in. x 107 in.
5 IN. x 5 IN. POSTS - 4 FT. END		
_____	75301	CertaGrain Corner Post 5 in. x 5 in. x 84 in.
_____	75302	CertaGrain Line Post 5 in. x 5 in. x 84 in.
_____	75303	CertaGrain End Post 5 in. x 5 in. x 84 in.
_____	759084	CertaGrain Blank Post 5 in. x 5 in. x 84 in.
POST CAPS		
_____	70444	CertaGrain Flat Top Cap Ext 5 in. x 5 in.
_____	70459	Textured New England Cap 5 in. x 5 in.
OPTIONAL/EXTRA MATERIAL		
_____	70090	Steel Reinforcement Channel x 92 in. for 2 in. x 6 in. Rail
_____	749321	2 in. x 6 in. CertaGrain S-Curve Top Rail
_____	744095	CertaGrain 2 in. x 6 in. x 95 in. Top/Bottom Rail with Steel
_____	60783P	Lock Rings (order 2 per rail) Qty: 24
_____	769062F	Chesterfield CertaGrain 7/8 in. x 7 in. x 62-3/4 in. Tongue and Groove Fill Kit (13 pc)
_____	71414	2 in. EZ Set Post Brackets (pair with hardware - optional)
_____	26960	CertaGrain Textured End Channel 7/8 in. x 1 in. x 59-7/8 in.

Note: End channels must be attached to posts. Pickets require field cutting.

- A TOP RAIL**
2" x 6" S Curve Rail ribbed.
Note: Arctic Blend, Brazilian Blend, Sierra Blend and Weathered Blend colors include aluminum in top rail.
- B PICKETS**
Section includes 13 pickets of 7/8" x 7" x 62-3/4"
- C END CHANNEL**
7/8" x 1" x 59-7/8"
- D BOTTOM RAIL**
2" x 6" x 95" Rail ribbed.
Includes steel channel.
- E POST**
5" x 5" x 107"
- F POST**
5" x 5" x 84"

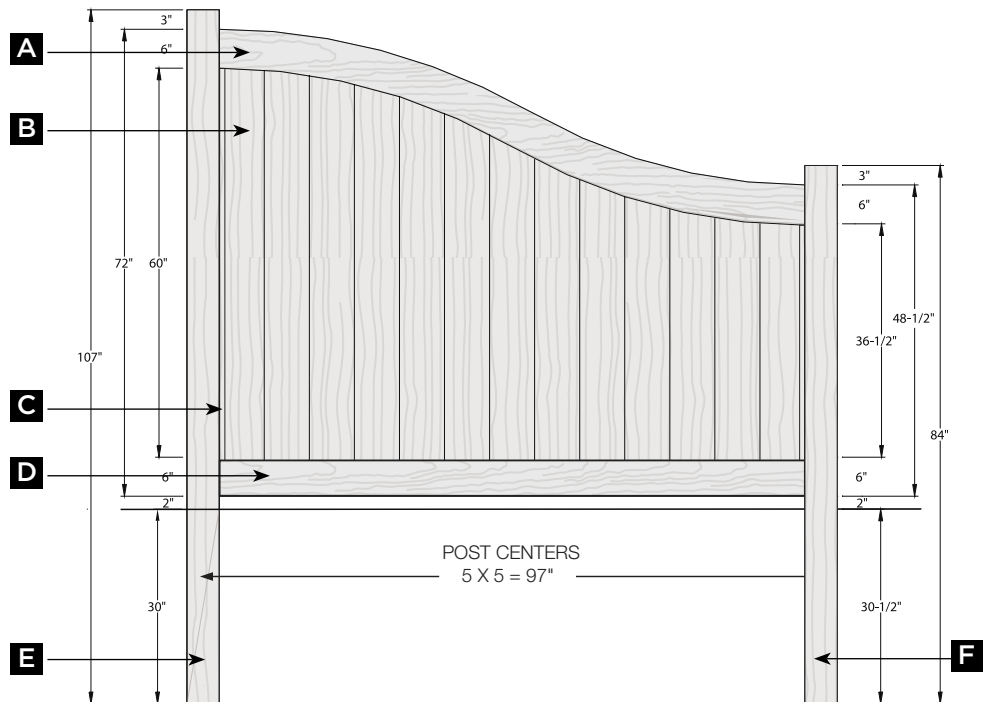

**Privacy
Chesterfield with CertaGrain
Texture Swoop**

**6 ft. High / 8 ft. Wide / 24
in. Drop**

Select one of the available colors
 ■ Arctic Blend ■ Brazilian Blend
 ■ Sierra Blend ■ Weathered Blend

For colors, add color letters to item number. Arctic Blend (AC4), Brazilian Blend (BR4), Sierra Blend (SB4), Weathered Blend (WB4)

Note: Mixed color sections must be ordered as components; pricing will be higher than standard sections.

QUANTITY	PRODUCT NUMBER	DESCRIPTION
FENCE SECTION		
_____	30666	Chesterfield Fence Section with CertaGrain Texture Concave/Swoop Top Rail
<i>Note: Fence Section includes A, B, C, D and section hardware. Post and caps sold separately. Curved rail pre cut for 8 ft. panel. Pickets must be field cut. Swoop Posts are routed special; see top view illustrations.</i>		
5 IN. x 5 IN. POSTS - 6 FT. END		
_____	753801L	CertaGrain Transition Left Corner Post 5 in. x 5 in. x 107 in.
_____	753801R	CertaGrain Transition Right Corner Post 5 in. x 5 in. x 107 in.
_____	753802	CertaGrain Transition Line Post 5 in. x 5 in. x 107 in.
_____	753803	CertaGrain End Post for Swoop 5 in. x 5 in. x 107 in.
_____	759108	CertaGrain Blank Post Heavy Wall 5 in. x 5 in. x 107 in.
5 IN. x 5 IN. POSTS - 4 FT. END		
_____	75301	CertaGrain Corner Post 5 in. x 5 in. x 84 in.
_____	75302	CertaGrain Line Post 5 in. x 5 in. x 84 in.
_____	75303	CertaGrain End Post 5 in. x 5 in. x 84 in.
_____	759084	CertaGrain Blank Post 5 in. x 5 in. x 84 in.
POST CAPS		
_____	70444	CertaGrain Flat Top Cap Ext 5 in. x 5 in.
_____	70459	Textured New England Cap 5 in. x 5 in.
OPTIONAL/EXTRA MATERIAL		
_____	70090	Steel Reinforcement Channel x 92 in. for 2 in. x 6 in. Rail
_____	749301	CertaGrain 2 in. x 6 in. Swoop Top Rail
_____	744095	CertaGrain 2 in. x 6 in. x 95 in. Top/Bottom Rail with Steel
_____	60783P	Lock Rings (order 2 per rail) Qty: 24
_____	769062F	Chesterfield CertaGrain 7/8 in. x 7 in. x 62-3/4 in. Tongue and Groove Fill Kit (13 pc)
_____	71414	2 in. EZ Set Post Brackets (pair with hardware - optional)
_____	26960	CertaGrain Textured End Channel 7/8 in. x 1 in. x 59-7/8 in.

Note: End channels must be attached to posts. Pickets require field cutting.

- A TOP RAIL**
2" x 6" Swoop Rail ribbed.
Note: Arctic Blend, Brazilian Blend, Sierra Blend and Weathered Blend colors include aluminum in top rail.
- B PICKETS**
Section includes 13 pickets
7/8" x 7" x 62-3/4"
- C END CHANNEL**
SUPPLIED: 7/8" x 1" x 59-7/8"
FIELD CUT: 7/8" x 1" x 58-7/8"
- D BOTTOM RAIL**
2" x 6" x 95" Rail ribbed.
Includes steel channel.
- E POST**
5" x 5" x 107"
- F POST**
5" x 5" x 84"

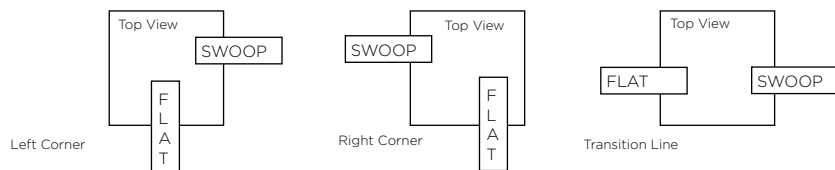
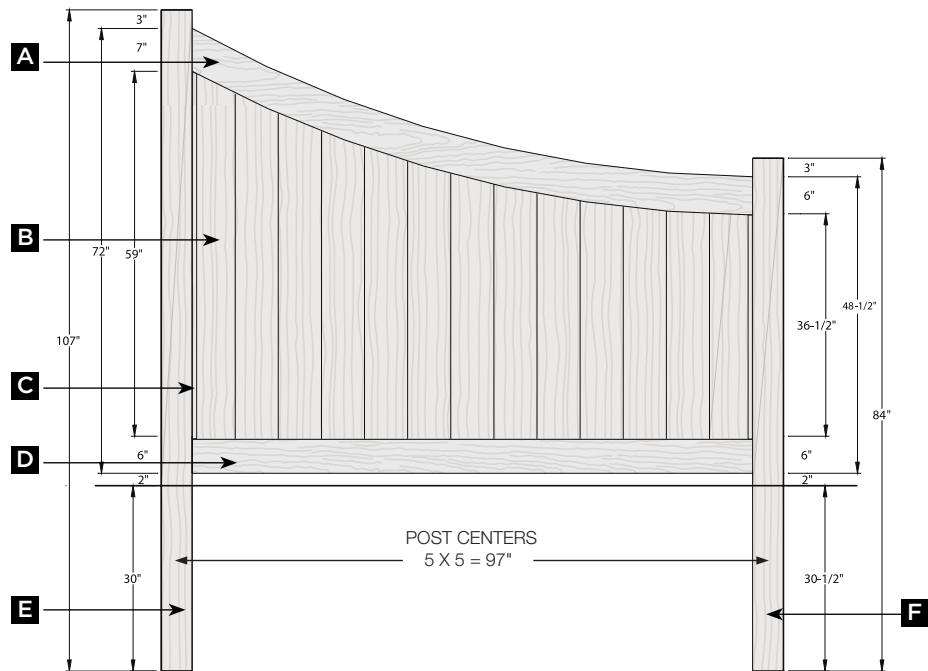

**Privacy
Chesterfield with CertaGrain
Texture - Gates**

Select one of the available colors
 ■ Arctic Blend ■ Brazilian Blend
 ■ Sierra Blend ■ Weathered Blend

For colors, add color letters to item number: Arctic Blend (AC4), Brazilian Blend (BR4), Sierra Blend (SB4), Weathered Blend (WB4).

Note: Mixed color sections must be ordered as components; pricing will be higher than standard sections.

QUANTITY	PRODUCT NUMBER	DESCRIPTION
_____	437088	CertaGrain Convex Victorian Preassembled Gate 50-1/2 in. Wide
_____	437087	CertaGrain Concave Victorian Preassembled Gate 50-1/2 in. Wide
_____	27742	5 ft. to 6 ft. Height Gate Hardware (self-closing hinges and latch)
_____	27745	Deluxe Key Entry Nylon Gate Hardware (5 ft. and 6 ft. height fence)
_____	27747	LokkLatch Magnetic Gate Hardware (5 ft. and 6 ft. height fence)
_____	27731	Standard Stainless Steel Gate Hardware Pebble Black Finish
_____	70106	Aluminum 5 in. x 5 in. x 106 in. Gate Post Stiffener
_____	27635	Drop Pin Kit

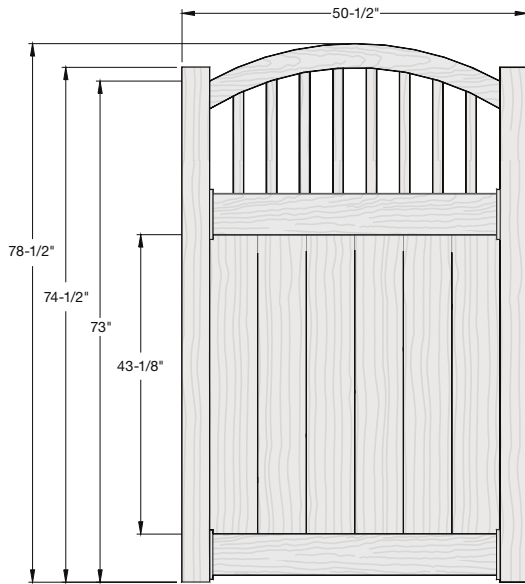

Chesterfield Convex

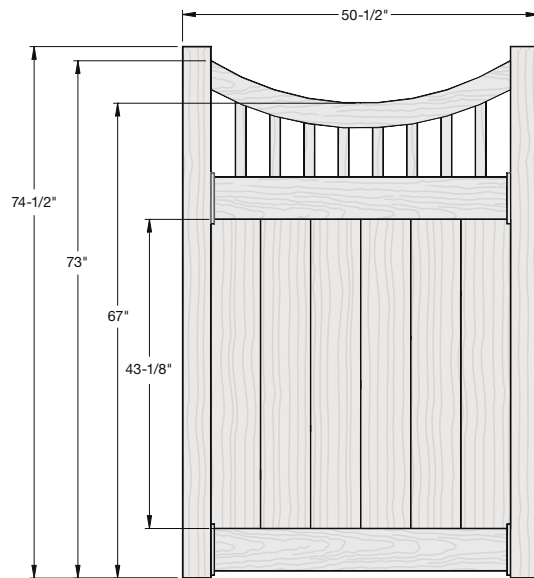

Chesterfield Concave

**Privacy
Chesterfield with CertaGrain
Texture and Spindle Accent**

6 ft. High / 8 ft. Wide

Select one of the available colors

- Arctic Blend ■ Brazilian Blend ■ Clay
- Sierra Blend ■ Weathered Blend
- White

For colors, add color letters to item number. Arctic Blend (AC4), Brazilian Blend (BR4), Clay (C), Sierra Blend (SB4), Weathered Blend (WB4). Note: Mixed color sections must be ordered as components; pricing will be higher than standard sections.

QUANTITY	PRODUCT NUMBER	DESCRIPTION
FENCE SECTIONS		
_____	30660	Chesterfield Fence Section with CertaGrain and Spindle Accent (6 ft. x 8 ft)
<i>Note: Fence section includes A, B C, D, E, F and section hardware. Post and caps sold separately.</i>		
5 IN. X 5 IN. POSTS		
_____	75401	Accent CertaGrain Corner Post 5 in. x 5 in. x 107 in.
_____	75402	Accent CertaGrain Line Post 5 in. x 5 in. x 107 in.
_____	71106	Aluminum 5 in. x 5 in. x 106 in. Line Post Stiffener
_____	75403	Accent CertaGrain End Post 5 in. x 5 in. x 107 in.
_____	759108	CertaGrain Blank Post Heavy Wall 5 in. x 5 in. x 107 in.
POST CAPS		
_____	70444	CertaGrain Flat Top Cap Ext 5 in. x 5 in.
_____	70459	Textured New England Cap 5 in. x 5 in.
GATES (hardware ordered separately)		
_____	31871	Gate Kit with Accent (builds up to 50-1/2 in. wide gate)
_____	70027	Gate Extension Kit (builds up to 70 in. gate) gate kit must also be ordered
_____	328091	CertaGrain Preassembled Gate with Spindle Accent 50-1/2 in. Wide
_____	70106	Aluminum 5 in. x 5 in. x 106 in. Gate Post Stiffener
_____	27635	Drop Pin Kit
_____	27742	5 ft. to 6 ft. Height Gate Hardware (self-closing hinges and latch)
_____	27745	Deluxe Key Entry Nylon Gate Hardware (5 ft. and 6 ft. height fence)
_____	27752	Plus Key Entry Nylon Gate Hardware (5 ft. and 6 ft. height fence)
_____	27747	LokkLatch Magnetic Gate Hardware (5 ft. and 6 ft. height fence)
_____	27731	Standard Stainless Steel Gate Hardware Pebble Black Finish
<i>Note: Gate kits include (2) 2-1/2 in. x 4 in. up-rights, caps and screws. Rails and pickets ordered separately.</i>		
OPTION/EXTRA MATERIAL		
_____	70090	Steel Reinforcement Channel x 92 in. for 2 in. x 6 in. Rail
_____	749795	CertaGrain 2 in. x 6 in. x 95 in. Top Rail - Spindle Accent
_____	744095	CertaGrain 2 in. x 6 in. x 95 in. Top/Bottom Rail with Steel
_____	60783P	Lock Rings (order 2 per rail) Qty: 24
_____	769049F	Chesterfield CertaGrain Fence Fill Kit 7/8 in. x 7 in. x 48-1/4 in. Tongue and Groove (13 pc)
_____	441520	3/4 in. round x 15-3/4 in. Accent Spindle Kit - Black (20 per kit)
_____	729794	CertaGrain 2 in. x 3-1/2 in. x 94-1/2 in. Routed Rail - Spindle Accent
_____	71414	2 in. EZ Set Post Brackets (pair with hardware - optional)
_____	26948	End Channel 7/8 in. x 1 in. x 47-7/8 in.

Note: End channels must be attached to posts.

- A TOP ACCENT RAIL** PALLET QUANTITY = 120
2" x 3-1/2" x 94-1/2"
Note: Arctic Blend, Brazilian Blend, Clay, Sierra Blend and Weathered Blend colors include steel in top rail.
- B ACCENT PICKET**
20 pieces of 3/4" round x 15-3/4" - Black
- C TOP RAIL** PALLET QUANTITY = 84
2" x 6" x 95" Rail ribbed.
Note: Arctic Blend, Brazilian Blend, Clay, Sierra Blend and Weathered Blend colors include steel in top rail.
- D PICKETS** PALLET QUANTITY = 12 Fill Kits
Section includes 13 pickets of 7/8" x 7" x 48-1/4"
- E END CHANNEL**
SUPPLIED: 7/8" x 1" x 47-7/8"
FIELD CUT: 7/8" x 1" x 45-1/2"
- F BOTTOM RAIL** PALLET QUANTITY = 84
2" x 6" x 95" Rail ribbed.
Includes steel channel.
- G POST** PALLET QUANTITY = 48
5" x 5" x 107"



**MEETS
POOL
CODE**

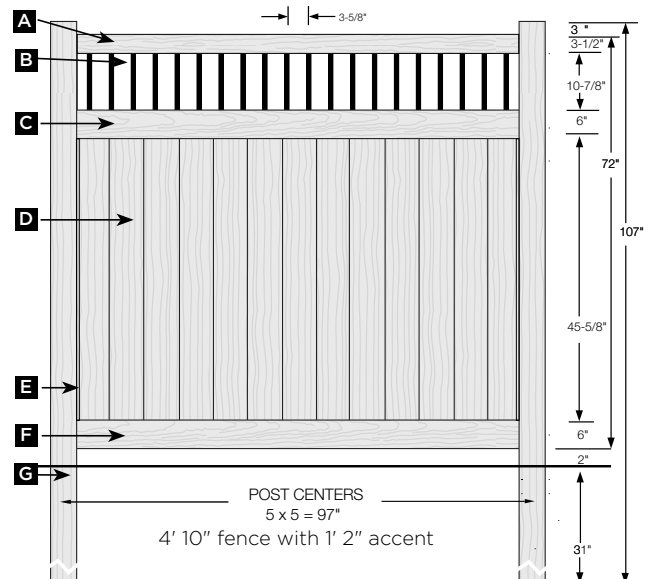

Racks up to 10 degrees*

***Accents will reduce the degree of rack.**

**Privacy
Chesterfield with CertaGrain
Texture Victorian Accent**

6 ft. High / 8 ft. Wide

Select one of the available colors
 ■ Almond ■ Arctic Blend
 ■ Brazilian Blend ■ Clay ■ Sierra Blend
 ■ Weathered Blend ■ White

For colors, add color letters to item number. Almond (AL), Clay (C), Arctic Blend (AC4), Brazilian Blend (BR4), Sierra Blend (SB4), Weathered Blend (WB4). Note: Mixed color sections must be ordered as components; pricing will be higher than standard sections.

QUANTITY	PRODUCT NUMBER	DESCRIPTION
FENCE SECTIONS		
_____	30650	Chesterfield Fence Section with CertaGrain and Victorian Accent (6 ft. x 8 ft.)
<i>Note: Fence section includes A, B, C, D, E, F and section hardware. Post and caps sold separately.</i>		
5 IN. X 5 IN. POSTS		
_____	75401	Accent CertaGrain Corner Post 5 in. x 5 in. x 107 in.
_____	75402	Accent CertaGrain Line Post 5 in. x 5 in. x 107 in.
_____	71106	Aluminum 5 in. x 5 in. x 106 in. Line Post Stiffener
_____	75403	Accent CertaGrain End Post 5 in. x 5 in. x 107 in.
_____	759108	CertaGrain Blank Post Heavy Wall 5 in. x 5 in. x 107 in.
POST CAPS		
_____	70444	CertaGrain Flat Top Cap Ext 5 in. x 5 in.
_____	70459	Textured New England Cap 5 in. x 5 in.
GATES (hardware ordered separately)		
_____	31871	Gate Kit with Accent (builds up to 50-1/2 in. wide gate)
_____	70027	Gate Extension Kit (builds up to 70 in. gate) gate kit must also be ordered
_____	318081	CertaGrain Preamsembled Gate with Victorian Accent 36-1/2 in. Wide
_____	328081	CertaGrain Preamsembled Gate with Victorian Accent 50-1/2 in. Wide
_____	338081	CertaGrain Preamsembled Gate with Victorian Accent 64-3/4 in. Wide
_____	70106	Aluminum 5 in. x 5 in. x 106 in. Gate Post Stiffener
_____	27635	Drop Pin Kit
_____	27742	5 ft. to 6 ft. Height Gate Hardware (self-closing hinges and latch)
_____	27745	Deluxe Key Entry Nylon Gate Hardware (5 ft. and 6 ft. height fence)
_____	27752	Plus Key Entry Nylon Gate Hardware (5 ft. and 6 ft. height fence)
_____	27747	LokkLatch Magnetic Gate Hardware (5 ft. and 6 ft. height fence)
_____	27731	Standard Stainless Steel Gate Hardware Pebble Black Finish
<i>Note: Gate kits include (2) 2-1/2 in. x 4 in. up-rights, caps and screws. Rails and pickets ordered separately.</i>		
OPTIONAL/EXTRA MATERIAL		
_____	70090	Steel Reinforcement Channel x 92 in. for 2 in. x 6 in. Rail
_____	749695	CertaGrain 2 in. x 6 in. x 95 in. Top Rail - Victorian Accent
_____	744095	CertaGrain 2 in. x 6 in. x 95 in. Top/Bottom Rail with Steel
_____	60783P	Lock Rings (order 2 per rail) Qty: 24
_____	769049F	Chesterfield CertaGrain Fence Fill Kit 7/8 in. x 7 in. x 48-1/4 in. Tongue and Groove (13 pc)
_____	889016	1-1/2 in. x 1-1/2 in. x 15-3/4 in. Accent Picket
_____	729694	CertaGrain 2 in. x 3-1/2 in. x 94-1/2 in. Routed Rail Victorian Accent
_____	71414	2 in. EZ Set Post Brackets (pair with hardware - optional)
_____	26948	End Channel 7/8 in. x 1 in. x 47-7/8 in.

Note: End channels must be attached to posts.

- A TOP ACCENT RAIL** PALLET QUANTITY = 120
2" x 3-1/2" x 94-1/2"
Note: Arctic Blend, Brazilian Blend, Clay, Sierra Blend and Weathered Blend colors include steel in top rail.
- B ACCENT PICKET**
17 pieces of 1-1/2" x 1-1/2" x 15-3/4"
- C TOP RAIL** PALLET QUANTITY = 84
2" x 6" x 95" Rail ribbed.
Note: Arctic Blend, Brazilian Blend, Clay, Sierra Blend and Weathered Blend colors include steel in top rail.
- D PICKETS** PALLET QUANTITY = 12 Fill Kits
Section includes 13 pickets of 7/8" x 7" x 48-1/4"
- E END CHANNEL**
SUPPLIED: 7/8" x 1" x 47-7/8"
FIELD CUT: 7/8" x 1" x 45-1/2"
- F BOTTOM RAIL** PALLET QUANTITY = 84
2" x 6" x 95" Rail ribbed.
Includes steel channel.
- G POST** PALLET QUANTITY = 48
5" x 5" x 107"



**MEETS
POOL
CODE**

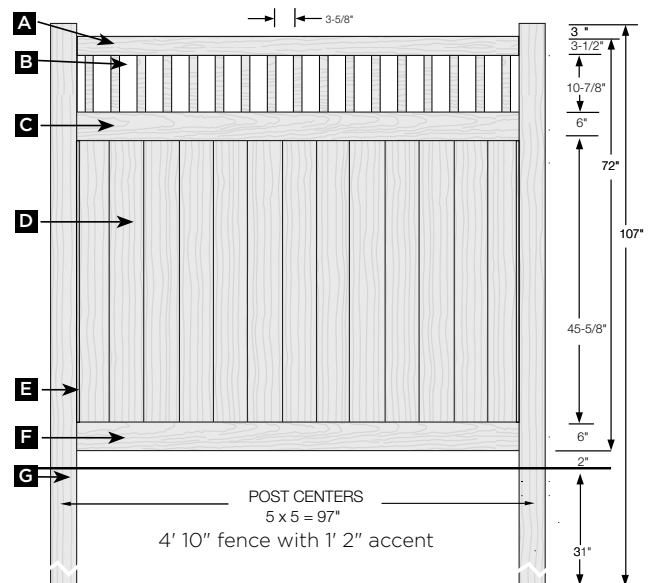

Racks up to 10 degrees*

***Accents will reduce the degree of rack.**

For Almond, add (AL) to item number.

Note: Mixed color sections must be ordered as components; pricing will be higher than standard sections.

QUANTITY	PRODUCT NUMBER	DESCRIPTION
FENCE SECTIONS		
_____	205584	Galveston Fence Section (7 ft. x 8 ft.)

Note: Fence section includes A, B, C, D, E and section hardware. Post and caps sold separately.

5 IN. X 5 IN. POSTS		
_____	67721	Corner Post 5 in. x 5 in. x 132 in.
_____	67722	Line Post 5 in. x 5 in. x 132 in.
_____	71106	Aluminum 5 in. x 5 in. x 106 in. Line Post Stiffener
_____	67723	End Post 5 in. x 5 in. x 132 in.
_____	679132	Blank Post Heavy Wall 5 in. x 5 in. x 132 in.

POST CAPS		
_____	70493	Ball Cap 5 in. x 5 in.
_____	70416	Gothic Cap Ext 5 in. x 5 in.
_____	70418	Flat Cap Ext 5 in. x 5 in.
_____	70427	New England Cap Ext 5 in. x 5 in.

GATES (hardware ordered separately)		
_____	42728	Gate Kit (builds up to 50-1/2 in. wide gate)
_____	437161	Preassembled Gate 50-1/2 in. Wide
_____	27635	Drop Pin Kit
_____	27743	Standard Nylon Gate Hardware (7 ft. and 8 ft. height fence)
_____	27746	Deluxe Key Entry Nylon Gate Hardware (7 ft. and 8 ft. height fence)
_____	27753	Plus Key Entry Nylon Gate Hardware (7 ft. and 8 ft. height fence)
_____	70106	Aluminum 5 in. x 5 in. x 106 in. Gate Post Stiffener

Note: Gate kits include (2) 2-1/2 in. x 4 in. up-rights, caps and screws. Rails and pickets ordered separately.

OPTIONAL/EXTRA MATERIAL		
_____	70090	Steel Reinforcement Channel x 92 in. for 2 in. x 6 in. Rail
_____	70094	Steel Reinforcement Channel 92 in. Length for 2 in. x 6 in. Molded Galveston Mid Rail
_____	58597	Galveston 2 in. x 6 in. x 95 in. Molded Mid Rail with Steel
_____	614895	2 in. x 6 in. x 95 in. Deco Top/Bottom Rail with Steel
_____	60783P	Lock Rings (order 2 per rail) Qty: 24
_____	469036F	Galveston Fence Fill Kit 7/8 in. x 7 in. x 35-7/8 in. Tongue and Groove (13 pc) order 2 per section
_____	16959	End Channel 7/8 in. x 1 in. x 59-7/8 in.

Note: All posts require reinforcement. Refer to the Bufftech Installation Manual. End channels must be attached to posts.

- A TOP RAIL** PALLET QUANTITY = 84
2" x 6" x 95" Deco rail ribbed.
Includes steel channel.
- B PICKETS** PALLET QUANTITY = 12 Fill Kits
Section includes 26 pickets of
7/8" x 7" x 35-7/8"
- C MIDDLE RAIL** PALLET QUANTITY = 84
2" x 6" x 95" molded rail ribbed.
Includes steel channel.
- D END CHANNEL**
SUPPLIED: 7/8" x 1" x 59-7/8"
FIELD CUT: 7/8" x 1" x 32-7/8"
- E BOTTOM RAIL** PALLET QUANTITY = 84
2" x 6" x 95" Deco rail ribbed.
Includes steel channel.
- F POST** PALLET QUANTITY = 48
5" x 5" x 132"

Racks up to 5 degrees

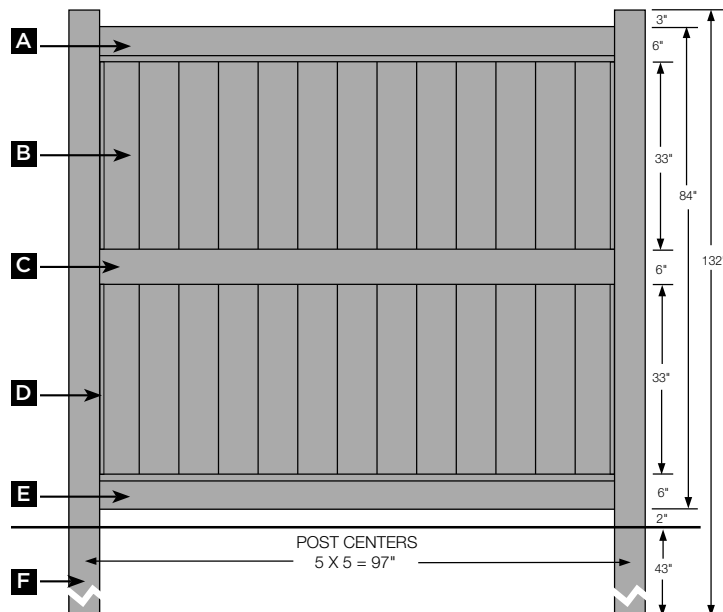

For Almond, add (AL) to item number.

Note: Mixed color sections must be ordered as components; pricing will be higher than standard sections.

QUANTITY	PRODUCT NUMBER	DESCRIPTION
FENCE SECTIONS		
_____	205596	Galveston Fence Section (8 ft. x 8 ft.)
<i>Note: Fence section includes A, B, C, D, E and section hardware. Post and caps sold separately.</i>		
5 IN. X 5 INC. POSTS		
_____	67731	Corner Post 5 in. x 5 in. x 132 in.
_____	67732	Line Post 5 in. x 5 in. x 132 in.
_____	71106	Aluminum 5 in. x 5 in. x 106 in. Line Post Stiffener
_____	67733	End Post 5 in. x 5 in. x 132 in.
_____	679132	Blank Post Heavy Wall 5 in. x 5 in. x 132 in.
POST CAPS		
_____	70493	Ball Cap 5 in. x 5 in.
_____	70416	Gothic Cap Ext 5 in. x 5 in.
_____	70418	Flat Cap Ext 5 in. x 5 in.
_____	70427	New England Cap Ext 5 in. x 5 in.
GATES (hardware ordered separately)		
_____	42729	Gate Kit (builds up to 50-1/2 in. wide gate)
_____	437162	Preassembled Gate 50-1/2 in. Wide
_____	27635	Drop Pin Kit
_____	27743	Standard Nylon Gate Hardware (7 ft. and 8 ft. height fence)
_____	27746	Deluxe Key Entry Nylon Gate Hardware (7 ft. and 8 ft. height fence)
_____	27753	Plus Key Entry Nylon Gate Hardware (7 ft. and 8 ft. height fence)
_____	70106	Aluminum 5 in. x 5 in. x 106 in. Gate Post Stiffener
<i>Note: Gate kits include (2) 2-1/2 in. x 4 in. up-rights, caps and screws. Rails and pickets ordered separately.</i>		
OPTIONAL/EXTRA MATERIAL		
_____	70090	Steel Reinforcement Channel x 92 in. for 2 in. x 6 in. Rail
_____	70094	Steel Reinforcement Channel 92 in. Length for 2 in. x 6 in. Molded Galveston Mid Rail
_____	58597	Galveston 2 in. x 6 in. x 95 in. Molded Mid Rail with Steel
_____	614895	2 in. x 6 in. x 95 in. Deco Top/Bottom Rail with Steel
_____	60783P	Lock Rings (order 2 per rail) Qty: 24
_____	469042F	Galveston Fence Fill Kit 7/8 in. x 7 in. x 41-7/8 in. Tongue and Groove (13 pc) order 2 per section
_____	16959	End Channel 7/8 in. x 1 in. x 59-7/8 in.

Note: All posts require reinforcement. Refer to the Bufftech Installation Manual. End channels must be attached to posts.

- A TOP RAIL** PALLET QUANTITY = 84
2" x 6" x 95" Deco rail ribbed.
Includes steel channel.
- B PICKETS** PALLET QUANTITY = 12 Fill Kits
Section includes 26 pickets of
7/8" x 7" x 41-7/8"
- C MIDDLE RAIL** PALLET QUANTITY = 84
2" x 6" x 95" molded rail ribbed.
Includes steel channel.
- D END CHANNEL**
SUPPLIED: 7/8" x 1" x 59-7/8"
FIELD CUT: 7/8" x 1" x 38-7/8"
- E BOTTOM RAIL** PALLET QUANTITY = 84
2" x 6" x 95" Deco rail ribbed.
Includes steel channel.
- F POST** PALLET QUANTITY = 48
5" x 5" x 132

Racks up to 5 degrees

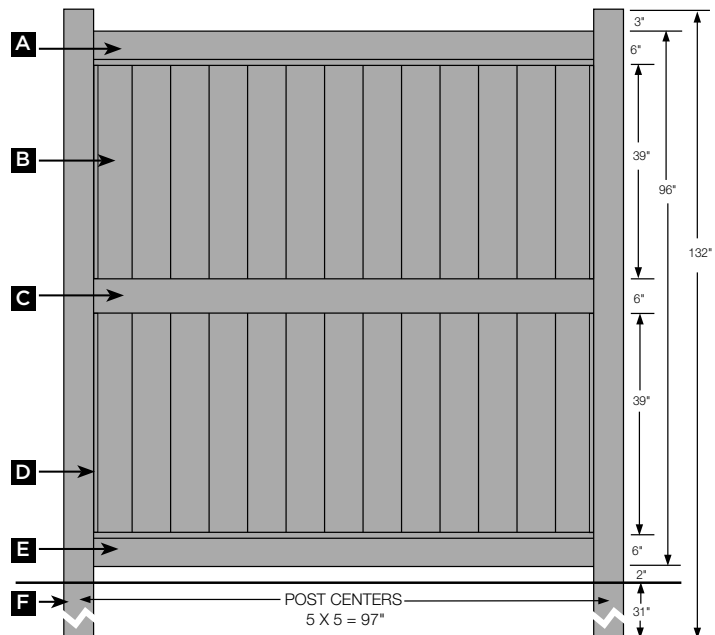

**Privacy
Galveston with Lattice
Accent**

8 ft. High / 8 ft. Wide

Select one of the available colors
 Almond White

For Almond, add (AL) to item number.

Note: Mixed color sections must be ordered as components; pricing will be higher than standard sections.

QUANTITY	PRODUCT NUMBER	DESCRIPTION
FENCE SECTIONS		
_____	220196	Galveston Fence Section with Lattice Accent (8 ft. x 8 ft.)
<i>Note: Fence section includes A, B, C, D, E, F, G, H, I and section hardware. Post and caps sold separately.</i>		
5 IN. X 5 IN. POSTS		
_____	67741	Corner Post 5 in. x 5 in. x 132 in.
_____	67742	Line Post 5 in. x 5 in. x 132 in.
_____	71106	Aluminum 5 in. x 5 in. x 106 in. Line Post Stiffener
_____	67743	End Post 5 in. x 5 in. x 132 in.
_____	679132	Blank Post Heavy Wall 5 in. x 5 in. x 132 in.
POST CAPS		
_____	70493	Ball Cap 5 in. x 5 in.
_____	70416	Gothic Cap Ext 5 in. x 5 in.
_____	70418	Flat Cap Ext 5 in. x 5 in.
_____	70427	New England Cap Ext 5 in. x 5 in.
GATES (hardware ordered separately)		
_____	42730	Gate Kit with Accent (builds up to 50-1/2 in. wide gate)
_____	437163	Preassembled Gate with Lattice Accent 50-1/2 in. Wide
_____	27635	Drop Pin Kit
_____	27743	Standard Nylon Gate Hardware (7 ft. and 8 ft. height fence)
_____	27746	Deluxe Key Entry Nylon Gate Hardware (7 ft. and 8 ft. height fence)
_____	27753	Plus Key Entry Nylon Gate Hardware (7 ft. and 8 ft. height fence)
_____	70106	Aluminum 5 in. x 5 in. x 106 in. Gate Post Stiffener
<i>Note: Gate kits include (2) 2-1/2 in. x 4 in. up-rights, caps and screws. Rails and pickets ordered separately.</i>		
OPTIONAL/EXTRA MATERIAL		
_____	70090	Steel Reinforcement Channel x 92 in. for 2 in. x 6 in. Rail
_____	70094	Steel Reinforcement Channel 92 in. Length for 2 in. x 6 in. Molded Galveston Mid Rail
_____	58597	Galveston 2 in. x 6 in. x 95 in. Molded Mid Rail with Steel
_____	614895	2 in. x 6 in. x 95 in. Deco Top/Bottom Rail with Steel
_____	290095	2 in. x 3-1/2 in. x 95 in. Accent Rail
_____	60783P	Lock Rings (order 2 per rail) Qty: 24
_____	17991	Horizontal Channel for Lattice 5/8 in. x 1 in. x 90-3/4 in.
_____	17913	Vertical Channel for Lattice 5/8 in. x 1 in. x 13-1/8 in.
_____	444129	13 in. x 91-1/2 in. Lattice Insert (diagonal)
_____	469033F	Galveston Fence Fill Kit 7/8 in. x 7 in. x 33-1/8 in. Tongue and Groove (13 pc) order 2 per section
_____	16959	End Channel 7/8 in. x 1 in. x 59-7/8 in.

Note: All posts require reinforcement. Refer to the Bufftech Installation Manual. End channels must be attached to posts.

- A TOP ACCENT RAIL** PALLET QUANTITY = 120
2" x 3-1/2" x 95"
- B LATTICE PANEL**
1 piece of 13" x 91-1/2"
1-1/4" x 1/4" Strips.
- C VERTICAL CHANNEL**
2 pieces of 5/8" x 1" x 13-1/8"
- D HORIZONTAL CHANNEL**
2 pieces of 5/8" x 1" x 90-3/4"
- E TOP RAIL** PALLET QUANTITY = 84
2" x 6" x 95" Deco rail ribbed. Includes steel channel.
- F PICKETS** PALLET QUANTITY = 12 Fill Kits
Section includes 26 pickets of 7/8" x 7" x 33-1/8"
- G MIDDLE RAIL** PALLET QUANTITY = 84
2" x 6" x 95" molded rail ribbed includes steel channel.
- H END CHANNEL**
SUPPLIED: 7/8" x 1" x 59-7/8"
FIELD CUT: 7/8" x 1" x 30-7/16"
- I BOTTOM RAIL** PALLET QUANTITY = 84
2" x 6" x 95" Deco rail ribbed. Includes steel channel.
- J POST** PALLET QUANTITY = 48
5" x 5" x 132"

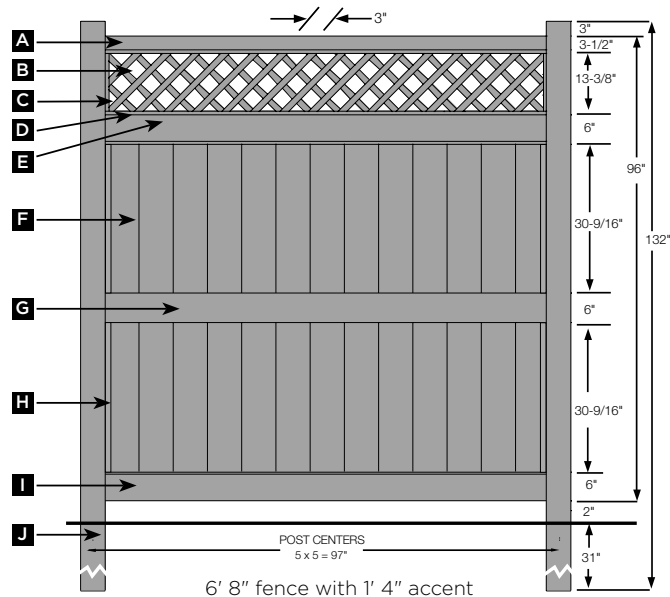

Racks up to 5 degrees*

***Accents will reduce the degree of rack.**

**Privacy
Galveston with Victorian
Accent**

8 ft. High / 8 ft. Wide

Select one of the available colors
 Almond White

For Almond, add (AL) to item number.

Note: Mixed color sections must be ordered as components; pricing will be higher than standard sections.

QUANTITY	PRODUCT NUMBER	DESCRIPTION
FENCE SECTIONS		
_____	220296	Galveston Fence Section with Victorian Accent (8 ft. x 8 ft.)
<i>Note: Fence section includes A, B, C, D, E, F, G and section hardware. Post and caps sold separately.</i>		
5 IN. X 5 IN. POSTS		
_____	67741	Corner Post 5 in. x 5 in. x 132 in.
_____	67742	Line Post 5 in. x 5 in. x 132 in.
_____	71106	Aluminum 5 in. x 5 in. x 106 in. Line Post Stiffener
_____	67743	End Post 5 in. x 5 in. x 132 in.
_____	679132	Blank Post Heavy Wall 5 in. x 5 in. x 132 in.
POST CAPS		
_____	70493	Ball Cap 5 in. x 5 in.
_____	70416	Gothic Cap Ext 5 in. x 5 in.
_____	70418	Flat Cap Ext 5 in. x 5 in.
_____	70427	New England Cap Ext 5 in. x 5 in.
GATES (hardware ordered separately)		
_____	42730	Gate Kit with Accent (builds up to 50-1/2 in. wide gate)
_____	437164	Preassembled Gate with Victorian Accent 50-1/2 in. Wide
_____	27635	Drop Pin Kit
_____	27743	Standard Nylon Gate Hardware (7 ft. and 8 ft. height fence)
_____	27746	Deluxe Key Entry Nylon Gate Hardware (7 ft. and 8 ft. height fence)
_____	27753	Plus Key Entry Nylon Gate Hardware (7 ft. and 8 ft. height fence)
_____	70106	Aluminum 5 in. x 5 in. x 106 in. Gate Post Stiffener
<i>Note: Gate kits include (2) 2-1/2 in. x 4 in. up-rights, caps and screws. Rails and pickets ordered separately.</i>		
OPTIONAL/EXTRA MATERIAL		
_____	70090	Steel Reinforcement Channel x 92 in. for 2 in. x 6 in. Rail
_____	70094	Steel Reinforcement Channel 92 in. Length for 2 in. x 6 in. Molded Galveston Mid Rail
_____	61998	Galveston 2 in. x 6 in. x 95 in. Deco Top Rail with Steel - Victorian Accent
_____	58597	Galveston 2 in. x 6 in. x 95 in. Molded Mid Rail with Steel
_____	614895	2 in. x 6 in. x 95 in. Deco Top/Bottom Rail with Steel
_____	60783P	Lock Rings (order 2 per rail) Qty: 24
_____	319017	7/8 in. x 1-1/2 in. x 17-3/4 in. Accent Picket
_____	290565	2 in. x 3-1/2 in. x 95 in. Routed Rail Victorian Accent
_____	469033F	Galveston Fence Fill Kit 7/8 in. x 7 in. x 33-1/8 in. Tongue and Groove (13 pc) order 2 per section
_____	16959	End Channel 7/8 in. x 1 in. x 59-7/8 in.

Note: All posts require reinforcement. Refer to the Bufftech Installation Manual. End channels must be attached to posts.

- A ACCENT TOP RAIL** PALLET QUANTITY = 120
2" x 3-1/2" x 95"
- B PICKETS**
17 pieces of 7/8" x 1-1/2" x 17-3/4"
- C TOP RAIL**
PALLET QUANTITY = 84
2" x 6" x 95" Deco rail ribbed.
Includes steel channel.
- D PICKETS** PALLET QUANTITY = 12 Fill Kits
Section includes 26 pickets of 7/8" x 7" x 33-1/8"
- E MIDDLE RAIL** PALLET QUANTITY = 84
2" x 6" x 95" molded rail ribbed. Includes steel channel.
- F END CHANNEL**
SUPPLIED: 7/8" x 1" x 59-7/8"
FIELD CUT: 7/8" x 1" x 30-7/16"
- G BOTTOM RAIL** PALLET QUANTITY = 84
2" x 6" x 95" Deco rail ribbed.
Includes steel channel.
- H POST** PALLET QUANTITY = 48
5" x 5" x 132"

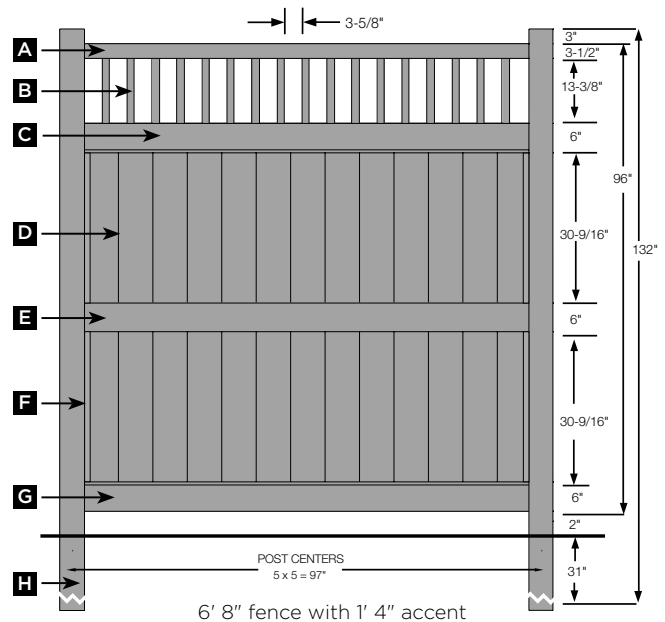

Racks up to 5 degrees*
***Accents will reduce the degree of rack**

**Privacy
Galveston with CertaGrain
Texture**

7 ft. High / 8 ft. Wide

Select one of the available colors

- Arbor Blend ■ Arctic Blend
- Brazilian Blend ■ Clay
- Frontier Blend ■ Sierra Blend
- Weathered Blend

For colors, add color letters to item number: Arbor Blend (AR4), Arctic Blend (AC4), Brazilian Blend (BR4), Clay (C), Frontier Blend (FB4), Sierra Blend (SB4), Weathered Blend (WB4). Note: Mixed color sections must be ordered as components; pricing will be higher than standard sections.

QUANTITY	PRODUCT NUMBER	DESCRIPTION
FENCE SECTIONS		
_____	31684	Galveston Fence Section with CertaGrain Texture (7 ft. x 8 ft.)
<i>Note: Fence section includes A, B, C, D, E and section hardware. Post and caps sold separately.</i>		
5 IN. X 5 IN. POSTS		
_____	75521	CertaGrain Corner Post 5 in. x 5 in. x 132 in.
_____	75522	CertaGrain Line Post 5 in. x 5 in. x 132 in.
_____	71106	Aluminum 5 in. x 5 in. x 106 in. Line Post Stiffener
_____	75523	CertaGrain End Post 5 in. x 5 in. x 132 in.
_____	759132	CertaGrain Blank Post Heavy Wall 5 in. x 5 in. x 132 in.
POST CAPS		
_____	70444	CertaGrain Flat Top Cap Ext 5 in. x 5 in.
_____	70459	Textured New England Cap 5 in. x 5 in.
GATES (Hardware ordered separately)		
_____	31884	Gate Kit (builds up to 50-1/2 in. wide gate)
_____	328184	Preassembled Gate with CertaGrain 50-1/2 in. Wide
_____	27743	Standard Nylon Gate Hardware (7 ft. and 8 ft. height fence)
_____	27746	Deluxe Key Entry Nylon Gate Hardware (7 ft. and 8 ft. height fence)
_____	27753	Plus Key Entry Nylon Gate Hardware (7 ft. and 8 ft. height fence)
_____	70106	Aluminum 5 in. x 5 in. x 106 in. Gate Post Stiffener
<i>Note: Gate kits include (2) 2-1/2 in. x 4 in. up-rights, caps and screws. Rails and pickets ordered separately.</i>		
OPTIONAL/EXTRA MATERIAL		
_____	70090	Steel Reinforcement Channel x 92 in. for 2 in. x 6 in. Rail
_____	70094	Steel Reinforcement Channel 92 in. Length for 2 in. x 6 in. Molded Galveston Mid Rail
_____	809952	Galveston CertaGrain 2 in. x 6 in. x 95 in. Molded Mid Rail with Steel
_____	744095	CertaGrain 2 in. x 6 in. x 95 in. Top/Bottom Rail with Steel
_____	60783P	Lock Rings (order 2 per rail) Qty: 24
_____	769036F	Galveston CertaGrain Fence Fill Kit 7/8 in. x 7 in. x 35-7/8 in. Tongue and Groove (13 pc) order 2 per section
_____	26948	End Channel 7/8 in. x 1 in. x 47-7/8 in.

Note: All posts require reinforcement. Refer to the Bufftech Installation Manual. End channels must be attached to posts.

- A TOP RAIL** PALLET QUANTITY = 84
2" x 6" x 95" rail ribbed.
Includes steel channel.
- B PICKETS** PALLET QUANTITY = 12 Fill Kits
Section includes 26 pickets of
7/8" x 7" x 35-7/8"
- C MIDDLE RAIL** PALLET QUANTITY = 84
2" x 6" x 95" molded rail ribbed.
Includes steel channel.
- D END CHANNEL**
SUPPLIED: 7/8" x 1" x 47-7/8"
FIELD CUT: 7/8" x 1" x 32-7/8"
- E BOTTOM RAIL** PALLET QUANTITY = 84
2" x 6" x 95" rail ribbed.
Includes steel channel.
- F POST** PALLET QUANTITY = 48
5" x 5" x 132"

Racks up to 5 degrees

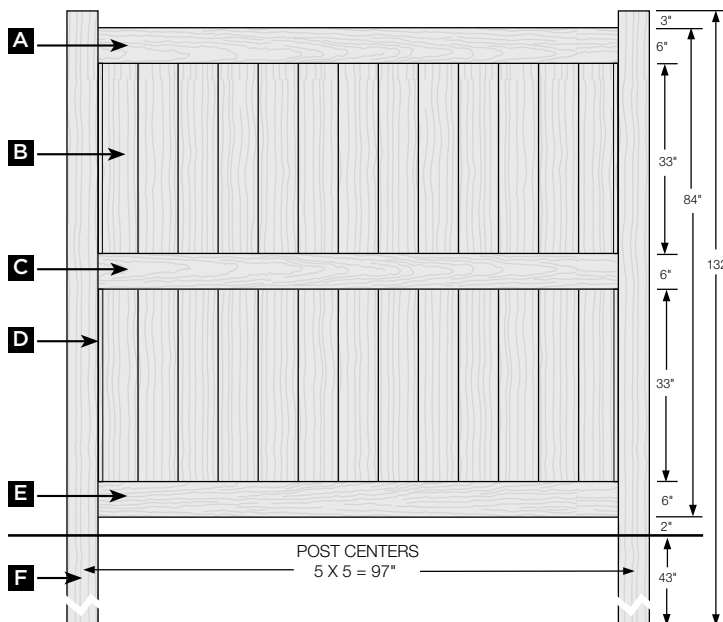

**Privacy
Galveston with CertaGrain
Texture**

8 ft. High / 8 ft. Wide

Select one of the available colors

- Arbor Blend ■ Arctic Blend
- Brazilian Blend ■ Clay
- Frontier Blend ■ Sierra Blend
- Weathered Blend

For colors, add color letters to item number: Arbor Blend (AR4), Arctic Blend (AC4), Brazilian Blend (BR4), Clay (C), Frontier Blend (FB4), Sierra Blend (SB4), Weathered Blend (WB4). Note: Mixed color sections must be ordered as components; pricing will be higher than standard sections.

QUANTITY	PRODUCT NUMBER	DESCRIPTION
FENCE SECTIONS		
_____	31696	Galveston Fence Section with CertaGrain Texture (8 ft. x 8 ft.)
<i>Note: Fence section includes A, B, C, D, E and section hardware. Post and caps sold separately.</i>		
5 IN. X 5 IN. POSTS		
_____	75631	CertaGrain Corner Post 5 in. x 5 in. x 132 in.
_____	75632	CertaGrain Line Post 5 in. x 5 in. x 132 in.
_____	71106	Aluminum 5 in. x 5 in. x 106 in. Line Post Stiffener
_____	75633	CertaGrain End Post 5 in. x 5 in. x 132 in.
_____	759132	CertaGrain Blank Post Heavy Wall 5 in. x 5 in. x 132 in.
POST CAPS		
_____	70444	CertaGrain Flat Top Cap Ext 5 in. x 5 in.
_____	70459	Textured New England Cap 5 in. x 5 in.
GATES (hardware ordered separately)		
_____	31896	Gate Kit (builds up to 50-1/2 in. wide gate)
_____	328196	Preassembled Gate with CertaGrain 50-1/2 in. Wide
_____	27743	Standard Nylon Gate Hardware (7 ft. and 8 ft. height fence)
_____	27746	Deluxe Key Entry Nylon Gate Hardware (7 ft. and 8 ft. height fence)
_____	27753	Plus Key Entry Nylon Gate Hardware (7 ft. and 8 ft. height fence)
_____	70106	Aluminum 5 in. x 5 in. x 106 in. Gate Post Stiffener
<i>Note: Gate kits include (2) 2-1/2 in. x 4 in. up-rights, caps and screws. Rails and pickets ordered separately.</i>		
OPTIONAL/EXTRA MATERIAL		
_____	70090	Steel Reinforcement Channel x 92 in. for 2 in. x 6 in. Rail
_____	70094	Steel Reinforcement Channel 92 in. Length for 2 in. x 6 in. Molded Galveston Mid Rail
_____	809952	Galveston CertaGrain 2 in. x 6 in. x 95 in. Molded Mid Rail with Steel
_____	744095	CertaGrain 2 in. x 6 in. x 95 in. Top/Bottom Rail with Steel
_____	60783P	Lock Rings (order 2 per rail) Qty: 24
_____	769042F	Galveston CertaGrain Fence Fill Kit 7/8 in. x 7 in. x 41-7/8 in. Tongue and Groove (13 pc) order 2 per section
_____	26948	End Channel 7/8 in. x 1 in. x 47-7/8 in.

Note: All posts require reinforcement. Refer to the Bufftech Installation Manual. End channels must be attached to posts.

- A TOP RAIL** PALLET QUANTITY = 84
2" x 6" x 95" rail ribbed.
Includes steel channel.
- B PICKETS** PALLET QUANTITY = 12 Fill Kits
Section includes 26 pickets of
7/8" x 7" x 41-7/8"
- C MIDDLE RAIL** PALLET QUANTITY = 84
2" x 6" x 95" molded rail ribbed.
Includes steel channel.
- D END CHANNEL**
SUPPLIED: 7/8" x 1" x 47-7/8"
FIELD CUT: 7/8" x 1" x 38-7/8"
- E BOTTOM RAIL** PALLET QUANTITY = 84
2" x 6" x 95" rail ribbed.
Includes steel channel.
- F POST** PALLET QUANTITY = 48
5" x 5" x 132"

Racks up to 5 degrees

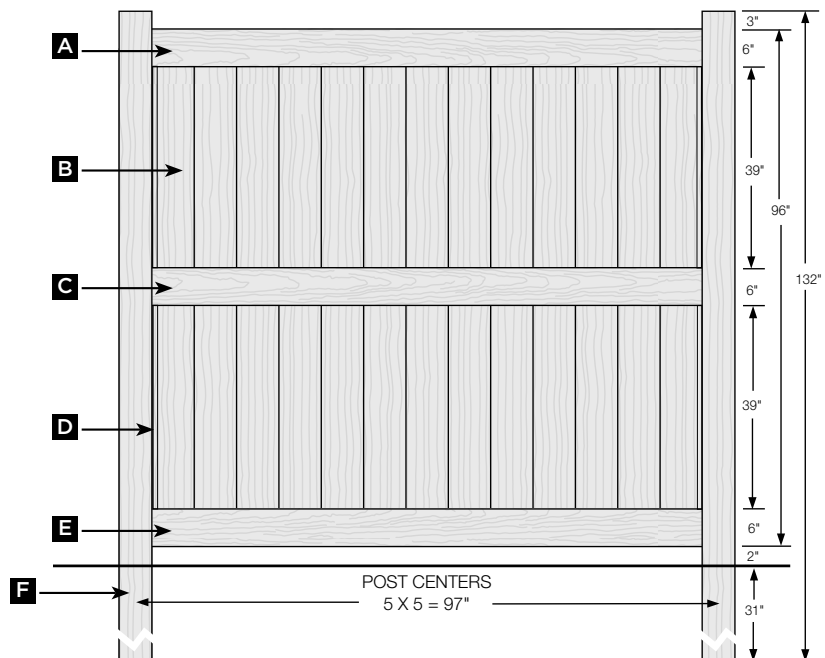

For Almond, add (AL) to item number.

Note: Mixed color sections must be ordered as components; pricing will be higher than standard sections.

QUANTITY	PRODUCT NUMBER	DESCRIPTION
FENCE SECTIONS		
_____	218440	New Lexington Fence Section (4 ft. x 8 ft.)

Note: Fence section includes A, B, C, D and section hardware. Post and caps sold separately.

5 IN. X 5 IN. POSTS		
_____	535414	Corner Post 5 in. x 5 in. x 78 in.
_____	535424	Line Post 5 in. x 5 in. x 78 in.
_____	535434	End Post 5 in. x 5 in. x 78 in.
_____	539078	Blank Post 5 in. x 5 in. x 78 in.

POST CAPS		
_____	70493	Ball Cap 5 in. x 5 in.
_____	70416	Gothic Cap Ext 5 in. x 5 in.
_____	70417	Flat Cap Int 5 in. x 5 in.
_____	70418	Flat Cap Ext 5 in. x 5 in.
_____	70427	New England Cap Ext 5 in. x 5 in.

GATES (hardware ordered separately)		
_____	42732	New Lexington Gate Kit (builds up to 42-1/2 in. wide gate)
_____	70033F	New Lexington Gate Extension Kit (builds up to 72 in. gate) gate kit must also be ordered
_____	437066	New Lexington Preassembled Gate 42-1/2 in. Wide
_____	457066	New Lexington Preassembled Gate 50-1/2 in. Wide
_____	447066	New Lexington Preassembled Gate 65-1/4 in. Wide
_____	70095	Aluminum 5 in. x 5 in. x 94 in. Gate Post Stiffener
_____	27635	Drop Pin Kit
_____	27742	5 ft. to 6 ft. Height Gate Hardware (self-closing hinges and latch)
_____	27745	Deluxe Key Entry Nylon Gate Hardware (5 ft. and 6 ft. height fence)
_____	27752	Plus Key Entry Nylon Gate Hardware (5 ft. and 6 ft. height fence)
_____	27747	LokkLatch Magnetic Gate Hardware (5 ft. and 6 ft. height fence)
_____	27731	Standard Stainless Steel Gate Hardware Pebble Black Finish

Note: Gate kits include (2) 2-1/2 in. x 4 in. up-rights, caps and screws. Rails and pickets ordered separately.

OPTIONAL/EXTRA MATERIAL		
_____	70093F	Steel Reinforcement Channel x 90-3/4 in. for 1-1/2 in. x 5-1/2 in. Rail
_____	629294	New Lexington 1-1/2 in. x 5-1/2 in. x 95 in. Deco Top Rail
_____	629295	New Lexington 1-1/2 in. x 5-1/2 in. x 95 in. Deco Bottom Rail with Steel
_____	60783P	Lock Rings (order 2 per rail) Qty: 24
_____	479039F	New Lexington Fence Fill Kit 5/8 x 11-3/8 x 39-3/4 Tongue & Groove (8 pk)
_____	71414	2 in. EZ Set Post Brackets (pair with hardware - optional)
_____	17961	End Channel 5/8 in. x 1 in. x 60-7/8 in.

Note: End channels must be attached to posts.

- A TOP RAIL** PALLET QUANTITY = 96
1-1/2" x 5-1/2" x 95" Deco rail ribbed.
- B PICKETS** PALLET QUANTITY = 16 Fill Kits
Section includes 8 pickets of
5/8" x 11-3/8" x 39-3/4"
- C END CHANNEL**
SUPPLIED: 5/8" x 1" x 60-7/8"
FIELD CUT: 7/8" x 1" x 36-7/8"
- D BOTTOM RAIL** PALLET QUANTITY = 96
1-1/2" x 5-1/2" x 95" Deco rail ribbed. Includes
steel channel.
- E POST** PALLET QUANTITY = 28
5" x 5" x 78"

Racks up to 7 degrees

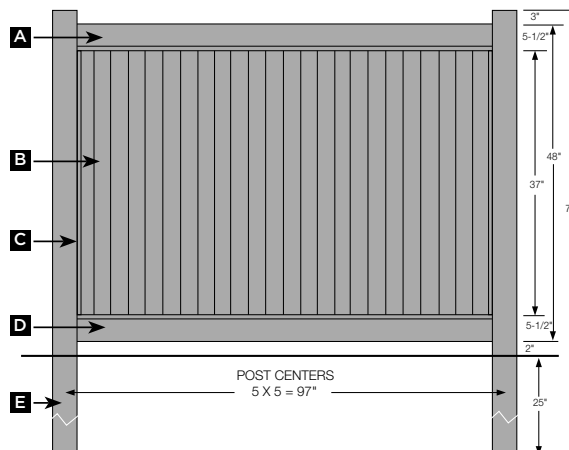

For Almond, add (AL) to item number.

Note: Mixed color sections must be ordered as components; pricing will be higher than standard sections.

QUANTITY	PRODUCT NUMBER	DESCRIPTION
FENCE SECTIONS		
_____	218560	New Lexington Fence Section (5 ft. x 8 ft.)

Note: Fence section includes A, B, C, D and section hardware. Post and caps sold separately.

5 IN. X 5 IN. POSTS		
_____	536515	Corner Post 5 in. x 5 in. x 96 in.
_____	536525	Line Post 5 in. x 5 in. x 96 in.
_____	536535	End Post 5 in. x 5 in. x 96 in.
_____	539096	Blank Post 5 in. x 5 in. x 96 in.

POST CAPS		
_____	70493	Ball Cap 5 in. x 5 in.
_____	70416	Gothic Cap Ext 5 in. x 5 in.
_____	70417	Flat Cap Int 5 in. x 5 in.
_____	70418	Flat Cap Ext 5 in. x 5 in.
_____	70427	New England Cap Ext 5 in. x 5 in.

GATES (hardware ordered separately)		
_____	42790	New Lexington Gate Kit (builds up to 42-1/2 in. wide gate)
_____	70033F	New Lexington Gate Extension Kit (builds up to 72 in. gate) gate kit must also be ordered
_____	437085	New Lexington Preassembled Gate 42-1/2 in. Wide
_____	457085	New Lexington Preassembled Gate 50-1/2 in. Wide
_____	447085	New Lexington Preassembled Gate 65-1/4 in. Wide
_____	70095	Aluminum 5 in. x 5 in. x 94 in. Gate Post Stiffener
_____	27635	Drop Pin Kit
_____	27742	5 ft. to 6 ft. Height Gate Hardware (self-closing hinges and latch)
_____	27745	Deluxe Key Entry Nylon Gate Hardware (5 ft. and 6 ft. height fence)
_____	27752	Plus Key Entry Nylon Gate Hardware (5 ft. and 6 ft. height fence)
_____	27747	LokkLatch Magnetic Gate Hardware (5 ft. and 6 ft. height fence)
_____	27731	Standard Stainless Steel Gate Hardware Pebble Black Finish

Note: Gate kits include (2) 2-1/2 in. x 4 in. up-rights, caps and screws. Rails and pickets ordered separately.

OPTIONAL/EXTRA MATERIAL		
_____	70093F	Steel Reinforcement Channel x 90-3/4 in. for 1-1/2 in. x 5-1/2 in. Rail
_____	629294	New Lexington 1-1/2 in. x 5-1/2 in. x 95 in. Deco Top Rail
_____	629295	New Lexington 1-1/2 in. x 5-1/2 in. x 95 in. Deco Bottom Rail with Steel
_____	60783P	Lock Rings (order 2 per rail) Qty: 24
_____	479052F	New Lexington Fence Fill Kit 5/8 in. x 11-3/8 in. x 51-3/4 in. Tongue and Groove (8 pc)
_____	71414	2 in. EZ Set Post Brackets (pair with hardware - optional)
_____	17961	End Channel 5/8 in. x 1 in. x 60-7/8 in.

Note: End channels must be attached to posts.

- A TOP RAIL** PALLET QUANTITY = 96
1-1/2" x 5-1/2" x 95" Deco rail ribbed.
- B PICKETS** PALLET QUANTITY = 16 Fill Kits
Section includes 8 pickets of 5/8" x 11-3/8" x 51-3/4"
- C END CHANNEL**
SUPPLIED: 5/8" x 1" x 60-7/8"
FIELD CUT: 5/8" x 1" x 48-7/8"
- D BOTTOM RAIL** PALLET QUANTITY = 96
1-1/2" x 5-1/2" x 95" Deco rail ribbed.
Includes steel channel.
- E POST** PALLET QUANTITY = 48
5" x 5" x 96"

Racks up to 7 degrees

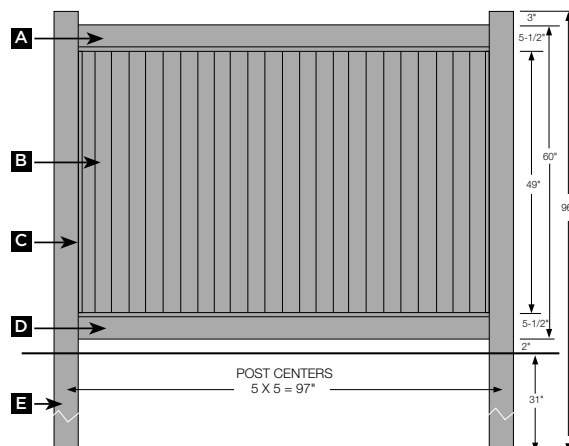

For Almond, add (AL) to item number.

Note: Mixed color sections must be ordered as components; pricing will be higher than standard sections.

QUANTITY	PRODUCT NUMBER	DESCRIPTION
FENCE SECTIONS		
_____	218002	New Lexington Fence Section (6 ft. x 8 ft.)

Note: Fence section includes A, B, C, D and section hardware. Post and caps sold separately.

5 IN. X 5 IN. POSTS		
_____	536014	Corner Post 5 in. x 5 in. x 107 in.
_____	536024	Line Post 5 in. x 5 in. x 107 in.
_____	536034	End Post 5 in. x 5 in. x 107 in.
_____	539108	Blank Post 5 in. x 5 in. x 107 in.

POST CAPS		
_____	70493	Ball Cap 5 in. x 5 in.
_____	70416	Gothic Cap Ext 5 in. x 5 in.
_____	70417	Flat Cap Int 5 in. x 5 in.
_____	70418	Flat Cap Ext 5 in. x 5 in.
_____	70427	New England Cap Ext 5 in. x 5 in.

GATES (hardware ordered separately)		
_____	42736	New Lexington Gate Kit (builds up to 42-1/2 in. wide gate)
_____	70033F	New Lexington Gate Extension Kit (builds up to 72 in. gate) gate kit must also be ordered
_____	437070	New Lexington Preamsembled Gate 42-1/2 in. Wide
_____	457070	New Lexington Preamsembled Gate 50-1/2 in. Wide
_____	447070	New Lexington Preamsembled Gate 65-1/4 in. Wide
_____	70106	Aluminum 5 in. x 5 in. x 106 in. Gate Post Stiffener
_____	70095	Aluminum 5 in. x 5 in. x 94 in. Gate Post Stiffener
_____	27635	Drop Pin Kit
_____	27742	5 ft. to 6 ft. Height Gate Hardware (self-closing hinges and latch)
_____	27745	Deluxe Key Entry Nylon Gate Hardware (5 ft. and 6 ft. height fence)
_____	27752	Plus Key Entry Nylon Gate Hardware (5 ft. and 6 ft. height fence)
_____	27747	LokkLatch Magnetic Gate Hardware (5 ft. and 6 ft. height fence)
_____	27731	Standard Stainless Steel Gate Hardware Pebble Black Finish

Note: Gate kits include (2) 2-1/2 in. x 4 in. up-rights, caps, and screws. Rails and pickets ordered separately.

OPTIONAL/EXTRA MATERIAL		
_____	70093F	Steel Reinforcement Channel x 90-3/4 in. for 1-1/2 in. x 5-1/2 in. Rail
_____	629294	New Lexington 1-1/2 in. x 5-1/2 in. x 95 in. Deco Top Rail
_____	629295	New Lexington 1-1/2 in. x 5-1/2 in. x 95 in. Deco Bottom Rail with Steel
_____	60783P	Lock Rings (order 2 per rail) Qty: 24
_____	479063F	New Lexington Fence Fill Kit 5/8 in. x 11-3/8 in. x 63-3/4 in. Tongue and Groove (8 pc)
_____	71414	2 in. EZ Set Post Brackets (pair with hardware - optional)
_____	479072	New Lexington 5/8 in. x 11-3/8 in. x 72 in. Tongue and Groove Picket
_____	17961	End Channel 5/8 in. x 1 in. x 60-7/8 in.
_____	70787P	#8 x 1-1/2 in. Stainless Steel Screw Qty: 100
_____	70792P	Snap Cap Washer Qty: 100
_____	70793P	Snap Cap Qty: 100

Note: End channels must be attached to posts.

For improved wind performance, please refer to the Bufftech installation instructions.

- A TOP RAIL** PALLET QUANTITY = 96
1-1/2" x 5-1/2" x 95" Deco rail ribbed.
- B PICKETS** PALLET QUANTITY = 16 Fill Kits
Section includes 8 pickets of 5/8" x 11-3/8" x 63-3/4"
- C END CHANNEL**
5/8" x 1" x 60-7/8"
- D BOTTOM RAIL** PALLET QUANTITY = 96
1-1/2" x 5-1/2" x 95" Deco rail ribbed.
Includes steel channel.
- E POST** PALLET QUANTITY = 48
5" x 5" x 107"
5" x 5" x 96"

Racks up to 7 degrees

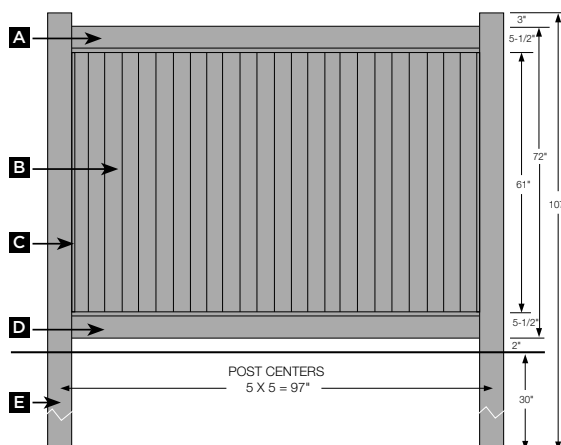

**Privacy
New Lexington S Curve**

**6 ft. High / 8 ft. Wide / 24
in. Drop**

Select one of the available colors
■ Almond ■ White

For Almond, add (AL) to item number.

Note: Mixed color sections must be ordered as components; pricing will be higher than standard sections.

QUANTITY	PRODUCT NUMBER	DESCRIPTION
FENCE SECTIONS		
_____	218101	New Lexington Fence Section with S Curve (6 ft. x 8 ft. with 24 in. drop)
<i>Note: Fence section includes A, B, C, D and section hardware. Post and caps sold separately. Curved rail pre-cut for 8 ft. panel; pickets must be field cut. Post for S Curve is standard Lexington post.</i>		
5 IN. X 5 IN. POSTS - 6 FT. END		
_____	536014	Corner Post 5 in. x 5 in. x 107 in.
_____	536024	Line Post 5 in. x 5 in. x 107 in.
_____	536034	End Post 5 in. x 5 in. x 107 in.
_____	539108	Blank Post 5 in. x 5 in. x 107 in.
5 IN. X 5 IN. POSTS - 4 FT. END		
_____	535414	Corner Post 5 in. x 5 in. x 78 in.
_____	535424	Line Post 5 in. x 5 in. x 78 in.
_____	535434	End Post 5 in. x 5 in. x 78 in.
_____	539078	Blank Post 5 in. x 5 in. x 78 in.
POST CAPS		
_____	70493	Ball Cap 5 in. x 5 in.
_____	70416	Gothic Cap Ext 5 in. x 5 in.
_____	70417	Flat Cap Int 5 in. x 5 in.
_____	70418	Flat Cap Ext 5 in. x 5 in.
_____	70427	New England Cap Ext 5 in. x 5 in.
OPTIONAL/EXTRA MATERIAL		
_____	70093F	Steel Reinforcement Channel x 90-3/4 in. for 1-1/2 in. x 5-1/2 in. Rail
_____	629321	1-1/2 in. x 5-1/2 in. x 108 in. Deco S Curve Top Rail
_____	629295	New Lexington 1-1/2 in. x 5-1/2 in. x 95 in. Deco Bottom Rail with Steel
_____	60783P	Lock Rings (order 2 per rail) Qty: 24
_____	479063F	New Lexington Fence Fill Kit 5/8 in. x 11-3/8 in. x 63-3/4 in. Tongue and Groove (8 pc)
_____	71414	2 in. EZ Set Post Brackets (pair with hardware - optional)
_____	17961	End Channel 5/8 in. x 1 in. x 60-7/8 in.

Note: End channels must be attached to posts. Pickets require field cutting.

- A TOP RAIL**
1-1/2" x 5-1/2" x 108"
S Curve Deco rail ribbed.
- B PICKETS**
Section includes
8 pickets of
5/8" x 11-3/8" x 63-3/4"
- C END CHANNEL**
5/8" x 1" x 60-7/8"
- D BOTTOM RAIL**
1-1/2" x 5-1/2" x 95"
Deco rail ribbed.
Includes steel channel.
- E POST**
5" x 5" x 96"
- F POST**
5" x 5" x 72"

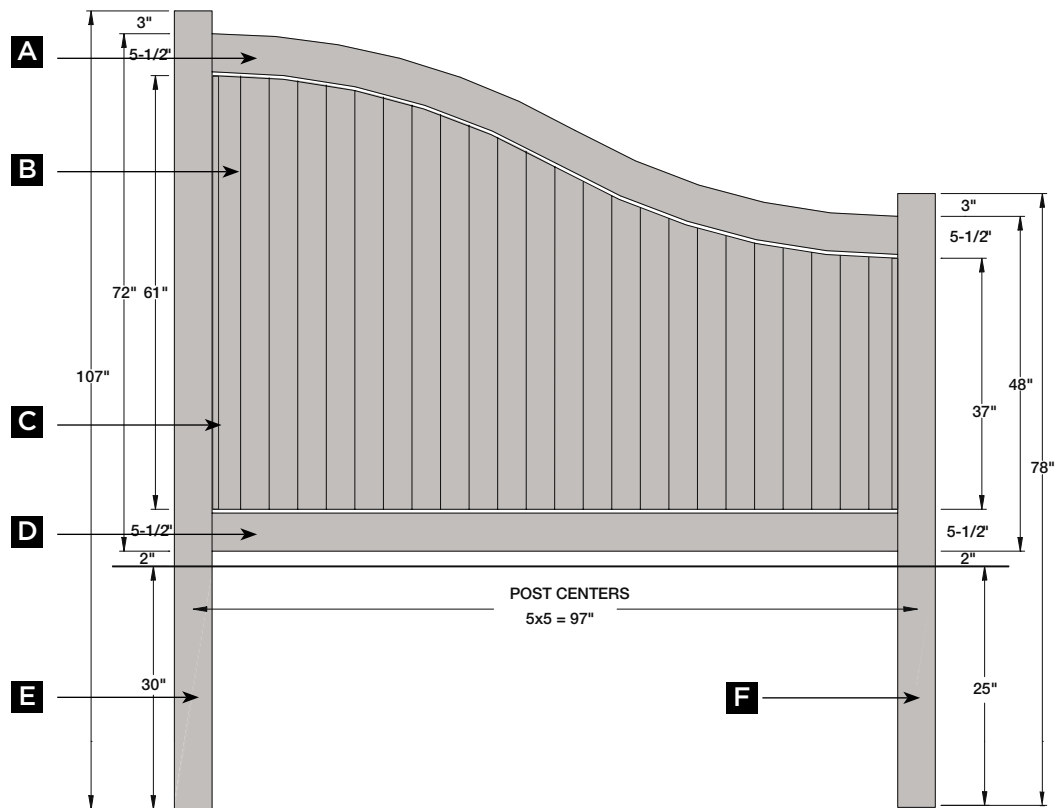

For Almond, add (AL) to item number.

Note: Mixed color sections must be ordered as components; pricing will be higher than standard sections.

QUANTITY	PRODUCT NUMBER	DESCRIPTION
FENCE SECTIONS		
_____	218201	New Lexington Fence Section with Swoop Top Rail (6 ft. x 8 ft. with 24 in. drop)
<i>Note: Fence section includes A, B, C, D and section hardware. Post and caps sold separately. Curved rail pre-cut for 8 ft. panel. Pickets must be field cut. Swoop posts are routed special; see top view illustrations.</i>		
5 IN. X 5 IN. POSTS - 6 FT. END		
_____	535501L	Transition Left Corner Post 5 in. x 5 in. x 96 in.
_____	535501R	Transition Right Corner Post 5 in. x 5 in. x 96 in.
_____	535502	Transition Line Post 5 in. x 5 in. x 96 in.
_____	535503	Transition End Post 5 in. x 5 in. x 96 in.
_____	539096	Blank Post 5 in. x 5 in. x 96 in.
5 IN. X 5 IN. POSTS - 4 FT. END		
_____	535414	Corner Post 5 in. x 5 in. x 78 in.
_____	535424	Line Post 5 in. x 5 in. x 78 in.
_____	535434	End Post 5 in. x 5 in. x 78 in.
_____	539078	Blank Post 5 in. x 5 in. x 78 in.
POST CAPS		
_____	70493	Ball Cap 5 in. x 5 in.
_____	70416	Gothic Cap Ext 5 in. x 5 in.
_____	70417	Flat Cap Int 5 in. x 5 in.
_____	70418	Flat Cap Ext 5 in. x 5 in.
_____	70427	New England Cap Ext 5 in. x 5 in.
OPTIONAL/EXTRA MATERIAL		
_____	70093F	Steel Reinforcement Channel x 90-3/4 in. for 1-1/2 in. x 5-1/2 in. Rail
_____	629301	1-1/2 in. x 5-1/2 in. x 108 in. Deco Swoop Rail
_____	629295	New Lexington 1-1/2 in. x 5-1/2 in. x 95 in. Deco Bottom Rail with Steel
_____	60783P	Lock Rings (order 2 per rail) Qty: 24
_____	479063F	New Lexington Fence Fill Kit 5/8 in. x 11-3/8 in. x 63-3/4 in. Tongue and Groove (8 pc)
_____	71414	2 in. EZ Set Post Brackets (pair with hardware - optional)
_____	17961	End Channel 5/8 in. x 1 in. x 60-7/8 in.

Note: End channels must be attached to posts. Pickets require field cutting.

- A TOP RAIL**
1-1/2" x 5-1/2" x 108"
Swoop Deco rail ribbed.
- B PICKETS**
Section includes 8 pickets of
5/8" x 11-3/8" x 63-3/4"
- C END CHANNEL**
SUPPLIED: 5/8" x 1" x 60-7/8"
FIELD CUT: 5/8" x 1" x 60"
- D BOTTOM RAIL**
1-1/2" x 5-1/2" x 95"
Deco rail ribbed.
Includes steel channel.
- E POST**
5" x 5" x 96"
- F POST**
5" x 5" x 78"

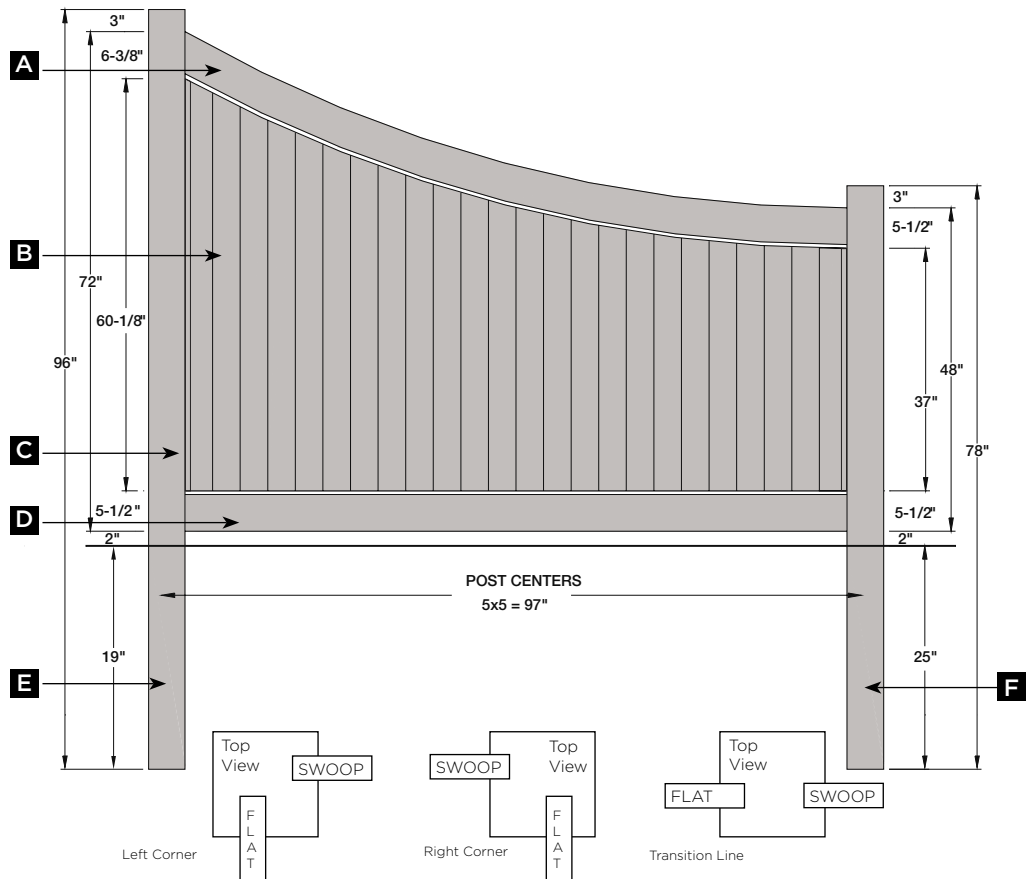

For Almond, add (AL) to item number.

Note: Mixed color sections must be ordered as components; pricing will be higher than standard sections.

QUANTITY	PRODUCT NUMBER	DESCRIPTION
FENCE SECTIONS		
_____	218014	New Lexington Fence Section with Lattice Accent (6 ft. x 8 ft.)
<i>Note: Fence section includes A, B, C, D, E, F and section hardware. Post and caps sold separately.</i>		
5 IN. X 5 IN. POSTS		
_____	536114	Corner Post 5 in. x 5 in. x 107 in.
_____	536124	Line Post 5 in. x 5 in. x 107 in.
_____	536134	End Post 5 in. x 5 in. x 107 in.
_____	539108	Blank Post 5 in. x 5 in. x 107 in.
_____	71106	Aluminum 5 in. x 5 in. x 106 in. Line Post Stiffener
POST CAPS		
_____	70493	Ball Cap 5 in. x 5 in.
_____	70416	Gothic Cap Ext 5 in. x 5 in.
_____	70417	Flat Cap Int 5 in. x 5 in.
_____	70418	Flat Cap Ext 5 in. x 5 in.
_____	70427	New England Cap Ext 5 in. x 5 in.
GATES (hardware ordered separately)		
_____	42742	New Lexington Gate Kit with Accent (builds up to 42-1/2 in. wide gate)
_____	70033F	New Lexington Gate Extension Kit (builds up to 72 in. gate) gate kit must also be ordered
_____	437080	New Lexington Preassembled Gate with Lattice 42-1/2 in. Wide
_____	457080	New Lexington Preassembled Gate with Lattice 50-1/2 in. Wide
_____	447080	New Lexington Preassembled Gate with Lattice 65-1/4 in. Wide
_____	70095	Aluminum 5 in. x 5 in. x 94 in. Gate Post Stiffener
_____	70106	Aluminum 5 in. x 5 in. x 106 in. Gate Post Stiffener
_____	27635	Drop Pin Kit
_____	27742	5 ft. to 6 ft. Height Gate Hardware (self-closing hinges and latch)
_____	27745	Deluxe Key Entry Nylon Gate Hardware (5 ft. and 6 ft. height fence)
_____	27752	Plus Key Entry Nylon Gate Hardware (5 ft. and 6 ft. height fence)
_____	27747	LokkLatch Magnetic Gate Hardware (5 ft. and 6 ft. height fence)
_____	27731	Standard Stainless Steel Gate Hardware Pebble Black Finish
<i>Note: Gate kits include (2) 2-1/2 in. x 4 in. up-rights, caps and screws. Rails and pickets ordered separately.</i>		
OPTIONAL/EXTRA MATERIAL		
_____	70093F	Steel Reinforcement Channel x 90-3/4 in. for 1-1/2 in. x 5-1/2 in. Rail
_____	629293	New Lexington 1-1/2 in. x 5-1/2 in. x 95 in. Deco Top Rail for Lattice
_____	629295	New Lexington 1-1/2 in. x 5-1/2 in. x 95 in. Deco Bottom Rail with Steel
_____	60783P	Lock Rings (order 2 per rail) Qty: 24
_____	479050F	New Lexington Fence Fill Kit 5/8 in. x 11-3/8 in. x 50-3/4 in. Tongue and Groove (8 pc)
_____	71414	2 in. EZ Set Post Brackets (pair with hardware - optional)
_____	444132	New Lexington Lattice Panel 15 in. x 91 in.
_____	37495	1-1/2 in. x 1-1/2 in. x 94-1/2 in. Accent Rail
_____	17961	End Channel 5/8 in. x 1 in. x 60-7/8 in.

Note: End channels must be attached to post.

A TOP ACCENT RAIL
 PALLET QUANTITY = 378
 1-1/2" x 1-1/2" x 94-1/2"

B LATTICE PANEL
 1 piece of 15" x 91-7/8"

C TOP RAIL
 PALLET QUANTITY = 96
 1-1/2" x 5-1/2" x 95"
 Deco rail ribbed.

D PICKETS
 PALLET QUANTITY = 16 fill kits
 Section includes 8 pickets of
 5/8" x 11-3/8" x 50-3/4"

E END CHANNEL
 Supplied: 5/8" x 1" x 60-7/8"
 Field cut: 5/8" x 1" x 47-7/8"

F BOTTOM RAIL
 PALLET QUANTITY = 96
 1-1/2" x 5-1/2" x 95"
 Deco rail ribbed.
 Includes steel channel.

G POST
 PALLET QUANTITY = 48
 5" x 5" x 107"

Racks up to 7 degrees*
***Accents will reduce the degree of rack**

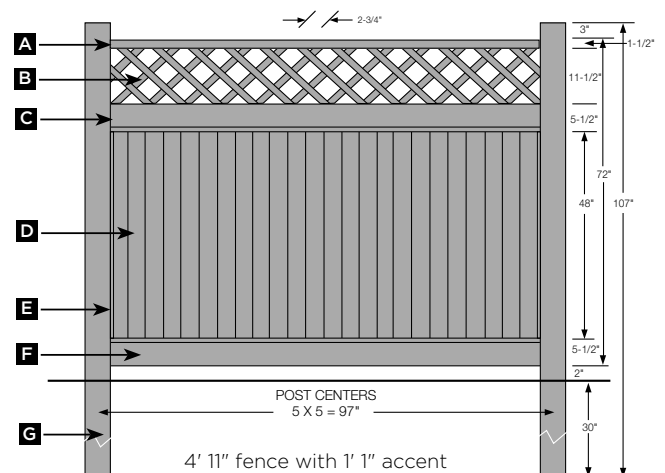

For Almond, add AL to item number.

Note: Mixed color sections must be ordered as components; pricing will be higher than standard sections.

QUANTITY	PRODUCT NUMBER	DESCRIPTION
FENCE SECTIONS		
_____	218010	New Lexington Fence Section with Victorian Accent (6 ft. x 8 ft.)
<i>Note: Fence section includes A, B, C, D, E, F and section hardware. Post and caps sold separately.</i>		
5 IN. X 5 IN. POSTS		
_____	536114	Corner Post 5 in. x 5 in. x 107 in.
_____	536124	Line Post 5 in. x 5 in. x 107 in.
_____	536134	End Post 5 in. x 5 in. x 107 in.
_____	539108	Blank Post 5 in. x 5 in. x 107 in.
_____	71106	Aluminum 5 in. x 5 in. x 106 in. Line Post Stiffener
POST CAPS		
_____	70493	Ball Cap 5 in. x 5 in.
_____	70416	Gothic Cap Ext 5 in. x 5 in.
_____	70417	Flat Cap Int 5 in. x 5 in.
_____	70418	Flat Cap Ext 5 in. x 5 in.
_____	70427	New England Cap Ext 5 in. x 5 in.
GATES (hardware ordered separately)		
_____	42742	New Lexington Gate Kit with Accent (builds up to 42-1/2 in. wide gate)
_____	70033F	New Lexington Gate Extension Kit (builds up to 72 in. gate) gate kit must also be ordered
_____	437086	Preassembled Gate with Victorian Accent 42-1/2 in. Wide
_____	457086	Preassembled Gate with Victorian Accent 50-1/2 in. Wide
_____	447086	Preassembled Gate with Victorian Accent 65-1/4 in. Wide
_____	70106	Aluminum 5 in. x 5 in. x 106 in. Gate Post Stiffener
_____	27635	Drop Pin Kit
_____	27742	5 ft. to 6 ft. Height Gate Hardware (self-closing hinges and latch)
_____	27745	Deluxe Key Entry Nylon Gate Hardware (5 ft. and 6 ft. height fence)
_____	27752	Plus Key Entry Nylon Gate Hardware (5 ft. and 6 ft. height fence)
_____	27747	LokkLatch Magnetic Gate Hardware (5 ft. and 6 ft. height fence)
_____	27731	Standard Stainless Steel Gate Hardware Pebble Black Finish
<i>Note: Gate kits include (2) 2-1/2 in. x 4 in. up-rights, caps and screws. Rails and pickets ordered separately.</i>		
OPTIONAL/EXTRA MATERIAL		
_____	70093F	Steel Reinforcement Channel x 90-3/4 in. for 1-1/2 in. x 5-1/2 in. Rail
_____	629096	New Lexington 1-1/2 in. x 5-1/2 in. x 95 in. Deco Top Rail - Victorian Accent
_____	629295	New Lexington 1-1/2 in. x 5-1/2 in. x 95 in. Deco Bottom Rail with Steel
_____	60783P	Lock Rings (order 2 per rail) Qty: 24
_____	479050F	New Lexington Fence Fill Kit 5/8 in. x 11-3/8 in. x 50-3/4 in. Tongue and Groove (8 pc)
_____	319015	7/8 in. x 1-1/2 in. x 14-7/8 in. Accent Picket
_____	37794	1-1/2 in. x 1-1/2 in. x 94-1/2 in. Victorian Accent Rail
_____	71414	2 in. EZ Set Post Brackets (pair with hardware - optional)
_____	17961	End Channel 5/8 in. x 1 in. x 60-7/8 in.

Note: End channels must be attached to posts.

A TOP ACCENT RAIL
PALLET QUANTITY = 378
1-1/2" x 1-1/2" x 94-1/2"

B ACCENT PANEL
17 pieces of
7/8" x 1-1/2" x 14-7/8"

C TOP RAIL
PALLET QUANTITY = 96
1-1/2" x 5-1/2" x 95"
Deco rail ribbed.

D PICKETS PALLET QUANTITY = 16 fill kits
Section includes 8 pickets.
5/8" x 11-3/8" x 50-3/4"

E END CHANNEL
SUPPLIED: 5/8" x 1" x 60-7/8"
FIELD CUT: 5/8" x 1" x 47-7/8"

F BOTTOM RAIL
PALLET QUANTITY = 96
1-1/2" x 5-1/2" x 95"
Deco rail ribbed.
Includes steel channel.

G POST
PALLET QUANTITY = 48
5" x 5" x 107"

Racks up to 7 degrees*
***Accents will reduce the degree of rack**

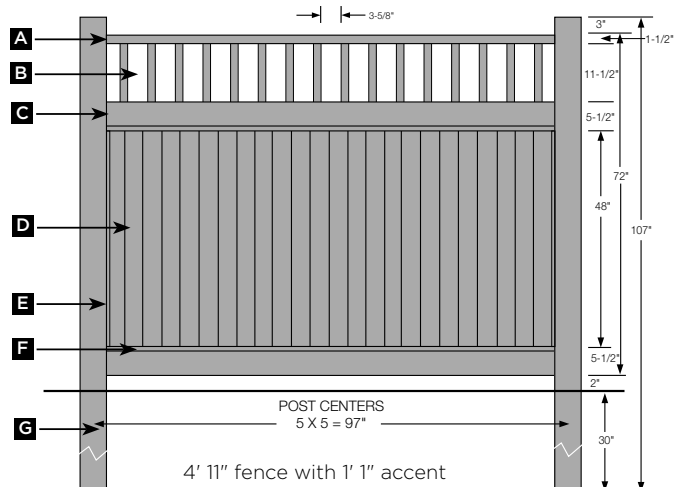

**Semi-Private
Breezewood with Select Cedar
Texture**

4 ft. High / 8 ft. Wide

Select one of the available colors
 ■ Almond ■ Arctic Blend
 ■ Brazilian Blend ■ Clay ■ Sierra Blend
 ■ Weathered Blend ■ White

For colors, add color letters to item number: Almond (AL), Arctic Blend (AC4), Brazilian Blend (BR4), Clay (C), Sierra Blend (SB4), Weathered Blend (WB4).

Note: Mixed color sections must be ordered as components; pricing will be higher than standard sections.

QUANTITY	PRODUCT NUMBER	DESCRIPTION
FENCE SECTIONS		
_____	30204	Select Cedar Breezewood Fence Section (4 ft. x 8 ft.)
<i>Note: Fence section includes A, B, C, D and section hardware. Posts and caps sold separately.</i>		
5 IN. X 5 IN. POSTS		
_____	75741	Textured Corner Post 5 in. x 5 in. x 84 in.
_____	75742	Textured Line Post 5 in. x 5 in. x 84 in.
_____	75743	Textured End Post 5 in. x 5 in. x 84 in.
_____	759084	CertaGrain Blank Post 5 in. x 5 in. x 84 in.
POST CAPS		
_____	70444	CertaGrain Flat Top Cap Ext 5 in. x 5 in.
_____	70459	Textured New England Cap 5 in. x 5 in.
GATES (hardware ordered separately)		
_____	42982	Textured Gate Kit (builds up to 50 in. wide gate)
_____	70031	Gate Extension Kit (builds up to 60 in. gate) gate kit must also be ordered
_____	437094	Breezewood Select Cedar Preassembled Gate 50 in. Wide
_____	70095	Aluminum 5 in. x 5 in. x 94 in. Gate Post Stiffener
_____	27635	Drop Pin Kit
_____	27742	5 ft. to 6 ft. Height Gate Hardware (self-closing hinges and latch)
_____	27745	Deluxe Key Entry Nylon Gate Hardware (5 ft. and 6 ft. height fence)
_____	27752	Plus Key Entry Nylon Gate Hardware (5 ft. and 6 ft. height fence)
_____	27747	LokkLatch Magnetic Gate Hardware (5 ft. and 6 ft. height fence)
_____	27731	Standard Stainless Steel Gate Hardware Pebble Black Finish
<i>Note: Gate kits include (2) 2-1/2 in. x 4 in. up-rights, caps and screws. Rails and pickets ordered separately.</i>		
OPTIONAL/EXTRA MATERIAL		
_____	70090	Steel Reinforcement Channel x 92 in. for 2 in. x 6 in. Rail
_____	809932	Breezewood Select Cedar Top Rail 2 in. x 6 in. x 95 in.
_____	804932	Breezewood Select Cedar Top/Bottom Rail with Steel 2 in. x 6 in. x 95 in.
_____	909542	Breezewood Select Cedar Mid Brace 2 in. x 4 in. x 41-5/32
_____	929596	Select Cedar Picket 7/8 in. x 3 in. x 96 in. Crimped
_____	60783P	Lock Rings (order 2 per rail) Qty: 24

Note: Center brace must to attached to top and bottom rail.

Note: 2" x 4" = 1-3/4" x 3-1/2"

- A TOP RAIL**
 PALLET QUANTITY = 84
 2" x 6" x 95"
 Note: Arctic Blend, Brazilian Blend, Clay, Sierra Blend and Weathered Blend colors include steel in top rail.
- B PICKETS** PALLET QUANTITY = 480
 10 pieces of 7/8" x 3" x 96"
- C MID-BRACE** PALLET QUANTITY = 138
 2" x 4" x 41-5/32"
- D BOTTOM RAIL** PALLET QUANTITY = 84
 2" x 6" x 95"
 Includes steel channel.
- E POST** PALLET QUANTITY = 48
 5" x 5" x 84"

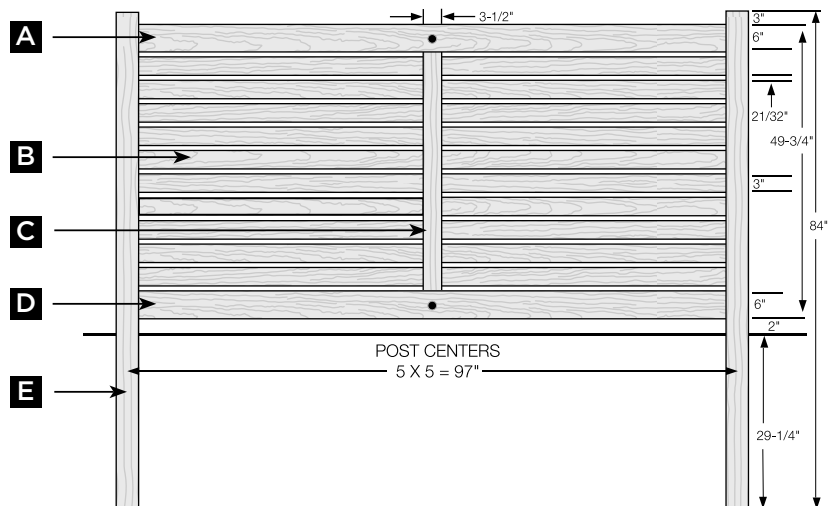

**Semi-Private
Breezewood with Select Cedar
Texture**

5 ft. High / 8 ft. Wide

Select one of the available colors
 ■ Almond ■ Arctic Blend
 ■ Brazilian Blend ■ Clay ■ Sierra Blend
 ■ Weathered Blend ■ White

For colors, add color letters to item number: Almond (AL), Arctic Blend (AC4), Brazilian Blend (BR4), Clay (C), Sierra Blend (SB4), Weathered Blend (WB4).

Note: Mixed color sections must be ordered as components; pricing will be higher than standard sections.

QUANTITY	PRODUCT NUMBER	DESCRIPTION
FENCE SECTIONS		
_____	30205	Select Cedar Breezewood Fence Section (5 ft. x 8 ft.)
<i>Note: Fence section includes A, B, C, D and section hardware. Posts and caps sold separately.</i>		
5 IN. X 5 IN. POSTS		
_____	75751	Textured Corner Post 5 in. x 5 in. x 96 in.
_____	75752	Textured Line Post 5 in. x 5 in. x 96 in.
_____	75753	Textured End Post 5 in. x 5 in. x 96 in.
_____	759096	CertaGrain Blank Post Heavy Wall 5 in. x 5 in. x 96 in.
POST CAPS		
_____	70444	CertaGrain Flat Top Cap Ext 5 in. x 5 in.
_____	70459	Textured New England Cap 5 in. x 5 in.
GATES (hardware ordered separately)		
_____	42983	Textured Gate Kit (builds up to 50 in. wide gate)
_____	70031	Gate Extension Kit (builds up to 60 in. gate) gate kit must also be ordered
_____	437095	Breezewood Select Cedar Preassembled Gate 50 in. Wide
_____	70095	Aluminum 5 in. x 5 in. x 94 in. Gate Post Stiffener
_____	27635	Drop Pin Kit
_____	27742	5 ft. to 6 ft. Height Gate Hardware (self-closing hinges and latch)
_____	27745	Deluxe Key Entry Nylon Gate Hardware (5 ft. and 6 ft. height fence)
_____	27752	Plus Key Entry Nylon Gate Hardware (5 ft. and 6 ft. height fence)
_____	27747	LokkLatch Magnetic Gate Hardware (5 ft. and 6 ft. height fence)
_____	27731	Standard Stainless Steel Gate Hardware Pebble Black Finish
<i>Note: Gate kits include (2) 2-1/2 in. x 4 in. up-rights, caps and screws. Rails and pickets ordered separately.</i>		
OPTIONAL/EXTRA MATERIAL		
_____	70090	Steel Reinforcement Channel x 92 in. for 2 in. x 6 in. Rail
_____	809932	Breezewood Select Cedar Top Rail 2 in. x 6 in. x 95 in.
_____	804932	Breezewood Select Cedar Top/Bottom Rail with Steel 2 in. x 6 in. x 95 in.
_____	909553	Breezewood Select Cedar Mid Brace 2 in. x 4 in. x 52-5/8
_____	929596	Select Cedar Picket 7/8 in. x 3 in. x 96 in. Crimped
_____	60783P	Lock Rings (order 2 per rail) Qty: 24

Note: Center brace must to attached to top and bottom rail.

Note: 2" x 4" = 1-3/4" x 3-1/2"

- A TOP RAIL**
 PALLET QUANTITY = 84
 2" x 6" x 95"
 Note: Arctic Blend, Brazilian Blend, Clay, Sierra Blend and Weathered Blend colors include steel in top rail.
- B PICKETS**
 PALLET QUANTITY = 480
 13 pickets of 7/8" x 3" x 96"
- C MID-BRACE**
 PALLET QUANTITY = 138
 2" x 4" x 52-5/8"
- D BOTTOM RAIL**
 PALLET QUANTITY = 84
 2" x 6" x 95"
 Includes steel channel.
- E POST**
 PALLET QUANTITY = 48
 5" x 5" x 96"

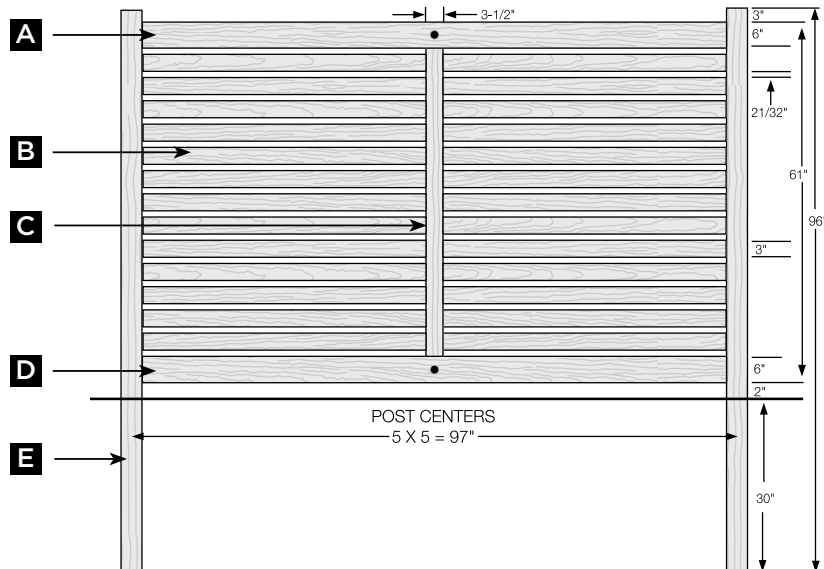

**Semi-Private
Breezewood with Select Cedar
Texture**

6 ft. High / 8 ft. Wide

Select one of the available colors
 ■ Almond ■ Arctic Blend
 ■ Brazilian Blend ■ Clay ■ Sierra Blend
 ■ Weathered Blend ■ White

For colors, add color letters to item number: Almond (AL), Arctic Blend (AC4), Brazilian Blend (BR4), Clay (C), Sierra Blend (SB4), Weathered Blend (WB4).

Note: Mixed color sections must be ordered as components; pricing will be higher than standard sections.

QUANTITY	PRODUCT NUMBER	DESCRIPTION
FENCE SECTIONS		
_____	30206	Select Cedar Breezewood Fence Section (6 ft. x 8 ft.)
<i>Note: Fence section includes A, B, C, D and section hardware. Posts and caps sold separately.</i>		
5 IN. X 5 IN. POSTS		
_____	75761	Textured Corner Post 5 in. x 5 in. x 107 in.
_____	75762	Textured Line Post 5 in. x 5 in. x 107 in.
_____	71106	Aluminum 5 in. x 5 in. x 106 in. Line Post Stiffener
_____	75763	Textured End Post 5 in. x 5 in. x 107 in.
_____	759108	CertaGrain Blank Post Heavy Wall 5 in. x 5 in. x 107 in.
POST CAPS		
_____	70444	CertaGrain Flat Top Cap Ext 5 in. x 5 in.
_____	70459	Textured New England Cap 5 in. x 5 in.
GATES (hardware ordered separately)		
_____	42984	Textured Gate Kit (builds up to 50 in. wide gate)
_____	70031	Gate Extension Kit (builds up to 60 in. gate) gate kit must also be ordered
_____	437096	Breezewood Select Cedar Preassembled Gate 50 in. Wide
_____	70106	Aluminum 5 in. x 5 in. x 106 in. Gate Post Stiffener
_____	27635	Drop Pin Kit
_____	27742	5 ft. to 6 ft. Height Gate Hardware (self-closing hinges and latch)
_____	27745	Deluxe Key Entry Nylon Gate Hardware (5 ft. and 6 ft. height fence)
_____	27752	Plus Key Entry Nylon Gate Hardware (5 ft. and 6 ft. height fence)
_____	27747	LokkLatch Magnetic Gate Hardware (5 ft. and 6 ft. height fence)
_____	27731	Standard Stainless Steel Gate Hardware Pebble Black Finish
<i>Note: Gate kits include (2) 2-1/2 in. x 4 in. up-rights, caps and screws. Rails and pickets ordered separately.</i>		
OPTIONAL/EXTRA MATERIALS		
_____	70090	Steel Reinforcement Channel x 92 in. for 2 in. x 6 in. Rail
_____	809932	Breezewood Select Cedar Top Rail 2 in. x 6 in. x 95 in.
_____	804932	Breezewood Select Cedar Top/Bottom Rail with Steel 2 in. x 6 in. x 95 in.
_____	909564	Breezewood Select Cedar Mid Brace 2 in. x 4 in. x 63-3/8
_____	929596	Select Cedar Picket 7/8 in. x 3 in. x 96 in. Crimped
_____	60783P	Lock Rings (order 2 per rail) Qty: 24
<i>Note: Center brace must to attached to top and bottom rail.</i>		

Note: 2" x 4" = 1-3/4" x 3-1/2"

- A TOP RAIL**
 PALLET QUANTITY = 84
 2" x 6" x 95"
 Note: Arctic Blend, Brazilian Blend, Clay, Sierra Blend and Weathered Blend colors include steel in top rail.
- B PICKETS**
 PALLET QUANTITY = 480
 16 pieces of 7/8" x 3" x 96"
- C MID-BRACE**
 PALLET QUANTITY = 138
 2" x 4" x 63-3/8"
- D BOTTOM RAIL**
 PALLET QUANTITY = 84
 2" x 6" x 95"
 Includes steel channel.
- E POST**
 PALLET QUANTITY = 48
 5" x 5" x 107"



**FEATURING
WINDZONE-
TECHNOLOGY**

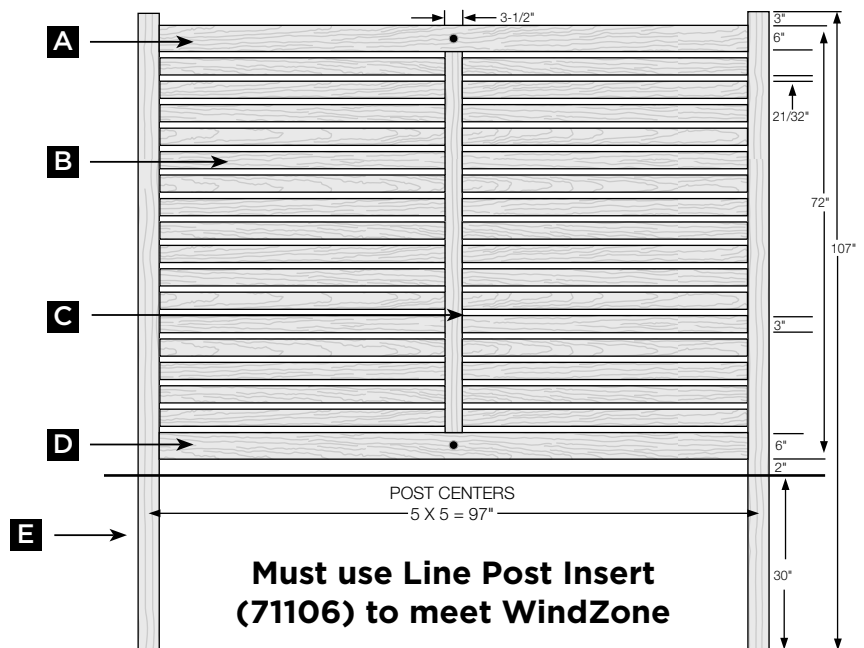

**Must use Line Post Insert
(71106) to meet WindZone**

QUANTITY	PRODUCT NUMBER	DESCRIPTION
FENCE SECTIONS		
_____	205968A	Columbia Fence Section with Aluminum (6 ft. x 8 ft.)
<i>Note: Fence section includes A, B, C, D and section hardware. Post and caps sold separately.</i>		
5 IN. X 5 IN. POSTS		
_____	67771	Columbia Corner Post 5 in. x 5 in. x 107 in.
_____	67772	Columbia Line Post 5 in. x 5 in. x 107 in.
_____	67773	Columbia End Post 5 in. x 5 in. x 107 in.
_____	679108	Blank Post Heavy Wall 5 in. x 5 in. x 107 in.
_____	70148	Aluminum 5 in. x 5 in. x 48 in. Line Post Stiffener Kit (required for WindZone system)
POST CAPS		
_____	70493	Ball Cap 5 in. x 5 in.
_____	70416	Gothic Cap Ext 5 in. x 5 in.
_____	70418	Flat Cap Ext 5 in. x 5 in.
_____	70427	New England Cap Ext 5 in. x 5 in.
GATES (hardware ordered separately)		
_____	42720	Millbrook Gate Kit (builds up to 50 in. wide gate)
_____	70031	Gate Extension Kit (builds up to 60 in. gate) gate kit must also be ordered
_____	204268	Millbrook Fence Section (6 ft. x 8 ft.)
_____	437051	Millbrook Preadsembled Gate 50 in. Wide
_____	70106	Aluminum 5 in. x 5 in. x 106 in. Gate Post Stiffener
_____	27635	Drop Pin Kit
_____	27742	5 ft. to 6 ft. Height Gate Hardware (self-closing hinges and latch)
_____	27745	Deluxe Key Entry Nylon Gate Hardware (5 ft. and 6 ft. height fence)
_____	27752	Plus Key Entry Nylon Gate Hardware (5 ft. and 6 ft. height fence)
_____	27747	LokkLatch Magnetic Gate Hardware (5 ft. and 6 ft. height fence)
_____	27731	Standard Stainless Steel Gate Hardware Pebble Black Finish
<i>Note: Gate kits include (2) 2-1/2 in. x 4 in. up-rights caps, and screws. Rails and pickets ordered separately (use Millbrook Fence Section).</i>		
OPTIONAL/EXTRA MATERIAL		
_____	70192	Aluminum Reinforcement Channel x 92 in. for 3-1/2 in. Square Rail
_____	286118	Columbia 3-1/2 in. x 3-1/2 in. x 94-1/2 in. Routed Top Rail
_____	286138	Columbia 3-1/2 in. x 3-1/2 in. x 94-1/2 in. Routed Bottom Rail with Aluminum
_____	286158	Columbia 3-1/2 in. x 3-1/2 in. x 94-1/2 in. Routed Mid Rail
_____	359071	Picket 7/8 in. x 6 in. x 71-1/2 in. Ribbed
_____	70798P	Bullet Clips Qty: 100
_____	71414	2 in. EZ Set Post Brackets (pair with hardware - optional)

- A TOP RAIL** PALLET QUANTITY = 84
3-1/2" x 3-1/2" x 94-1/2"
- B PICKETS** PALLET QUANTITY = 196
17 pieces of 7/8" x 6" x 71-1/2" ribbed.
- C MID RAIL** PALLET QUANTITY = 84
3-1/2" x 3-1/2" x 94-1/2"
- D BOTTOM RAIL** PALLET QUANTITY = 84
3-1/2" x 3-1/2" x 94-1/2"
Includes aluminum reinforcement channel.
- E POST** PALLET QUANTITY = 48
5" x 5" x 107"

Racks up to 5 degrees



**FEATURING
WINDZONE[™]
TECHNOLOGY**

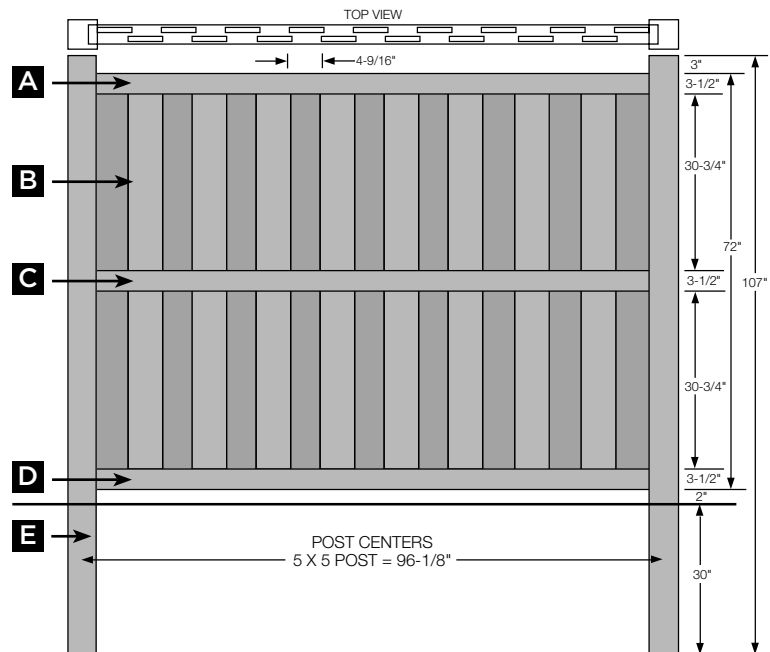

For colors, add color letters to item number: Almond (AL), Clay (C).

Note: Mixed color sections must be ordered as components; pricing will be higher than standard sections.

QUANTITY	PRODUCT NUMBER	DESCRIPTION
FENCE SECTIONS		
_____	204148	Imperial Fence Section (4 ft. x 8 ft.)
<i>Note: Fence section includes A, B, C and section hardware. Post and caps sold separately.</i>		
4 IN. X 4 IN. POSTS		
_____	64471	Corner Post 4 in. x 4 in. x 84 in.
_____	64472	Line Post 4 in. x 4 in. x 84 in.
_____	64473	End Post 4 in. x 4 in. x 84 in.
_____	649084	Blank Post 4 in. x 4 in. x 84 in.
POST CAPS		
_____	70409	Gothic Cap Ext 4 in. x 4 in.
_____	70492	Ball Cap 4 in. x 4 in.
_____	70411	Flat Cap Int 4 in. x 4 in.
_____	70414	Flat Cap Ext 4 in. x 4 in.
_____	70426	New England Cap 4 in. x 4 in.
GATES (hardware ordered separately)		
_____	42716	Gate Kit (builds up to 50 in. wide gate)
_____	70029	Gate Extension Kit (builds to 72 in. wide gate) gate kit must also be ordered
_____	437037	Preassembled Gate 50 in. Wide
_____	27630	MagnaLatch
_____	70082	Aluminum 4 in. x 4 in. x 82 in. Gate Post Stiffener
_____	27635	Drop Pin Kit
_____	27741	3 ft. to 4 ft. Height Gate Hardware (self-closing hinges and latch)
_____	27744	Deluxe Key Entry Nylon Gate Hardware (3 ft. and 4 ft. height fence)
_____	27751	Plus Key Entry Nylon Gate Hardware (3 ft. and 4 ft. height fence)
_____	27731	Standard Stainless Steel Gate Hardware Pebble Black Finish
<i>Note: Gate kits include (2) 2-1/2 in. x 4 in. up-rights, caps and screws. Rails and pickets ordered separately.</i>		
OPTIONAL/EXTRA MATERIAL		
_____	70292	Aluminum Reinforcement Channel x 92 in. or 2 in. x 4 in. (optional)
_____	70092	Steel Reinforcement Channel x 92 in. for 2 in. x 4 in. (required for top rail of WindZone system)
_____	284018	Imperial 2 in. x 4 in. x 95-1/2 in. Routed Top Rail
_____	284038	Imperial 2 in. x 4 in. x 95-1/2 in. Routed Bottom Rail with Steel
_____	349048	Picket 7/8 in. x 3 in. x 48 in.
_____	71413	1-5/8 in. EZ Set Post Brackets (pair with hardware - optional)

Note: 2" x 4" = 1-3/4" x 3-1/2"

- A TOP RAIL** PALLET QUANTITY = 138
2" x 4" x 95-1/2"
Clay top rail includes steel reinforcement channel.
- B PICKETS** PALLET QUANTITY = 480
26 pieces of 7/8" x 3" x 48"
- C BOTTOM RAIL**
PALLET QUANTITY = 138
2" x 4" x 95-1/2"
Includes steel reinforcement channel.
- D POST** PALLET QUANTITY = 60
4" x 4" x 84"

Racks up to 10 degrees



**MEETS
POOL
CODE**

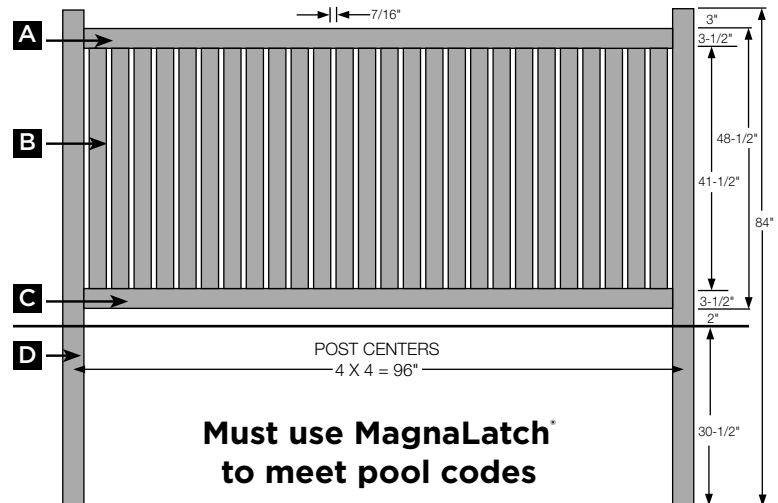

For colors, add color letters to item number: Almond (AL), Clay (C).

Note: Mixed color sections must be ordered as components; pricing will be higher than standard sections.

QUANTITY	PRODUCT NUMBER	DESCRIPTION
FENCE SECTIONS		
_____	204158	Imperial Fence Section (5 ft. x 8 ft.)

Note: Fence section includes A, B, C, D and section hardware. Post and caps sold separately.

5 IN. X 5 IN. POSTS		
_____	52111	Corner Post 5 in. x 5 in. x 96 in.
_____	52112	Line Post 5 in. x 5 in. x 96 in.
_____	52113	End Post 5 in. x 5 in. x 96 in.
_____	539096	Blank Post 5 in. x 5 in. x 96 in.

POST CAPS		
_____	70493	Ball Cap 5 in. x 5 in.
_____	70416	Gothic Cap Ext 5 in. x 5 in.
_____	70417	Flat Cap Int 5 in. x 5 in.
_____	70418	Flat Cap Ext 5 in. x 5 in.
_____	70427	New England Cap Ext 5 in. x 5 in.

GATES (hardware ordered separately)		
_____	42717	Gate Kit (builds up to 50 in. wide gate)
_____	70029	Gate Extension Kit (builds to 72 in. wide gate) gate kit must also be ordered
_____	437043	Preassembled Gate 50 in. Wide
_____	70095	Aluminum 5 in. x 5 in. x 94 in. Gate Post Stiffener
_____	27635	Drop Pin Kit
_____	27742	5 ft. to 6 ft. Height Gate Hardware (self-closing hinges and latch)
_____	27745	Deluxe Key Entry Nylon Gate Hardware (5 ft. and 6 ft. height fence)
_____	27752	Plus Key Entry Nylon Gate Hardware (5 ft. and 6 ft. height fence)
_____	27747	LokkLatch Magnetic Gate Hardware (5 ft. and 6 ft. height fence)
_____	27731	Standard Stainless Steel Gate Hardware Pebble Black Finish

Note: Gate kits include (2) 2-1/2 in. x 4 in. up-rights, caps, and screws. Rails and pickets ordered separately.

OPTIONAL/EXTRA MATERIAL		
_____	70292	Aluminum Reinforcement Channel x 92 in. or 2 in. x 4 in. (optional)
_____	70092	Steel Reinforcement Channel x 92 in. for 2 in. x 4 in. (required for top rail of WindZone system)
_____	284018	Imperial 2 in. x 4 in. x 95-1/2 in. Routed Top Rail
_____	284038	Imperial 2 in. x 4 in. x 95-1/2 in. Routed Bottom Rail with Steel
_____	284118	Imperial 2 in. x 4 in. x 95-1/2 in. Routed Mid Rail
_____	349060	Picket 7/8 in. x 3 in. x 59-5/8 in.
_____	71414	2 in. EZ Set Post Brackets (pair with hardware - optional)

Note: Attach Mid Rail with supplied hardware.

Note: 2" x 4" = 1-3/4" x 3-1/2"

- A TOP RAIL** PALLET QUANTITY = 138
2" x 4" x 95-1/2"
Clay top rail includes steel reinforcement channel.
- B MID RAIL** PALLET QUANTITY = 138
2" x 4" x 95-1/2"
- C PICKETS** PALLET QUANTITY = 480
26 pieces of 7/8" x 3" x 59-5/8"
- D BOTTOM RAIL**
PALLET QUANTITY = 138
2" x 4" x 95-1/2"
Includes steel reinforcement channel.
- E POST** PALLET QUANTITY = 48
5" x 5" x 96"

Racks up to 5 degrees



**MEETS
POOL
CODE**

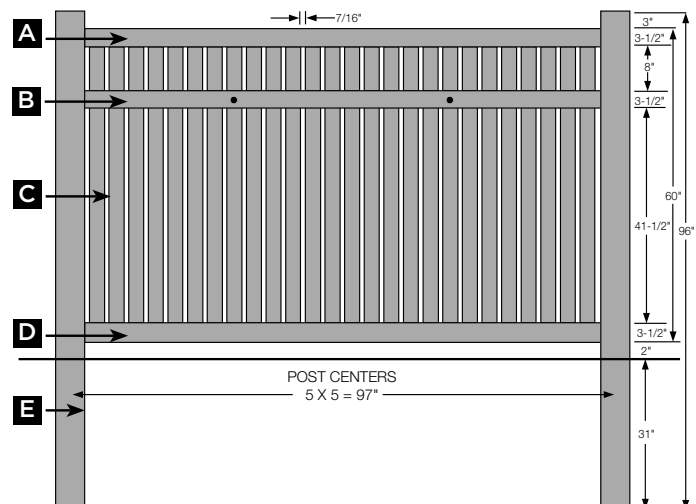

For colors, add color letters to item number: Almond (AL), Clay (C).

Note: Mixed color sections must be ordered as components; pricing will be higher than standard sections.

QUANTITY	PRODUCT NUMBER	DESCRIPTION
FENCE SECTIONS		
_____	204168	Imperial Fence Section (6 ft. x 8 ft.)

Note: Fence section includes A, B, C, D and section hardware. Post and caps sold separately.

5 IN. X 5 IN. POSTS		
_____	67491	Corner Post 5 in. x 5 in. x 107 in.
_____	67492	Line Post 5 in. x 5 in. x 107 in.
_____	67493	End Post 5 in. x 5 in. x 107 in.
_____	679108	Blank Post Heavy Wall 5 in. x 5 in. x 107 in.
_____	70148	Aluminum 5 in. x 5 in. x 48 in. Line Post Stiffener Kit (required for WindZone system)

POST CAPS		
_____	70493	Ball Cap 5 in. x 5 in.
_____	70416	Gothic Cap Ext 5 in. x 5 in.
_____	70418	Flat Cap Ext 5 in. x 5 in.
_____	70427	New England Cap Ext 5 in. x 5 in.

GATES (hardware ordered separately)		
_____	42718	Gate Kit (builds up to 50 in. wide gate)
_____	70029	Gate Extension Kit (builds to 72 in. wide gate) gate kit must also be ordered
_____	437049	Preassembled Gate 50 in. Wide
_____	70106	Aluminum 5 in. x 5 in. x 106 in. Gate Post Stiffener
_____	27635	Drop Pin Kit
_____	27742	5 ft. to 6 ft. Height Gate Hardware (self-closing hinges and latch)
_____	27745	Deluxe Key Entry Nylon Gate Hardware (5 ft. and 6 ft. height fence)
_____	27752	Plus Key Entry Nylon Gate Hardware (5 ft. and 6 ft. height fence)
_____	27747	LokkLatch Magnetic Gate Hardware (5 ft. and 6 ft. height fence)
_____	27731	Standard Stainless Steel Gate Hardware Pebble Black Finish

Note: Gate kits include (2) 2-1/2 in. x 4 in. up-rights, caps and screws. Rails and pickets ordered separately.

OPTIONAL/EXTRA MATERIAL		
_____	70292	Aluminum Reinforcement Channel x 92 in. or 2 in. x 4 in. (optional)
_____	70092	Steel Reinforcement Channel x 92 in. for 2 in. x 4 in. (required for top rail of WindZone system)
_____	284018	Imperial 2 in. x 4 in. x 95-1/2 in. Routed Top Rail
_____	284038	Imperial 2 in. x 4 in. x 95-1/2 in. Routed Bottom Rail with Steel
_____	284118	Imperial 2 in. x 4 in. x 95-1/2 in. Routed Mid Rail
_____	349072	Picket 7/8 in. x 3 in. x 71-5/8 in.
_____	71414	2 in. EZ Set Post Brackets (pair with hardware - optional)

Note: Attach Mid Rail with supplied hardware.

Note: 2" x 4" = 1-3/4" x 3-1/2"

- A TOP RAIL** PALLET QUANTITY = 138
2" x 4" x 95-1/2"
Clay top rail includes steel reinforcement channel.
- B MID RAIL** PALLET QUANTITY = 138
2" x 4" x 95-1/2"
- C PICKETS** PALLET QUANTITY = 480
26 pieces of 7/8" x 3" x 71-5/8"
- D BOTTOM RAIL** PALLET QUANTITY = 138
2" x 4" x 95-1/2"
Includes steel reinforcement channel.
- E POST** PALLET QUANTITY = 48
5" x 5" x 107"

Racks up to 5 degrees



**FEATURING
WINDZONE-
TECHNOLOGY**



**MEETS
POOL
CODE**

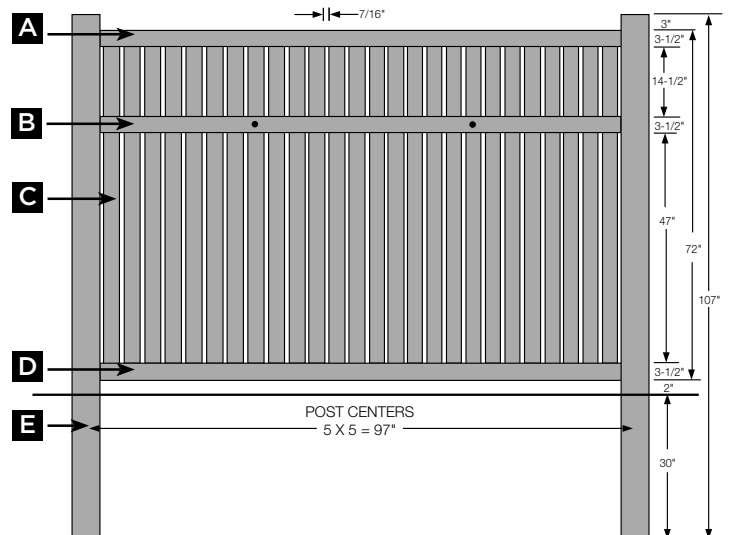

**Semi-Private
Imperial with Select Cedar
Texture**

4 ft. High / 8 ft. Wide

- Select one of the available colors**
- Almond ■ Arbor Blend ■ Arctic Blend
 - Brazilian Blend ■ Clay
 - Frontier Blend ■ Sierra Blend
 - Timber Blend ■ Weathered Blend
 - White

For colors, add color letters to item number: Almond (AL), Arbor Blend (AR4), Arctic Blend (AC4), Brazilian Blend (BR4), Clay (C), Frontier Blend (FB4), Sierra Blend (SB4), Timber Blend (TB4), Weathered Blend (WB4). Note: Mixed color sections must be ordered as components; pricing will be higher than standard sections.

QUANTITY	PRODUCT NUMBER	DESCRIPTION
FENCE SECTIONS		
_____	30414	Imperial with Select Cedar Texture Fence Section (4 ft. x 8 ft.)
<i>Note: Fence section includes A, B, C and section hardware. Post and caps sold separately.</i>		
5 IN. X 5 IN. POSTS		
_____	75721	Textured Corner Post 5 in. x 5 in. x 84 in.
_____	75722	Textured Line Post 5 in. x 5 in. x 84 in.
_____	75723	Textured End Post 5 in. x 5 in. x 84 in.
_____	759084	CertaGrain Blank Post 5 in. x 5 in. x 84 in.
POST CAPS		
_____	70444	CertaGrain Flat Top Cap Ext 5 in. x 5 in.
_____	70459	Textured New England Cap 5 in. x 5 in.
GATES (hardware ordered separately)		
_____	42739	Textured Gate Kit (builds up to 50 in. wide gate)
_____	70029	Gate Extension Kit (builds to 72 in. wide gate) gate kit must also be ordered
_____	437077	Select Cedar Preassembled Gate 50 in. Wide
_____	27630	MagnaLatch
_____	70095	Aluminum 5 in. x 5 in. x 94 in. Gate Post Stiffener
_____	27635	Drop Pin Kit
_____	27742	5 ft. to 6 ft. Height Gate Hardware (self-closing hinges and latch)
_____	27745	Deluxe Key Entry Nylon Gate Hardware (5 ft. and 6 ft. height fence)
_____	27752	Plus Key Entry Nylon Gate Hardware (5 ft. and 6 ft. height fence)
_____	27747	LokkLatch Magnetic Gate Hardware (5 ft. and 6 ft. height fence)
_____	27731	Standard Stainless Steel Gate Hardware Pebble Black Finish
<i>Note: Gate kits include (2) 2-1/2 in. x 4 in. up-rights, caps, and screws. Rails and pickets ordered separately.</i>		
OPTIONAL/EXTRA MATERIAL		
_____	70292	Aluminum Reinforcement Channel x 92 in. or 2 in. x 4 in. (optional)
_____	70092	Steel Reinforcement Channel x 92 in. for 2 in. x 4 in. (required for top rail of WindZone system)
_____	906011	Imperial Select Cedar 2 in. x 4 in. x 95-1/2 in. Routed Top Rail
_____	906012	Imperial Select Cedar 2 in. x 4 in. x 95-1/2 in. Routed Bottom Rail with Steel
_____	929048	Select Cedar Picket 7/8 in. x 3 in. x 48 in.
_____	71414	2 in. EZ Set Post Brackets (pair with hardware - optional)

Note: 2" x 4" = 1-3/4" x 3-1/2"

- A TOP RAIL** PALLET QUANTITY = 138
2" x 4" x 95-1/2"
Note: Arbor Blend, Arctic Blend, Brazilian Blend, Clay, Frontier Blend, Sierra Blend, Timber Blend and Weathered Blend colors include steel in top rail.
- B PICKETS** PALLET QUANTITY = 480
26 pieces of 7/8" x 3" x 48"
- C BOTTOM RAIL**
PALLET QUANTITY = 138
2" x 4" x 95-1/2"
Includes steel reinforcement channel.
- D POST** PALLET QUANTITY = 48
5" x 5" x 84"

Racks up to 10 degrees



**MEETS
POOL
CODE**

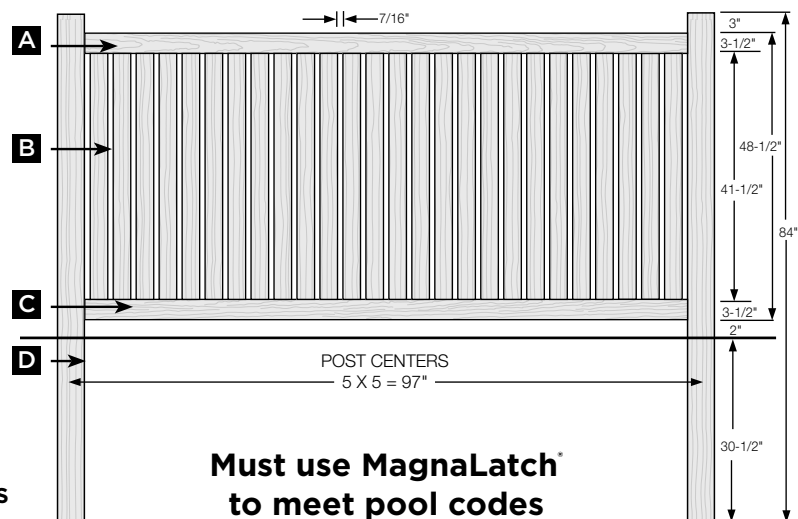

**Semi-Private
Imperial with Select Cedar
Texture**

5 ft. High / 8 ft. Wide

Select one of the available colors

- Almond ■ Arbor Blend ■ Arctic Blend
- Brazilian Blend ■ Clay
- Frontier Blend ■ Sierra Blend
- Timber Blend ■ Weathered Blend
- White

For colors, add color letters to item number: Almond (AL), Arbor Blend (AR4), Arctic Blend (AC4), Brazilian Blend (BR4), Clay (C), Frontier Blend (FB4), Sierra Blend (SB4), Timber Blend (TB4), Weathered Blend (WB4). Note: Mixed color sections must be ordered as components; pricing will be higher than standard sections.

QUANTITY	PRODUCT NUMBER	DESCRIPTION
FENCE SECTIONS		
_____	30415	Imperial with Select Cedar Texture Fence Section (5 ft. x 8 ft.)
<i>Note: Fence section includes A, B, C, D and section hardware. Posts and caps sold separately.</i>		
5 IN. X 5 IN. POSTS		
_____	75701	Textured Corner Post 5 in. x 5 in. x 96 in.
_____	75702	Textured Line Post 5 in. x 5 in. x 96 in.
_____	75703	Textured End Post 5 in. x 5 in. x 96 in.
_____	759096	CertaGrain Blank Post Heavy Wall 5 in. x 5 in. x 96 in.
POST CAPS		
_____	70444	CertaGrain Flat Top Cap Ext 5 in. x 5 in.
_____	70459	Textured New England Cap 5 in. x 5 in.
GATES (hardware ordered separately)		
_____	42740	Textured Gate Kit (builds up to 50 in. wide gate)
_____	70029	Gate Extension Kit (builds to 72 in. wide gate) gate kit must also be ordered
_____	437078	Select Cedar Preassembled Gate 50 in. Wide
_____	70095	Aluminum 5 in. x 5 in. x 94 in. Gate Post Stiffener
_____	27635	Drop Pin Kit
_____	27742	5 ft. to 6 ft. Height Gate Hardware (self-closing hinges and latch)
_____	27745	Deluxe Key Entry Nylon Gate Hardware (5 ft. and 6 ft. height fence)
_____	27752	Plus Key Entry Nylon Gate Hardware (5 ft. and 6 ft. height fence)
_____	27747	LokkLatch Magnetic Gate Hardware (5 ft. and 6 ft. height fence)
_____	27731	Standard Stainless Steel Gate Hardware Pebble Black Finish
<i>Note: Gate kits include (2) 2-1/2 in. x 4 in. up-rights, caps and screws. Rails and pickets ordered separately.</i>		
OPTIONAL/EXTRA MATERIAL		
_____	70292	Aluminum Reinforcement Channel x 92 in. or 2 in. x 4 in. (optional)
_____	70092	Steel Reinforcement Channel x 92 in. for 2 in. x 4 in. (required for top rail of WindZone system)
_____	906011	Imperial Select Cedar 2 in. x 4 in. x 95-1/2 in. Routed Top Rail
_____	906012	Imperial Select Cedar 2 in. x 4 in. x 95-1/2 in. Routed Bottom Rail with Steel
_____	906013	Imperial Select Cedar 2 in. x 4 in. x 95-1/2 in. Routed Mid Rail
_____	929060	Select Cedar Picket 7/8 in. x 3 in. x 59-5/8 in.
_____	71414	2 in. EZ Set Post Brackets (pair with hardware - optional)

Note: Attach Mid Rail with supplied hardware.

- A TOP RAIL** PALLET QUANTITY = 138
2" x 4" x 95-1/2"
Note: Arbor Blend, Arctic Blend, Brazilian Blend, Clay, Frontier Blend, Sierra Blend, Timber Blend and Weathered Blend colors include steel in top rail.
- B MID RAIL** PALLET QUANTITY = 138
2" x 4" x 95-1/2"
- C PICKETS** PALLET QUANTITY = 480
26 pieces of 7/8" x 3" x 59-5/8"
- D BOTTOM RAIL**
PALLET QUANTITY = 138
2" x 4" x 95-1/2"
Includes steel reinforcement channel.
- E POST** PALLET QUANTITY = 48
5" x 5" x 96"

Racks up to 5 degrees



**MEETS
POOL
CODE**

Note: 2" x 4" = 1-3/4" x 3-1/2"

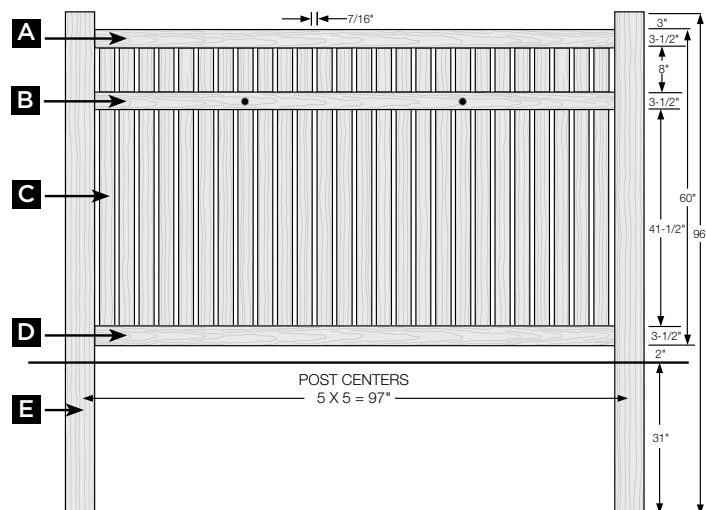

**Semi-Private
Imperial with Select Cedar
Texture**

6 ft. High / 8 ft. Wide

- Select one of the available colors**
 ■ Almond ■ Arbor Blend ■ Arctic Blend
 ■ Brazilian Blend ■ Clay
 ■ Frontier Blend ■ Sierra Blend
 ■ Timber Blend ■ Weathered Blend
 ■ White

For colors, add color letters to item number: Almond (AL), Arbor Blend (AR4), Arctic Blend (AC4), Brazilian Blend (BR4), Clay (C), Frontier Blend (FB4), Sierra Blend (SB4), Timber Blend (TB4), Weathered Blend (WB4). Note: Mixed color sections must be ordered as components; pricing will be higher than standard sections.

QUANTITY	PRODUCT NUMBER	DESCRIPTION
FENCE SECTIONS		
_____	30416	Imperial with Select Cedar Texture Fence Section (6 ft. x 8 ft.)
<i>Note: Fence section includes A, B, C, D and section hardware. Post and caps sold separately.</i>		
5 IN. X 5 IN. POSTS		
_____	75711	Textured Corner Post 5 in. x 5 in. x 107 in.
_____	75712	Textured Line Post 5 in. x 5 in. x 107 in.
_____	75713	Textured End Post 5 in. x 5 in. x 107 in.
_____	759108	CertaGrain Blank Post Heavy Wall 5 in. x 5 in. x 107 in.
_____	70148	Aluminum 5 in. x 5 in. x 48 in. Line Post Stiffener Kit (required for WindZone system)
POST CAPS		
_____	70444	CertaGrain Flat Top Cap Ext 5 in. x 5 in.
_____	70459	Textured New England Cap 5 in. x 5 in.
GATES (hardware ordered separately)		
_____	42741	Textured Gate Kit (builds up to 50 in. wide gate)
_____	70029	Gate Extension Kit (builds to 72 in. wide gate) gate kit must also be ordered
_____	437079	Select Cedar Preassembled Gate 50 in. Wide
_____	70106	Aluminum 5 in. x 5 in. x 106 in. Gate Post Stiffener
_____	27635	Drop Pin Kit
_____	27742	5 ft. to 6 ft. Height Gate Hardware (self-closing hinges and latch)
_____	27745	Deluxe Key Entry Nylon Gate Hardware (5 ft. and 6 ft. height fence)
_____	27752	Plus Key Entry Nylon Gate Hardware (5 ft. and 6 ft. height fence)
_____	27747	LokkLatch Magnetic Gate Hardware (5 ft. and 6 ft. height fence)
_____	27731	Standard Stainless Steel Gate Hardware Pebble Black Finish
<i>Note: Gate kits include (2) 2-1/2 in. x 4 in. up-rights, caps and screws. Rails and pickets ordered separately.</i>		
OPTIONAL/EXTRA MATERIAL		
_____	70292	Aluminum Reinforcement Channel x 92 in. or 2 in. x 4 in. (optional)
_____	70092	Steel Reinforcement Channel x 92 in. for 2 in. x 4 in. (required for top rail of WindZone system)
_____	906011	Imperial Select Cedar 2 in. x 4 in. x 95-1/2 in. Routed Top Rail
_____	906012	Imperial Select Cedar 2 in. x 4 in. x 95-1/2 in. Routed Bottom Rail with Steel
_____	906013	Imperial Select Cedar 2 in. x 4 in. x 95-1/2 in. Routed Mid Rail
_____	929072	Select Cedar Picket 7/8 in. x 3 in. x 71-5/8 in.
_____	71414	2 in. EZ Set Post Brackets (pair with hardware - optional)

Note: Attach Mid Rail with supplied hardware.

- A TOP RAIL** PALLET QUANTITY = 138
2" x 4" x 95-1/2"
Note: Arbor Blend, Arctic Blend, Brazilian Blend, Clay, Frontier Blend, Sierra Blend, Timber Blend and Weathered Blend colors include steel in top rail.
- B MID RAIL** PALLET QUANTITY = 138
2" x 4" x 95-1/2"
- C PICKETS** PALLET QUANTITY = 480
26 pickets of 7/8" x 3" x 71-5/8"
- D BOTTOM RAIL** PALLET QUANTITY = 138
2" x 4" x 95-1/2"
Includes steel reinforcement channel.
- E POST** PALLET QUANTITY = 48
5" x 5" x 107"

Racks up to 5 degrees



**FEATURING
WINDZONE™
TECHNOLOGY**



**MEETS
POOL
CODE**

Note: 2" x 4" = 1-3/4" x 3-1/2"

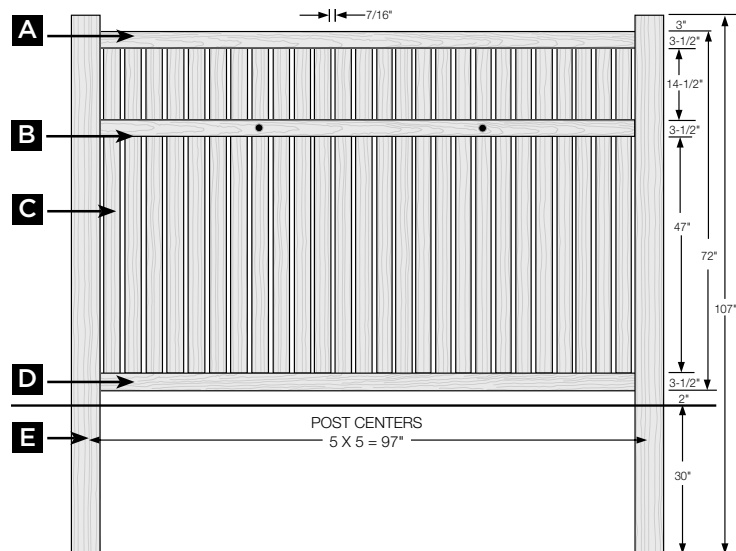

QUANTITY	PRODUCT NUMBER	DESCRIPTION
FENCE SECTIONS		
_____	204258	Millbrook Fence Section (5 ft. x 8 ft.)
<i>Note: Fence section includes A, B, C, D and section hardware. Post and caps sold separately.</i>		
5 IN. X 5 IN. POSTS		
_____	525113	Millbrook Corner Post 5 in. x 5 in. x 96 in.
_____	525123	Millbrook Line Post 5 in. x 5 in. x 96 in.
_____	525133	Millbrook End Post 5 in. x 5 in. x 96 in.
_____	539096	Blank Post 5 in. x 5 in. x 96 in.
POST CAPS		
_____	70493	Ball Cap 5 in. x 5 in.
_____	70416	Gothic Cap Ext 5 in. x 5 in.
_____	70418	Flat Cap Ext 5 in. x 5 in.
_____	70427	New England Cap Ext 5 in. x 5 in.
GATES (hardware ordered separately)		
_____	42719	Millbrook Gate Kit (builds up to 50 in. wide gate)
_____	70031	Gate Extension Kit (builds up to 60 in. gate) gate kit must also be ordered
_____	437050	Millbrook Preassembled Gate 50 in. Wide
_____	70095	Aluminum 5 in. x 5 in. x 94 in. Gate Post Stiffener
_____	27635	Drop Pin Kit
_____	27742	5 ft. to 6 ft. Height Gate Hardware (self-closing hinges and latch)
_____	27745	Deluxe Key Entry Nylon Gate Hardware (5 ft. and 6 ft. height fence)
_____	27752	Plus Key Entry Nylon Gate Hardware (5 ft. and 6 ft. height fence)
_____	27747	LokkLatch Magnetic Gate Hardware (5 ft. and 6 ft. height fence)
_____	27731	Standard Stainless Steel Gate Hardware Pebble Black Finish
<i>Note: Gate kits include (2) 2-1/2 in. x 4 in. up-rights caps, and screws. Rails and pickets ordered separately.</i>		
OPTIONAL/EXTRA MATERIAL		
_____	70090	Steel Reinforcement Channel x 92 in. for 2 in. x 6 in. Rail
_____	589218	Millbrook 2 in. x 6 in. x 94-1/2 in. Routed Top Rail
_____	589238	Millbrook 2 in. x 6 in. x 94-1/2 in. Routed Bottom Rail with Steel
_____	589318	Millbrook 2 in. x 4 in. x 94-1/2 in. Routed Mid Rail
_____	60783P	Lock Rings (order 2 per rail) Qty: 24
_____	359051	Picket 7/8 in. x 6 in. x 51-5/8 in. Ribbed
_____	71414	2 in. EZ Set Post Brackets (pair with hardware - optional)

Note: Attach Mid Rail with supplied hardware.

Note: 2" x 4" = 1-3/4" x 3-1/2"

- A TOP RAIL** PALLET QUANTITY = 84
2" x 6" x 94-1/2"
- B MID RAIL** PALLET QUANTITY = 138
2" x 4" x 94-1/2"
- C PICKETS** PALLET QUANTITY = 196
13 pieces of 7/8" x 6" x 51-5/8"
- D BOTTOM RAIL**
PALLET QUANTITY = 84
2" x 6" x 94-1/2"
Includes steel reinforcement channel.
- E POST** PALLET QUANTITY = 48
5" x 5" x 96"

Racks up to 5 degrees

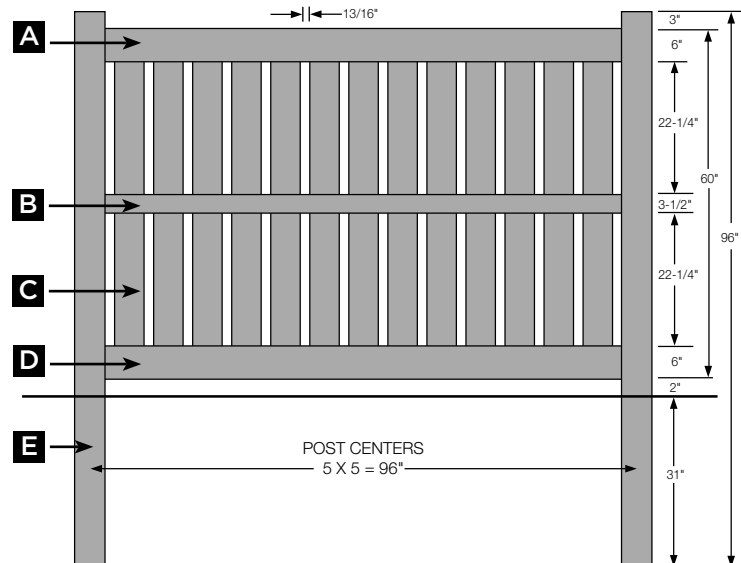

QUANTITY	PRODUCT NUMBER	DESCRIPTION
FENCE SECTIONS		
_____	204268	Millbrook Fence Section (6 ft. x 8 ft.)
<i>Note: Fence section includes A, B, C, D and section hardware. Post and caps sold separately.</i>		
5 IN. X 5 IN. POSTS		
_____	676413	Millbrook Corner Post 5 in. x 5 in. x 107 in.
_____	676423	Millbrook Line Post 5 in. x 5 in. x 107 in.
_____	676433	Millbrook End Post 5 in. x 5 in. x 107 in.
_____	679108	Blank Post Heavy Wall 5 in. x 5 in. x 107 in.
POST CAPS		
_____	70493	Ball Cap 5 in. x 5 in.
_____	70416	Gothic Cap Ext 5 in. x 5 in.
_____	70418	Flat Cap Ext 5 in. x 5 in.
_____	70427	New England Cap Ext 5 in. x 5 in.
GATES (hardware ordered separately)		
_____	42720	Millbrook Gate Kit (builds up to 50 in. wide gate)
_____	70031	Gate Extension Kit (builds up to 60 in. gate) gate kit must also be ordered
_____	437051	Millbrook Preassembled Gate 50 in. Wide
_____	70106	Aluminum 5 in. x 5 in. x 106 in. Gate Post Stiffener
_____	27635	Drop Pin Kit
_____	27742	5 ft. to 6 ft. Height Gate Hardware (self-closing hinges and latch)
_____	27745	Deluxe Key Entry Nylon Gate Hardware (5 ft. and 6 ft. height fence)
_____	27752	Plus Key Entry Nylon Gate Hardware (5 ft. and 6 ft. height fence)
_____	27747	LokkLatch Magnetic Gate Hardware (5 ft. and 6 ft. height fence)
_____	27731	Standard Stainless Steel Gate Hardware Pebble Black Finish
<i>Note: Gate kits include (2) 2-1/2 in. x 4 in. up-rights, caps and screws. Rails and pickets ordered separately.</i>		
OPTIONAL/EXTRA MATERIAL		
_____	70090	Steel Reinforcement Channel x 92 in. for 2 in. x 6 in. Rail
_____	589218	Millbrook 2 in. x 6 in. x 94-1/2 in. Routed Top Rail
_____	589238	Millbrook 2 in. x 6 in. x 94-1/2 in. Routed Bottom Rail with Steel
_____	589318	Millbrook 2 in. x 4 in. x 94-1/2 in. Routed Mid Rail
_____	60783P	Lock Rings (order 2 per rail) Qty: 24
_____	359063	Picket 7/8 in. x 6 in. x 63-5/8 in. Ribbed
_____	71414	2 in. EZ Set Post Brackets (pair with hardware - optional)

Note: Attach Mid Rail with supplied hardware.

Note: 2" x 4" = 1-3/4" x 3-1/2"

- A TOP RAIL** PALLET QUANTITY = 84
2" x 6" x 94-1/2"
- B MID RAIL** PALLET QUANTITY = 138
2" x 4" x 94-1/2"
- C PICKETS** PALLET QUANTITY = 196
13 pieces of 7/8" x 6" x 63-5/8"
- D BOTTOM RAIL**
PALLET QUANTITY = 84
2" x 6" x 94-1/2"
Includes steel reinforcement channel.
- E POST** PALLET QUANTITY = 48
5" x 5" x 107"

Racks up to 5 degrees

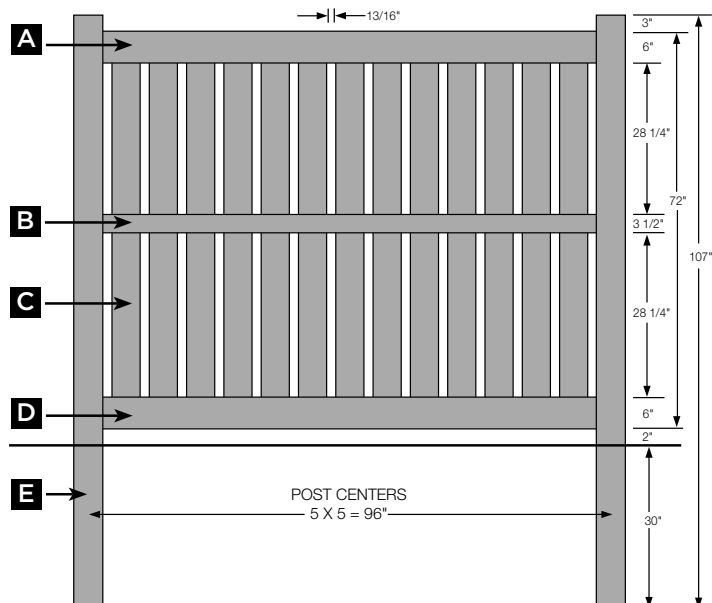

**Contemporary
Baron**

4 ft. High / 8 ft. Wide

Select one of the available colors
 ■ Almond ■ Clay ■ White

For colors, add color letters to item number: Almond (AL), Clay (C).

Note: Mixed color sections must be ordered as components; pricing will be higher than standard sections.

QUANTITY	PRODUCT NUMBER	DESCRIPTION
FENCE SECTIONS		
_____	201544	Baron Fence Section (4 ft. x 8 ft.)

Note: Fence section includes A, B, C and section hardware. Post and caps sold separately.

4 IN. X 4 IN. POSTS		
_____	64471	Corner Post 4 in. x 4 in. x 84 in.
_____	64472	Line Post 4 in. x 4 in. x 84 in.
_____	64473	End Post 4 in. x 4 in. x 84 in.
_____	649084	Blank Post 4 in. x 4 in. x 84 in.

POST CAPS		
_____	70409	Gothic Cap Ext 4 in. x 4 in.
_____	70411	Flat Cap Int 4 in. x 4 in.
_____	70492	Ball Cap 4 in. x 4 in.
_____	70414	Flat Cap Ext 4 in. x 4 in.
_____	70426	New England Cap 4 in. x 4 in.

GATES (hardware ordered separately)		
_____	42716	Gate Kit (builds up to 50 in. wide gate)
_____	70029	Gate Extension Kit (builds to 72 in. wide gate) gate kit must also be ordered
_____	437032	Baron Preassembled Gate 50 in. Wide
_____	70082	Aluminum 4 in. x 4 in. x 82 in. Gate Post Stiffener
_____	27630	MagnaLatch
_____	27635	Drop Pin Kit
_____	27741	3 ft. to 4 ft. Height Gate Hardware (self-closing hinges and latch)
_____	27744	Deluxe Key Entry Nylon Gate Hardware (3 ft. and 4 ft. height fence)
_____	27751	Plus Key Entry Nylon Gate Hardware (3 ft. and 4 ft. height fence)
_____	27731	Standard Stainless Steel Gate Hardware Pebble Black Finish

Note: Gate kits include (2) 2-1/2 in. x 4 in up-rights, caps and screws. Rails and pickets ordered separately.

OPTIONAL/EXTRA MATERIAL		
_____	70292	Aluminum Reinforcement Channel x 92 in. or 2 in. x 4 in. (optional)
_____	70092	Steel Reinforcement Channel x 92 in. for 2 in. x 4 in. (required for top rail of WindZone system)
_____	28456	Baron 2 in. x 4 in. x 95-1/2 in. Routed Top Rail
_____	28454	T15 2 in. x 4 in. x 95-1/2 in. Routed Bottom Rail with Steel
_____	349048	Picket 7/8 in. x 3 in. x 48 in.
_____	71413	1-5/8 in. EZ Set Post Brackets (pair with hardware - optional)

Note: 2" x 4" = 1-3/4" x 3-1/2"

- A TOP RAIL**
 PALLET QUANTITY = 138
 2" x 4" x 95-1/2"
 Note: Clay color includes steel in top rail.
- B PICKETS**
 PALLET QUANTITY = 480
 15 pieces of 7/8" x 3" x 48"
- C BOTTOM RAIL**
 PALLET QUANTITY = 138
 2" x 4" x 95-1/2" Includes steel channel.
- D POST**
 PALLET QUANTITY = 60
 4" x 4" x 84"

Racks up to 10 degrees



**MEETS
POOL
CODE**

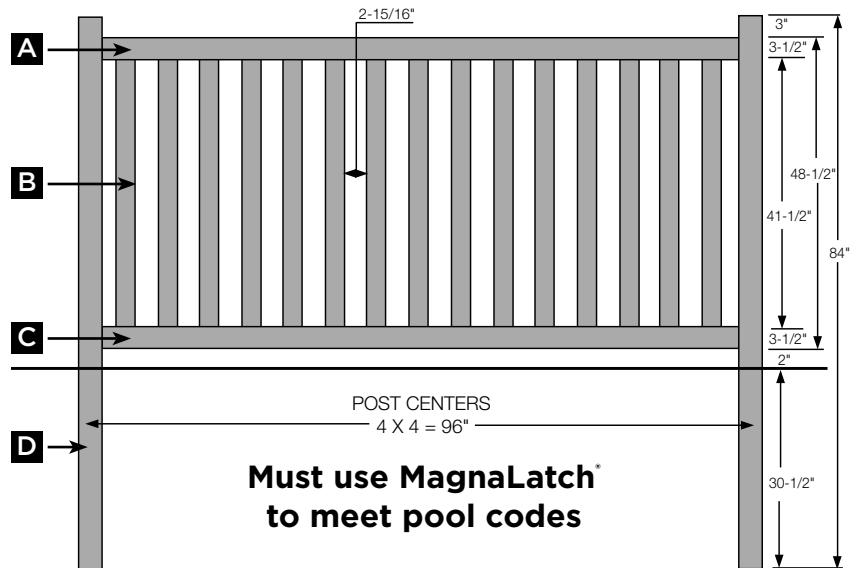

**Contemporary
Baron**

5 ft. High / 8 ft. Wide

Select one of the available colors
 ■ Almond ■ Clay ■ White

For colors, add color letters to item number: Almond (AL), Clay (C).

Note: Mixed color sections must be ordered as components; pricing will be higher than standard sections.

QUANTITY	PRODUCT NUMBER	DESCRIPTION
FENCE SECTIONS		
_____	201554	Baron Fence Section (5 ft. x 8 ft.)

Note: Fence section includes A, B, C, D and section hardware. Post and caps sold separately.

5 IN. X 5 IN. POSTS		
_____	52111	Corner Post 5 in. x 5 in. x 96 in.
_____	52112	Line Post 5 in. x 5 in. x 96 in.
_____	52113	End Post 5 in. x 5 in. x 96 in.
_____	539096	Blank Post 5 in. x 5 in. x 96 in.

POST CAPS		
_____	70416	Gothic Cap Ext 5 in. x 5 in.
_____	70417	Flat Cap Int 5 in. x 5 in.
_____	70493	Ball Cap 5 in. x 5 in.
_____	70418	Flat Cap Ext 5 in. x 5 in.
_____	70427	New England Cap Ext 5 in. x 5 in.

GATES (hardware ordered separately)		
_____	42717	Gate Kit (builds up to 50 in. wide gate)
_____	70029	Gate Extension Kit (builds to 72 in. wide gate) gate kit must also be ordered
_____	437038	Baron Preamsembled Gate 50 in. Wide
_____	70095	Aluminum 5 in. x 5 in. x 94 in. Gate Post Stiffener
_____	27635	Drop Pin Kit
_____	27742	5 ft. to 6 ft. Height Gate Hardware (self-closing hinges and latch)
_____	27745	Deluxe Key Entry Nylon Gate Hardware (5 ft. and 6 ft. height fence)
_____	27752	Plus Key Entry Nylon Gate Hardware (5 ft. and 6 ft. height fence)
_____	27747	LokkLatch Magnetic Gate Hardware (5 ft. and 6 ft. height fence)
_____	27731	Standard Stainless Steel Gate Hardware Pebble Black Finish

Note: Gate kits include (2) 2-1/2 in. x 4 in. up-rights, caps and screws. Rails and pickets ordered separately.

OPTIONAL/EXTRA MATERIAL		
_____	70292	Aluminum Reinforcement Channel x 92 in. or 2 in. x 4 in. (optional)
_____	70092	Steel Reinforcement Channel x 92 in. for 2 in. x 4 in. (required for top rail of WindZone system)
_____	28456	Baron 2 in. x 4 in. x 95-1/2 in. Routed Top Rail
_____	28454	T15 2 in. x 4 in. x 95-1/2 in. Routed Bottom Rail with Steel
_____	28453	T15 2 in. x 4 in. x 95-1/2 in. Routed Mid Rail
_____	349060	Picket 7/8 in. x 3 in. x 59-5/8 in.
_____	71414	2 in. EZ Set Post Brackets (pair with hardware - optional)

Note: Attach Mid Rail with supplied hardware.

Note: 2" x 4" = 1-3/4" x 3-1/2"

- A TOP RAIL** PALLET QUANTITY = 138
2" x 4" x 95-1/2"
Note: Clay color includes steel in top rail.
- B MID RAIL** PALLET QUANTITY = 138
2" x 4" x 95-1/2"
- C PICKETS** PALLET QUANTITY = 480
15 pieces of 7/8" x 3" x 59-5/8"
- D BOTTOM RAIL** PALLET QUANTITY = 138
2" x 4" x 95-1/2"
Includes steel channel.
- E POST** PALLET QUANTITY = 48
5" x 5" x 96"

Racks up to 5 degrees



**MEETS
POOL
CODE**

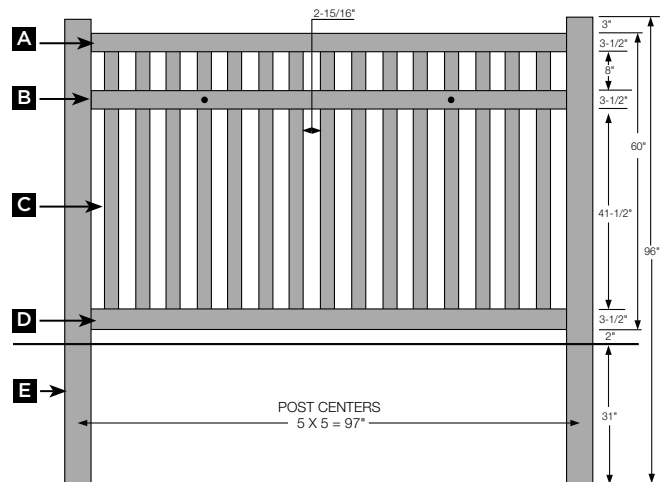

Contemporary Baron

6 ft. High / 8 ft. Wide

Select one of the available colors
 ■ Almond ■ Clay ■ White

For colors, add color letters to item number: Almond (AL), Clay (C).

Note: Mixed color sections must be ordered as components; pricing will be higher than standard sections.

QUANTITY	PRODUCT NUMBER	DESCRIPTION
FENCE SECTIONS		
_____	201564	Baron Fence Section (6 ft. x 8 ft.)
<i>Note: Fence section includes A, B, C, D and section hardware. Post and caps sold separately.</i>		
5 IN. X 5 IN. POSTS		
_____	67491	Corner Post 5 in. x 5 in. x 107 in.
_____	67492	Line Post 5 in. x 5 in. x 107 in.
_____	67493	End Post 5 in. x 5 in. x 107 in.
_____	679108	Blank Post Heavy Wall 5 in. x 5 in. x 107 in.
POST CAPS		
_____	70416	Gothic Cap Ext 5 in. x 5 in.
_____	70493	Ball Cap 5 in. x 5 in.
_____	70418	Flat Cap Ext 5 in. x 5 in.
_____	70427	New England Cap Ext 5 in. x 5 in.
GATES (hardware ordered separately)		
_____	42718	Gate Kit (builds up to 50 in. wide gate)
_____	70029	Gate Extension Kit (builds to 72 in. wide gate) gate kit must also be ordered
_____	437044	Baron Preassembled Gate 50 in. Wide
_____	70106	Aluminum 5 in. x 5 in. x 106 in. Gate Post Stiffener
_____	27635	Drop Pin Kit
_____	27742	5 ft. to 6 ft. Height Gate Hardware (self-closing hinges and latch)
_____	27745	Deluxe Key Entry Nylon Gate Hardware (5 ft. and 6 ft. height fence)
_____	27752	Plus Key Entry Nylon Gate Hardware (5 ft. and 6 ft. height fence)
_____	27747	LokkLatch Magnetic Gate Hardware (5 ft. and 6 ft. height fence)
_____	27731	Standard Stainless Steel Gate Hardware Pebble Black Finish
<i>Note: Gate kits include (2) 2-1/2 in. x 4 in. up-rights, caps and screws. Rails and pickets ordered separately.</i>		
OPTIONAL/EXTRA MATERIAL		
_____	70292	Aluminum Reinforcement Channel x 92 in. or 2 in. x 4 in. (optional)
_____	70092	Steel Reinforcement Channel x 92 in. for 2 in. x 4 in. (required for top rail of WindZone system)
_____	28456	Baron 2 in. x 4 in. x 95-1/2 in. Routed Top Rail
_____	28454	T15 2 in. x 4 in. x 95-1/2 in. Routed Bottom Rail with Steel
_____	28453	T15 2 in. x 4 in. x 95-1/2 in. Routed Mid Rail
_____	349072	Picket 7/8 in. x 3 in. x 71-5/8 in.
_____	71414	2 in. EZ Set Post Brackets (pair with hardware - optional)

Note: Attach Mid Rail with supplied hardware.

Note: 2" x 4" = 1-3/4" x 3-1/2"

- A TOP RAIL**
 PALLET QUANTITY = 138
 2" x 4" x 95-1/2"
 Note: Clay color includes steel in top rail.
- B MID RAIL**
 PALLET QUANTITY = 138
 2" x 4" x 95-1/2"
- C PICKETS**
 PALLET QUANTITY = 480
 15 pieces of 7/8" x 3" x 71-5/8"
- D BOTTOM RAIL**
 PALLET QUANTITY = 138
 2" x 4" x 95-1/2"
 Includes steel channel.
- E POST**
 PALLET QUANTITY = 48
 5" x 5" x 107"

Racks up to 5 degrees



MEETS POOL CODE

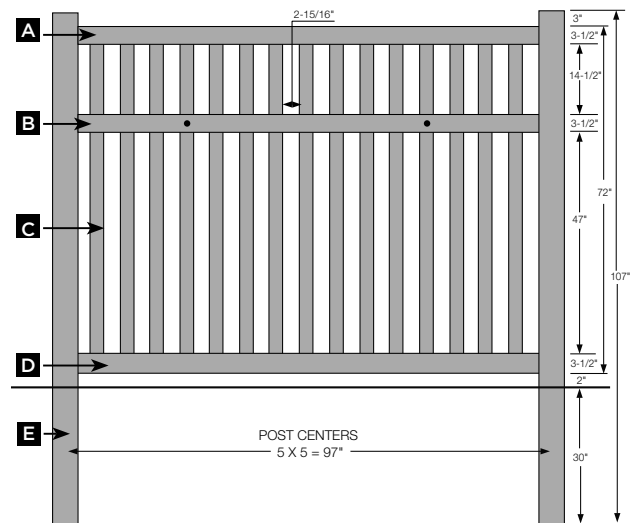

**Contemporary
Baron with Select Cedar Texture**

4 ft. High / 8 ft. Wide

- Select one of the available colors**
- Almond ■ Arbor Blend ■ Arctic Blend
 - Brazilian Blend ■ Clay
 - Frontier Blend ■ Sierra Blend
 - Timber Blend ■ Weathered Blend
 - White

For colors, add color letters to item number: Almond (AL), Arbor Blend (AR4), Arctic Blend (AC4), Brazilian Blend (BR4), Clay (C), Frontier Blend (FB4), Sierra Blend (SB4), Timber Blend (TB4), Weathered Blend (WB4).
Note: Mixed color sections must be ordered as components; pricing will be higher than standard sections.

QUANTITY	PRODUCT NUMBER	DESCRIPTION
FENCE SECTIONS		
_____	30404	Select Cedar Baron Fence Section (4 ft. x 8 ft.)
<i>Note: Fence section includes A, B, C and section hardware. Post and caps sold separately.</i>		
5 IN. X 5 IN. POSTS		
_____	75721	Textured Corner Post 5 in. x 5 in. x 84 in.
_____	75722	Textured Line Post 5 in. x 5 in. x 84 in.
_____	75723	Textured End Post 5 in. x 5 in. x 84 in.
_____	759084	CertaGrain Blank Post 5 in. x 5 in. x 84 in.
POST CAPS		
_____	70444	CertaGrain Flat Top Cap Ext 5 in. x 5 in.
_____	70459	Textured New England Cap 5 in. x 5 in.
GATES (hardware ordered separately)		
_____	42739	Textured Gate Kit (builds up to 50 in. wide gate)
_____	70029	Gate Extension Kit (builds to 72 in. wide gate) gate kit must also be ordered
_____	437074	Baron Select Cedar Preassembled Gate 50 in. Wide
_____	70095	Aluminum 5 in. x 5 in. x 94 in. Gate Post Stiffener
_____	27630	MagnaLatch
_____	27635	Drop Pin Kit
_____	27742	5 ft. to 6 ft. Height Gate Hardware (self-closing hinges and latch)
_____	27745	Deluxe Key Entry Nylon Gate Hardware (5 ft. and 6 ft. height fence)
_____	27752	Plus Key Entry Nylon Gate Hardware (5 ft. and 6 ft. height fence)
_____	27747	LokkLatch Magnetic Gate Hardware (5 ft. and 6 ft. height fence)
_____	27731	Standard Stainless Steel Gate Hardware Pebble Black Finish
<i>Note: Gate kits include (2) 2-1/2 in. x 4 in. up-rights, caps and screws. Rails and pickets ordered separately.</i>		
OPTIONAL/EXTRA MATERIAL		
_____	70292	Aluminum Reinforcement Channel x 92 in. or 2 in. x 4 in. (optional)
_____	70092	Steel Reinforcement Channel x 92 in. for 2 in. x 4 in. (required for top rail of WindZone system)
_____	906001	Baron Select Cedar 2 in. x 4 in. x 95-1/2 in. RoutedTop Rail
_____	906002	T15 Select Cedar 2 in. x 4 in. x 95-1/2 in. Routed Bottom Rail with Steel
_____	929048	Select Cedar Picket 7/8 in. x 3 in. x 48 in.
_____	71414	2 in. EZ Set Post Brackets (pair with hardware - optional)

Note: 2" x 4" = 1-3/4" x 3-1/2"

- A TOP RAIL**
PALLET QUANTITY = 138
2" x 4" x 95-1/2"
Note: Arbor Blend, Arctic Blend, Brazilian Blend, Clay, Frontier Blend, Sierra Blend, Timber Blend and Weathered Blend colors include steel in top rail.
- B PICKETS**
PALLET QUANTITY = 480
15 pieces of 7/8" x 3" x 48"
- C BOTTOM RAIL**
PALLET QUANTITY = 138
2" x 4" x 95-1/2" Includes steel channel.
- D POST**
PALLET QUANTITY = 48
5" x 5" x 84"

Racks up to 10 degrees



**MEETS
POOL
CODE**

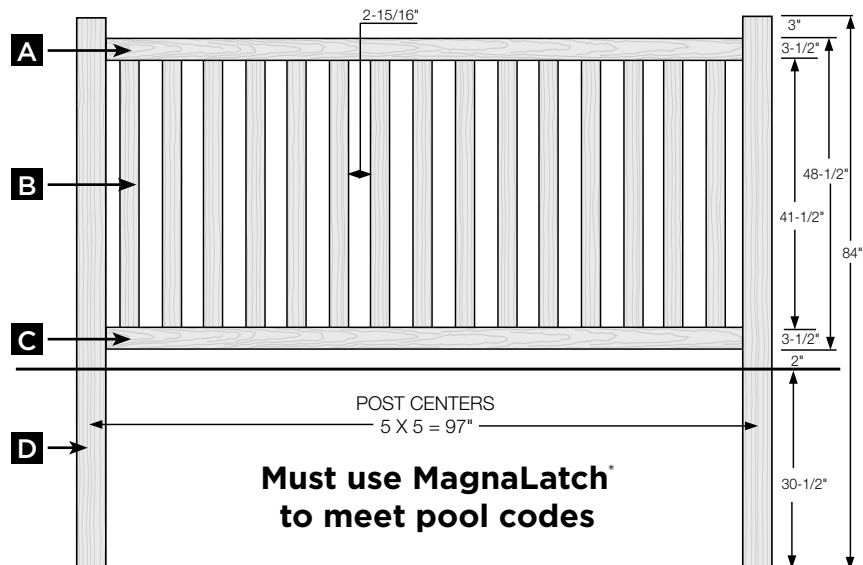

**Contemporary
Baron with Select Cedar Texture**

5 ft. High / 8 ft. Wide

- Select one of the available colors**
- Almond ■ Arbor Blend ■ Arctic Blend
 - Brazilian Blend ■ Clay
 - Frontier Blend ■ Sierra Blend
 - Timber Blend ■ Weathered Blend
 - White

*For colors, add color letters to item number: Almond (AL), Arbor Blend (AR4), Arctic Blend (AC4), Brazilian Blend (BR4), Clay (C), Frontier Blend (FB4), Sierra Blend (SB4), Timber Blend (TB4), Weathered Blend (WB4).
Note: Mixed color sections must be ordered as components; pricing will be higher than standard sections.*

QUANTITY	PRODUCT NUMBER	DESCRIPTION
FENCE SECTIONS		
_____	30405	Select Cedar Baron Fence Section (5 ft. x 8 ft.)
<i>Note: Fence section includes A, B, C, D and section hardware. Post and caps sold separately.</i>		
5 IN. X 5 IN. POSTS		
_____	75701	Textured Corner Post 5 in. x 5 in. x 96 in.
_____	75702	Textured Line Post 5 in. x 5 in. x 96 in.
_____	75703	Textured End Post 5 in. x 5 in. x 96 in.
_____	759096	CertaGrain Blank Post Heavy Wall 5 in. x 5 in. x 96 in.
POST CAPS		
_____	70444	CertaGrain Flat Top Cap Ext 5 in. x 5 in.
_____	70459	Textured New England Cap 5 in. x 5 in.
GATES (hardware ordered separately)		
_____	42740	Textured Gate Kit (builds up to 50 in. wide gate)
_____	70029	Gate Extension Kit (builds to 72 in. wide gate) gate kit must also be ordered
_____	437075	Baron Select Cedar Preassembled Gate 50 in. Wide
_____	70095	Aluminum 5 in. x 5 in. x 94 in. Gate Post Stiffener
_____	27635	Drop Pin Kit
_____	27742	5 ft. to 6 ft. Height Gate Hardware (self-closing hinges and latch)
_____	27745	Deluxe Key Entry Nylon Gate Hardware (5 ft. and 6 ft. height fence)
_____	27752	Plus Key Entry Nylon Gate Hardware (5 ft. and 6 ft. height fence)
_____	27747	LokkLatch Magnetic Gate Hardware (5 ft. and 6 ft. height fence)
_____	27731	Standard Stainless Steel Gate Hardware Pebble Black Finish
<i>Note: Gate kits include (2) 2-1/2 in. x 4 in. up-rights, caps and screws. Rails and pickets ordered separately.</i>		
OPTIONAL/EXTRA MATERIAL		
_____	70292	Aluminum Reinforcement Channel x 92 in. or 2 in. x 4 in. (optional)
_____	70092	Steel Reinforcement Channel x 92 in. for 2 in. x 4 in. (required for top rail of WindZone system)
_____	906001	Baron Select Cedar 2 in. x 4 in. x 95-1/2 in. Routed Top Rail
_____	906002	T15 Select Cedar 2 in. x 4 in. x 95-1/2 in. Routed Bottom Rail with Steel
_____	906003	T15 Select Cedar 2 in. x 4 in. x 95-1/2 in. Routed Mid Rail
_____	929060	Select Cedar Picket 7/8 in. x 3 in. x 59-5/8 in.
_____	71414	2 in. EZ Set Post Brackets (pair with hardware - optional)

Note: Attach Mid Rail with supplied hardware.

A TOP RAIL

PALLET QUANTITY = 138
2" x 4" x 95-1/2"

Note: Arbor Blend, Arctic Blend, Brazilian Blend, Clay, Frontier Blend, Sierra Blend, Timber Blend and Weathered Blend colors include steel in top rail.

B MID RAIL

PALLET QUANTITY = 138
2" x 4" x 95-1/2"

C PICKETS

PALLET QUANTITY = 480
15 pieces of 7/8" x 3" x 59-5/8"

D BOTTOM RAIL

PALLET QUANTITY = 138
2" x 4" x 95-1/2"
Includes steel channel.

E POST PALLET QUANTITY = 48

5" x 5" x 96"

Racks up to 5 degrees



**MEETS
POOL
CODE**

Note: 2" x 4" = 1-3/4" x 3-1/2"

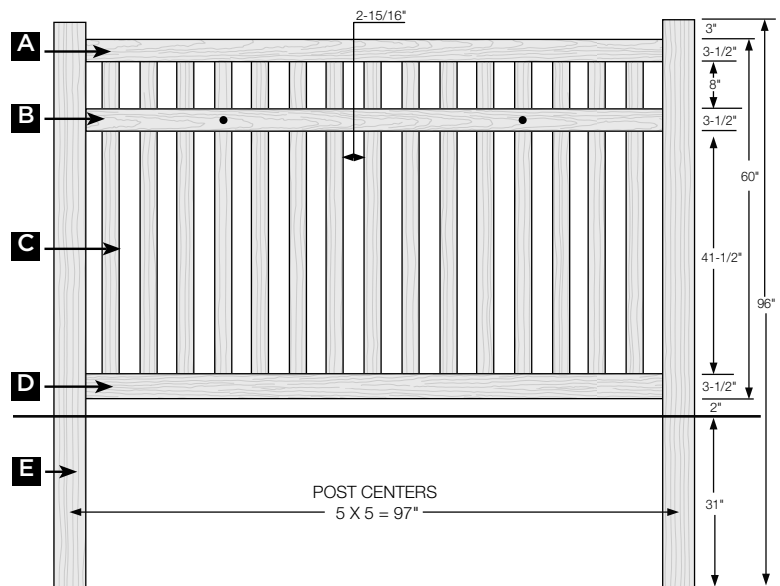

**Contemporary
Baron with Select Cedar Texture**

6 ft. High / 8 ft. Wide

- Select one of the available colors**
- Almond ■ Arbor Blend ■ Arctic Blend
 - Brazilian Blend ■ Clay
 - Frontier Blend ■ Sierra Blend
 - Timber Blend ■ Weathered Blend
 - White

For colors, add color letters to item number: Almond (AL), Arbor Blend (AR4), Arctic Blend (AC4), Brazilian Blend (BR4), Clay (C), Frontier Blend (FB4), Sierra Blend (SB4), Timber Blend (TB4), Weathered Blend (WB4).
Note: Mixed color sections must be ordered as components; pricing will be higher than standard sections.

QUANTITY	PRODUCT NUMBER	DESCRIPTION
FENCE SECTIONS		
_____	30406	Select Cedar Baron Fence Section (6 ft. x 8 ft.)
<i>Note: Fence Section includes A, B, C, D and section hardware. Post and caps sold separately.</i>		
5 IN. X 5 IN. POSTS		
_____	75711	Textured Corner Post 5 in. x 5 in. x 107 in.
_____	75712	Textured Line Post 5 in. x 5 in. x 107 in.
_____	75713	Textured End Post 5 in. x 5 in. x 107 in.
_____	759108	CertaGrain Blank Post Heavy Wall 5 in. x 5 in. x 107 in.
POST CAPS		
_____	70444	CertaGrain Flat Top Cap Ext 5 in. x 5 in.
_____	70459	Textured New England Cap 5 in. x 5 in.
GATES (hardware ordered separately)		
_____	42741	Textured Gate Kit (builds up to 50 in. wide gate)
_____	70029	Gate Extension Kit (builds to 72 in. wide gate) gate kit must also be ordered
_____	437076	Baron Select Cedar Preassembled Gate 50 in. Wide
_____	70106	Aluminum 5 in. x 5 in. x 106 in. Gate Post Stiffener
_____	27635	Drop Pin Kit
_____	27742	5 ft. to 6 ft. Height Gate Hardware (self-closing hinges and latch)
_____	27745	Deluxe Key Entry Nylon Gate Hardware (5 ft. and 6 ft. height fence)
_____	27752	Plus Key Entry Nylon Gate Hardware (5 ft. and 6 ft. height fence)
_____	27747	LokkLatch Magnetic Gate Hardware (5 ft. and 6 ft. height fence)
_____	27731	Standard Stainless Steel Gate Hardware Pebble Black Finish
<i>Note: Gate kits include (2) 2-1/2 in. x 4 in. up-rights, caps and screws. Rails and pickets ordered separately.</i>		
OPTIONAL/EXTRA MATERIAL		
_____	70292	Aluminum Reinforcement Channel x 92 in. or 2 in. x 4 in. (optional)
_____	70092	Steel Reinforcement Channel x 92 in. for 2 in. x 4 in. (required for top rail of WindZone system)
_____	906001	Baron Select Cedar 2 in. x 4 in. x 95-1/2 in. Routed Top Rail
_____	906002	T15 Select Cedar 2 in. x 4 in. x 95-1/2 in. Routed Bottom Rail with Steel
_____	906003	T15 Select Cedar 2 in. x 4 in. x 95-1/2 in. Routed Mid Rail
_____	929072	Select Cedar Picket 7/8 in. x 3 in. x 71-5/8 in.
_____	71414	2 in. EZ Set Post Brackets (pair with hardware - optional)

Note: Attach Mid Rail with supplied hardware.

A TOP RAIL

PALLET QUANTITY = 138
2" x 4" x 95-1/2"

Note: Arbor Blend, Arctic Blend, Brazilian Blend, Clay, Frontier Blend, Sierra Blend, Timber Blend and Weathered Blend colors include steel in top rail.

B MID RAIL

PALLET QUANTITY = 138
2" x 4" x 95-1/2"

C PICKETS

PALLET QUANTITY = 480
15 pieces of 7/8" x 3" x 71-5/8"

D BOTTOM RAIL

PALLET QUANTITY = 138
2" x 4" x 95-1/2"
Includes steel channel.

E POST PALLET QUANTITY = 48

5" x 5" x 107"

Racks up to 5 degrees



**MEETS
POOL
CODE**

Note: 2" x 4" = 1-3/4" x 3-1/2"

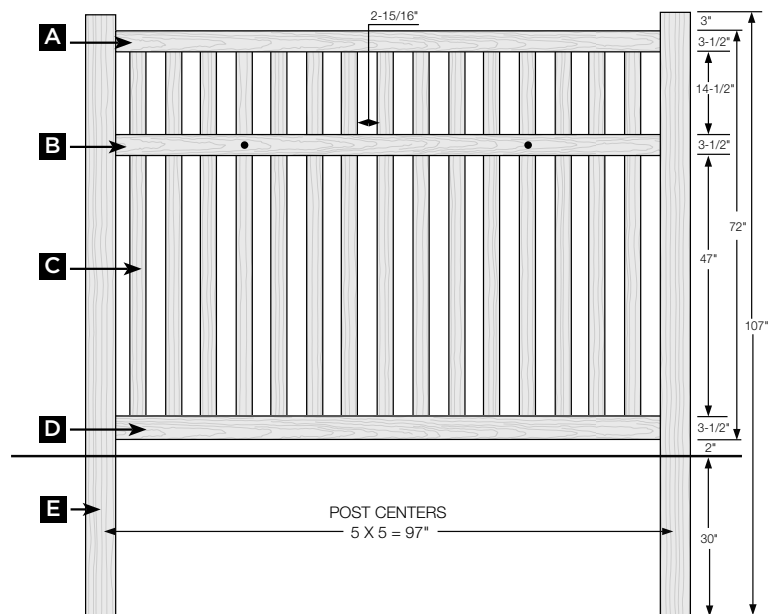

Contemporary Countess

4 ft. High / 8 ft. Wide

Select one of the available colors
 ■ Almond ■ White

For Almond, add (AL) to item number.

Note: Mixed color sections must be ordered as components; pricing will be higher than standard sections.

QUANTITY	PRODUCT NUMBER	DESCRIPTION
FENCE SECTIONS		
_____	202748	Countess Fence Section (4 ft. x 8 ft.)
<i>Note: Fence section includes A, B, C and section hardware. Post and caps sold separately.</i>		
4 IN. X 4 IN. POSTS		
_____	64471	Corner Post 4 in. x 4 in. x 84 in.
_____	64472	Line Post 4 in. x 4 in. x 84 in.
_____	64473	End Post 4 in. x 4 in. x 84 in.
_____	649084	Blank Post 4 in. x 4 in. x 84 in.
POST CAPS		
_____	70409	Gothic Cap Ext 4 in. x 4 in.
_____	70411	Flat Cap Int 4 in. x 4 in.
_____	70492	Ball Cap 4 in. x 4 in.
_____	70414	Flat Cap Ext 4 in. x 4 in.
_____	70426	New England Cap 4 in. x 4 in.
GATES (hardware ordered separately)		
_____	42716	Gate Kit (builds up to 50 in. wide gate)
_____	70029	Gate Extension Kit (builds to 72 in. wide gate) gate kit must also be ordered
_____	437033	Countess Psembled Gate 50 in. Wide
_____	70082	Aluminum 4 in. x 4 in. x 82 in. Gate Post Stiffener
_____	27630	MagnaLatch
_____	27635	Drop Pin Kit
_____	27741	3 ft. to 4 ft. Height Gate Hardware (self-closing hinges and latch)
_____	27744	Deluxe Key Entry Nylon Gate Hardware (3 ft. and 4 ft. height fence)
_____	27751	Plus Key Entry Nylon Gate Hardware (3 ft. and 4 ft. height fence)
_____	27731	Standard Stainless Steel Gate Hardware Pebble Black Finish
<i>Note: Gate kits include (2) 2-1/2 in. x 4 in. up-rights, caps and screws. Rails and pickets ordered separately.</i>		
OPTIONAL/EXTRA MATERIAL		
_____	70292	Aluminum Reinforcement Channel x 92 in. or 2 in. x 4 in. (optional)
_____	70092	Steel Reinforcement Channel x 92 in. for 2 in. x 4 in. (required for top rail of WindZone system)
_____	282618	Countess 2 in. x 4 in. x 95-1/2 in. Routed Top Rail
_____	282638	Countess 2 in. x 4 in. x 95-1/2 in. Routed Bottom Rail with Steel
_____	349048	Picket 7/8 in. x 3 in. x 48 in.
_____	319048	Picket 7/8 in. x 1-1/2 in. x 48 in.
_____	71413	1-5/8 in. EZ Set Post Brackets (pair with hardware - optional)

Note: 2" x 4" = 1-3/4" x 3-1/2"

- A TOP RAIL** PALLET QUANTITY = 138
2" x 4" x 95-1/2"
- B PICKETS**
14 pieces of 7/8" x 3" x 48"
PALLET QUANTITY = 480
8 pieces of 7/8" x 1-1/2" x 48"
PALLET QUANTITY = 1000
- C BOTTOM RAIL**
PALLET QUANTITY = 138
2" x 4" x 95-1/2" Includes steel channel.
- D POST** PALLET QUANTITY = 60
4" x 4" x 84"

Racks up to 10 degrees



**MEETS
POOL
CODE**

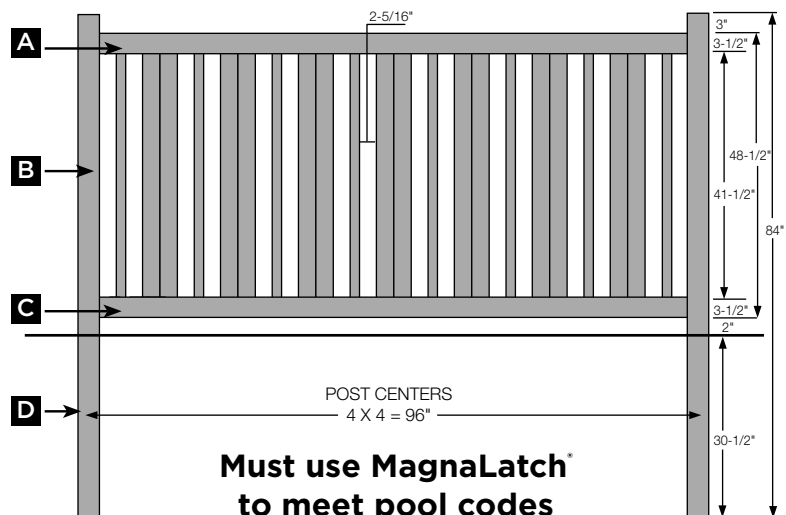

**Must use MagnaLatch[®]
to meet pool codes**

For Almond, add (AL) to item number.

Note: Mixed color sections must be ordered as components; pricing will be higher than standard sections.

QUANTITY	PRODUCT NUMBER	DESCRIPTION
FENCE SECTIONS		
_____	202758	Countess Fence Section (5 ft. x 8 ft.)

Note: Fence section includes A, B, C, D and section hardware. Post and caps sold separately.

5 IN. X 5 IN. POSTS		
_____	52111	Corner Post 5 in. x 5 in. x 96 in.
_____	52112	Line Post 5 in. x 5 in. x 96 in.
_____	52113	End Post 5 in. x 5 in. x 96 in.
_____	539096	Blank Post 5 in. x 5 in. x 96 in.

POST CAPS		
_____	70493	Ball Cap 5 in. x 5 in.
_____	70416	Gothic Cap Ext 5 in. x 5 in.
_____	70417	Flat Cap Int 5 in. x 5 in.
_____	70418	Flat Cap Ext 5 in. x 5 in.
_____	70427	New England Cap Ext 5 in. x 5 in.

GATES (hardware ordered separately)		
_____	42717	Gate Kit (builds up to 50 in. wide gate)
_____	70029	Gate Extension Kit (builds to 72 in. wide gate) gate kit must also be ordered
_____	437039	Countess Preassembled Gate 50 in. Wide
_____	70095	Aluminum 5 in. x 5 in. x 94 in. Gate Post Stiffener
_____	27635	Drop Pin Kit
_____	27742	5 ft. to 6 ft. Height Gate Hardware (self-closing hinges and latch)
_____	27745	Deluxe Key Entry Nylon Gate Hardware (5 ft. and 6 ft. height fence)
_____	27752	Plus Key Entry Nylon Gate Hardware (5 ft. and 6 ft. height fence)
_____	27747	LokkLatch Magnetic Gate Hardware (5 ft. and 6 ft. height fence)
_____	27731	Standard Stainless Steel Gate Hardware Pebble Black Finish

Note: Gate kits include (2) 2-1/2 in. x 4 in. up-rights, caps and screws. Rails and pickets ordered separately.

OPTIONAL/EXTRA MATERIAL		
_____	70292	Aluminum Reinforcement Channel x 92 in. or 2 in. x 4 in. (optional)
_____	70092	Steel Reinforcement Channel x 92 in. for 2 in. x 4 in. (required for top rail of WindZone system)
_____	282618	Countess 2 in. x 4 in. x 95-1/2 in. Routed Top Rail
_____	282718	Countess 2 in. x 4 in. x 95-1/2 in. Routed Mid Rail
_____	282638	Countess 2 in. x 4 in. x 95-1/2 in. Routed Bottom Rail with Steel
_____	349060	Picket 7/8 in. x 3 in. x 59-5/8 in.
_____	319060	Picket 7/8 in. x 1-1/2 in. x 59-5/8 in.
_____	71414	2 in. EZ Set Post Brackets (pair with hardware - optional)

Note: Attach Mid Rail with supplied hardware.

Note: 2" x 4" = 1-3/4" x 3-1/2"

- A TOP RAIL** PALLET QUANTITY = 138
2" x 4" x 95-1/2"
- B MID RAIL** PALLET QUANTITY = 138
2" x 4" x 95-1/2"
- C PICKETS**
14 pieces of 7/8" x 3" x 59-5/8"
PALLET QUANTITY = 480
8 pieces of 7/8" x 1-1/2" x 59-5/8"
PALLET QUANTITY = 1000
- D BOTTOM RAIL**
PALLET QUANTITY = 138
2" x 4" x 95-1/2"
Includes steel channel.
- E POST** PALLET QUANTITY = 48
5" x 5" x 96"

Racks up to 5 degrees



**MEETS
POOL
CODE**

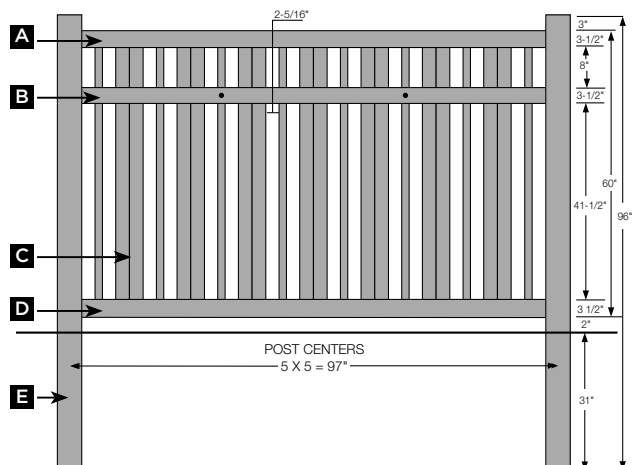

For Almond, add (AL) to item number.

Note: Mixed color sections must be ordered as components; pricing will be higher than standard sections.

QUANTITY	PRODUCT NUMBER	DESCRIPTION
FENCE SECTIONS		
_____	202768	Countess Fence Section (6 ft. x 8 ft.)
<i>Note: Fence section includes A, B, C, D and section hardware. Post and caps sold separately.</i>		
5 IN. X 5 IN. POSTS		
_____	67491	Corner Post 5 in. x 5 in. x 107 in.
_____	67492	Line Post 5 in. x 5 in. x 107 in.
_____	67493	End Post 5 in. x 5 in. x 107 in.
_____	679108	Blank Post Heavy Wall 5 in. x 5 in. x 107 in.
POST CAPS		
_____	70493	Ball Cap 5 in. x 5 in.
_____	70416	Gothic Cap Ext 5 in. x 5 in.
_____	70418	Flat Cap Ext 5 in. x 5 in.
_____	70427	New England Cap Ext 5 in. x 5 in.
GATES (hardware ordered separately)		
_____	42718	Gate Kit (builds up to 50 in. wide gate)
_____	70029	Gate Extension Kit (builds to 72 in. wide gate) gate kit must also be ordered
_____	437045	Countess Preassembled Gate 50 in. Wide
_____	70106	Aluminum 5 in. x 5 in. x 106 in. Gate Post Stiffener
_____	27635	Drop Pin Kit
_____	27742	5 ft. to 6 ft. Height Gate Hardware (self-closing hinges and latch)
_____	27745	Deluxe Key Entry Nylon Gate Hardware (5 ft. and 6 ft. height fence)
_____	27752	Plus Key Entry Nylon Gate Hardware (5 ft. and 6 ft. height fence)
_____	27747	LokkLatch Magnetic Gate Hardware (5 ft. and 6 ft. height fence)
_____	27731	Standard Stainless Steel Gate Hardware Pebble Black Finish
<i>Note: Gate kits include (2) 2-1/2 in. x 4 in. up-rights, caps and screws. Rails and pickets ordered separately.</i>		
OPTIONAL/EXTRA MATERIAL		
_____	70292	Aluminum Reinforcement Channel x 92 in. or 2 in. x 4 in. (optional)
_____	70092	Steel Reinforcement Channel x 92 in. for 2 in. x 4 in. (required for top rail of WindZone system)
_____	282618	Countess 2 in. x 4 in. x 95-1/2 in. Routed Top Rail
_____	282718	Countess 2 in. x 4 in. x 95-1/2 in. Routed Mid Rail
_____	282638	Countess 2 in. x 4 in. x 95-1/2 in. Routed Bottom Rail with Steel
_____	349072	Picket 7/8 in. x 3 in. x 71-5/8 in.
_____	319072	Picket 7/8 in. x 1-1/2 in. x 71-5/8 in.
_____	71414	2 in. EZ Set Post Brackets (pair with hardware - optional)

Note: Attach Mid Rail with supplied hardware.

Note: 2" x 4" = 1-3/4" x 3-1/2"

- A TOP RAIL** PALLET QUANTITY = 138
2" x 4" x 95-1/2"
- B MID RAIL** PALLET QUANTITY = 138
2" x 4" x 95-1/2"
- C PICKETS**
14 pieces of 7/8" x 3" x 71-5/8"
PALLET QUANTITY = 480
8 pieces of 7/8" x 1-1/2" x 71-5/8"
PALLET QUANTITY = 1000
- D BOTTOM RAIL**
PALLET QUANTITY = 138
2" x 4" x 95-1/2"
Includes steel channel.
- E POST** PALLET QUANTITY = 48
5" x 5" x 107"

Racks up to 5 degrees



**MEETS
POOL
CODE**

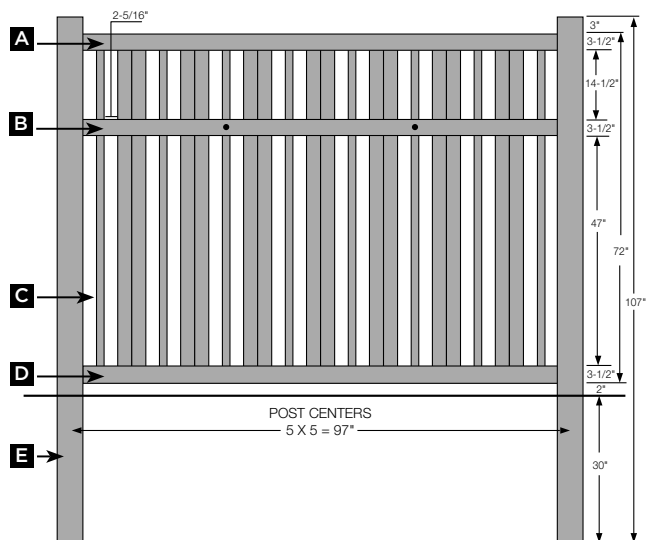

**Contemporary
Princeton**

4 ft. High / 8 ft. Wide

Select one of the available colors
 Almond White

For Almond, add (AL) to item number.

Note: Mixed color sections must be ordered as components; pricing will be higher than standard sections.

QUANTITY	PRODUCT NUMBER	DESCRIPTION
FENCE SECTIONS		
_____	205748	Princeton Fence Section (4 ft. x 8 ft.)

Note: Fence section includes A, B, C and section hardware. Post and caps sold separately.

4 IN. X 4 IN. POSTS		
_____	64471	Corner Post 4 in. x 4 in. x 84 in.
_____	64472	Line Post 4 in. x 4 in. x 84 in.
_____	64473	End Post 4 in. x 4 in. x 84 in.
_____	649084	Blank Post 4 in. x 4 in. x 84 in.

POST CAPS		
_____	70409	Gothic Cap Ext 4 in. x 4 in.
_____	70411	Flat Cap Int 4 in. x 4 in.
_____	70492	Ball Cap 4 in. x 4 in.
_____	70414	Flat Cap Ext 4 in. x 4 in.
_____	70426	New England Cap 4 in. x 4 in.

GATES (hardware ordered separately)		
_____	42716	Gate Kit (builds up to 50 in. wide gate)
_____	70029	Gate Extension Kit (builds to 72 in. wide gate) gate kit must also be ordered
_____	437035	Princeton Preassembled Gate 50 in. Wide
_____	70082	Aluminum 4 in. x 4 in. x 82 in. Gate Post Stiffener
_____	27630	MagnaLatch
_____	27635	Drop Pin Kit
_____	27741	3 ft. to 4 ft. Height Gate Hardware (self-closing hinges and latch)
_____	27744	Deluxe Key Entry Nylon Gate Hardware (3 ft. and 4 ft. height fence)
_____	27751	Plus Key Entry Nylon Gate Hardware (3 ft. and 4 ft. height fence)
_____	27731	Standard Stainless Steel Gate Hardware Pebble Black Finish

Note: Gate kits include (2) 2-1/2 in. x 4 in. up-rights, caps and screws. Rails and pickets ordered separately.

OPTIONAL/EXTRA MATERIAL		
_____	70292	Aluminum Reinforcement Channel x 92 in. or 2 in. x 4 in. (optional)
_____	70092	Steel Reinforcement Channel x 92 in. for 2 in. x 4 in. (required for top rail of WindZone system)
_____	285618	Princeton 2 in. x 4 in. x 95-1/2 in. Routed Top Rail
_____	285638	Princeton 2 in. x 4 in. x 95-1/2 in. Routed Bottom Rail with Steel
_____	319048	Picket 7/8 in. x 1-1/2 in. x 48 in.
_____	71413	1-5/8 in. EZ Set Post Brackets (pair with hardware - optional)

Note: 2" x 4" = 1-3/4" x 3-1/2"

A TOP RAIL PALLET QUANTITY = 138
 2" x 4" x 95-1/2"

B PICKETS PALLET QUANTITY = 1000
 28 pieces of 7/8" x 1-1/2" x 48"

C BOTTOM RAIL
 PALLET QUANTITY = 138
 2" x 4" x 95-1/2"
 Includes steel channel.

D POST PALLET QUANTITY = 60
 4" x 4" x 84"

Racks up to 10 degrees



**MEETS
POOL
CODE**

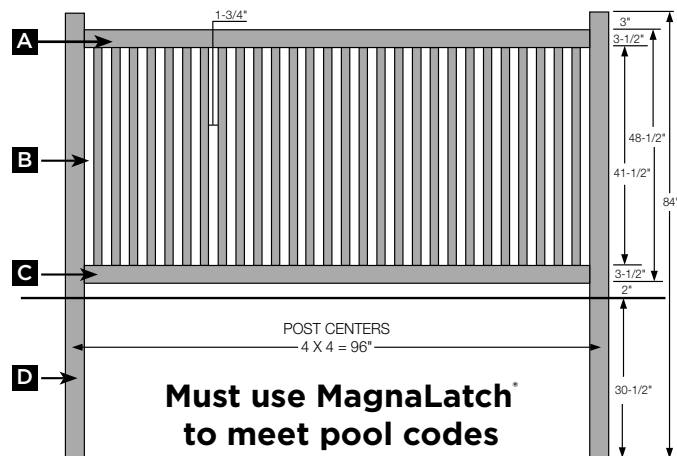

For Almond, add (AL) to item number.

Note: Mixed color sections must be ordered as components; pricing will be higher than standard sections.

QUANTITY	PRODUCT NUMBER	DESCRIPTION
FENCE SECTIONS		
_____	205758	Princeton Fence Section (5 ft. x 8 ft.)

Note: Fence section includes A, B, C, D and section hardware. Post and caps sold separately.

5 IN. X 5 IN. POSTS		
_____	52111	Corner Post 5 in. x 5 in. x 96 in.
_____	52112	Line Post 5 in. x 5 in. x 96 in.
_____	52113	End Post 5 in. x 5 in. x 96 in.
_____	539096	Blank Post 5 in. x 5 in. x 96 in.

POST CAPS		
_____	70493	Ball Cap 5 in. x 5 in.
_____	70416	Gothic Cap Ext 5 in. x 5 in.
_____	70417	Flat Cap Int 5 in. x 5 in.
_____	70418	Flat Cap Ext 5 in. x 5 in.
_____	70427	New England Cap Ext 5 in. x 5 in.

GATES (hardware ordered separately)		
_____	42717	Gate Kit (builds up to 50 in. wide gate)
_____	70029	Gate Extension Kit (builds to 72 in. wide gate) gate kit must also be ordered
_____	437041	Princeton Preassembled Gate 50 in. Wide
_____	70095	Aluminum 5 in. x 5 in. x 94 in. Gate Post Stiffener
_____	27635	Drop Pin Kit
_____	27742	5 ft. to 6 ft. Height Gate Hardware (self-closing hinges and latch)
_____	27745	Deluxe Key Entry Nylon Gate Hardware (5 ft. and 6 ft. height fence)
_____	27752	Plus Key Entry Nylon Gate Hardware (5 ft. and 6 ft. height fence)
_____	27747	LokkLatch Magnetic Gate Hardware (5 ft. and 6 ft. height fence)
_____	27731	Standard Stainless Steel Gate Hardware Pebble Black Finish

Note: Gate kits include (2) 2-1/2 in. x 4 in. up-rights, caps and screws. Rails and pickets ordered separately.

OPTIONAL/EXTRA MATERIAL		
_____	70292	Aluminum Reinforcement Channel x 92 in. or 2 in. x 4 in. (optional)
_____	70092	Steel Reinforcement Channel x 92 in. for 2 in. x 4 in. (required for top rail of WindZone system)
_____	285618	Princeton 2 in. x 4 in. x 95-1/2 in. Routed Top Rail
_____	285638	Princeton 2 in. x 4 in. x 95-1/2 in. Routed Bottom Rail with Steel
_____	285718	Princeton 2 in. x 4 in. x 95-1/2 in. Routed Mid Rail
_____	319060	Picket 7/8 in. x 1-1/2 in. x 59-5/8 in.
_____	71414	2 in. EZ Set Post Brackets (pair with hardware - optional)

Note: Attach Mid Rail with supplied hardware.

Note: 2" x 4" = 1-3/4" x 3-1/2"

- A TOP RAIL** PALLET QUANTITY = 138
2" x 4" x 95-1/2"
- B MID RAIL** PALLET QUANTITY = 138
2" x 4" x 95-1/2"
- C PICKETS** PALLET QUANTITY = 1000
28 pieces of 7/8" x 1-1/2" x 59-5/8"
- D BOTTOM RAIL**
PALLET QUANTITY = 138
2" x 4" x 95-1/2"
Includes steel channel.
- E POST** PALLET QUANTITY = 48
5" x 5" x 96"

Racks up to 5 degrees



**MEETS
POOL
CODE**

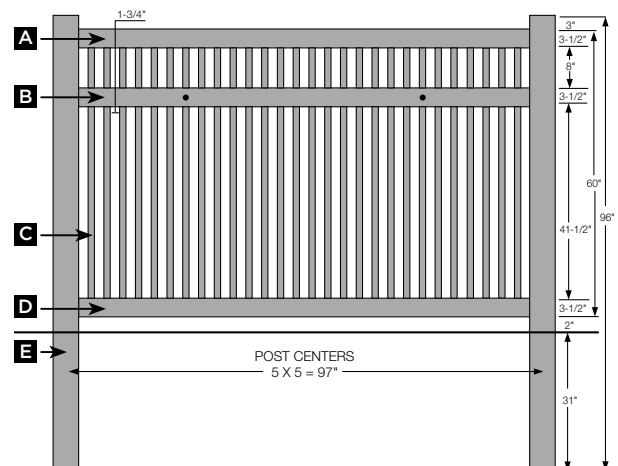

For Almond, add (AL) to item number.

Note: Mixed color sections must be ordered as components; pricing will be higher than standard sections.

QUANTITY	PRODUCT NUMBER	DESCRIPTION
----------	----------------	-------------

FENCE SECTIONS

205768 Princeton Fence Section (6 ft. x 8 ft.)

Note: Fence section includes A, B, C, D and section hardware. Post and caps sold separately.

5 IN. X 5 IN. POSTS

67491 Corner Post 5 in. x 5 in. x 107 in.
 67492 Line Post 5 in. x 5 in. x 107 in.
 67493 End Post 5 in. x 5 in. x 107 in.
 679108 Blank Post Heavy Wall 5 in. x 5 in. x 107 in.

POST CAPS

70493 Ball Cap 5 in. x 5 in.
 70416 Gothic Cap Ext 5 in. x 5 in.
 70418 Flat Cap Ext 5 in. x 5 in.
 70427 New England Cap Ext 5 in. x 5 in.

GATES (hardware ordered separately)

42718 Gate Kit (builds up to 50 in. wide gate)
 70029 Gate Extension Kit (builds to 72 in. wide gate) gate kit must also be ordered
 437047 Princeton Preassembled Gate 50 in. Wide
 70106 Aluminum 5 in. x 5 in. x 106 in. Gate Post Stiffener
 27635 Drop Pin Kit
 27742 5 ft. to 6 ft. Height Gate Hardware (self-closing hinges and latch)
 27745 Deluxe Key Entry Nylon Gate Hardware (5 ft. and 6 ft. height fence)
 27752 Plus Key Entry Nylon Gate Hardware (5 ft. and 6 ft. height fence)
 27747 LokaLatch Magnetic Gate Hardware (5 ft. and 6 ft. height fence)
 27731 Standard Stainless Steel Gate Hardware Pebble Black Finish

Note: Gate kits include (2) 2-1/2 in. x 4 in. up-rights, caps and screws. Rails and pickets ordered separately.

OPTIONAL/EXTRA MATERIAL

70292 Aluminum Reinforcement Channel x 92 in. or 2 in. x 4 in. (optional)
 70092 Steel Reinforcement Channel x 92 in. for 2 in. x 4 in. (required for top rail of WindZone system)
 285618 Princeton 2 in. x 4 in. x 95-1/2 in. Routed Top Rail
 285638 Princeton 2 in. x 4 in. x 95-1/2 in. Routed Bottom Rail with Steel
 285718 Princeton 2 in. x 4 in. x 95-1/2 in. Routed Mid Rail
 319072 Picket 7/8 in. x 1-1/2 in. x 71-5/8 in.
 71414 2 in. EZ Set Post Brackets (pair with hardware - optional)

Note: Attach Mid Rail with supplied hardware.

Note: 2" x 4" = 1-3/4" x 3-1/2"

- A TOP RAIL** PALLET QUANTITY = 138
2" x 4" x 95-1/2"
- B MID RAIL** PALLET QUANTITY = 138
2" x 4" x 95-1/2"
- C PICKETS** PALLET QUANTITY = 1000
28 pieces of 7/8" x 1-1/2" x 71-5/8"
- D BOTTOM RAIL**
PALLET QUANTITY = 138
2" x 4" x 95-1/2"
Includes steel channel.
- E POST** PALLET QUANTITY = 48
5" x 5" x 107"

Racks up to 5 degrees



**MEETS
POOL
CODE**

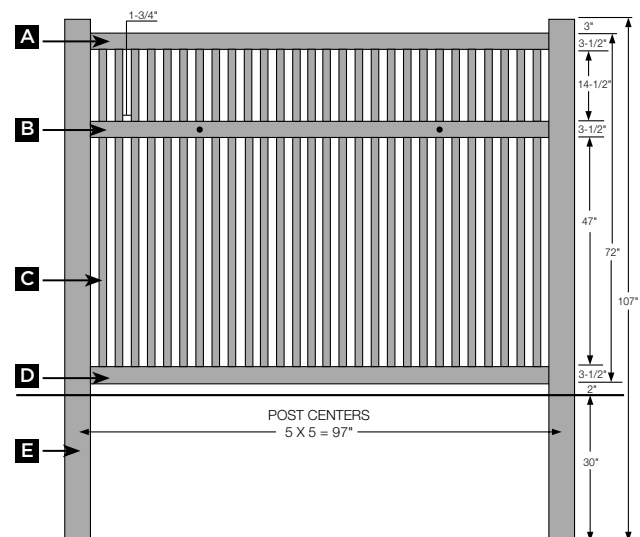

**Contemporary
Victorian**

4 ft. High / 8 ft. Wide

Select one of the available colors
 Almond White

For Almond, add (AL) to item number.

Note: Mixed color sections must be ordered as components; pricing will be higher than standard sections.

QUANTITY	PRODUCT NUMBER	DESCRIPTION
FENCE SECTIONS		
_____	207948	Victorian Fence Section (4 ft. x 8 ft.)

Note: Fence section includes A, B, C and section hardware. Post and caps sold separately.

4 IN. X 4 IN. POSTS		
_____	64471	Corner Post 4 in. x 4 in. x 84 in.
_____	64472	Line Post 4 in. x 4 in. x 84 in.
_____	64473	End Post 4 in. x 4 in. x 84 in.
_____	649084	Blank Post 4 in. x 4 in. x 84 in.

POST CAPS		
_____	70409	Gothic Cap Ext 4 in. x 4 in.
_____	70411	Flat Cap Int 4 in. x 4 in.
_____	70492	Ball Cap 4 in. x 4 in.
_____	70414	Flat Cap Ext 4 in. x 4 in.
_____	70426	New England Cap 4 in. x 4 in.

GATES (hardware ordered separately)		
_____	42716	Gate Kit (builds up to 50 in. wide gate)
_____	70029	Gate Extension Kit (builds to 72 in. wide gate) gate kit must also be ordered
_____	437036	Preassembled Gate 50 in. Wide
_____	70082	Aluminum 4 in. x 4 in. x 82 in. Gate Post Stiffener
_____	27635	Drop Pin Kit
_____	27741	3 ft. to 4 ft. Height Gate Hardware (self-closing hinges and latch)
_____	27744	Deluxe Key Entry Nylon Gate Hardware (3 ft. and 4 ft. height fence)
_____	27751	Plus Key Entry Nylon Gate Hardware (3 ft. and 4 ft. height fence)
_____	27731	Standard Stainless Steel Gate Hardware Pebble Black Finish

Note: Gate kits include (2) 2-1/2 in. x 4 in. up-rights, caps and screws. Rails and pickets ordered separately.

OPTIONAL/EXTRA MATERIAL		
_____	70292	Aluminum Reinforcement Channel x 92 in. or 2 in. x 4 in. (optional)
_____	70092	Steel Reinforcement Channel x 92 in. for 2 in. x 4 in. (required for top rail of WindZone system)
_____	287818	Victorian 2 in. x 4 in. x 95-1/2 in. Routed Top Rail
_____	287838	Victorian 2 in. x 4 in. x 95-1/2 in. Routed Bottom Rail with Steel
_____	319048	Picket 7/8 in. x 1-1/2 in. x 48 in.
_____	71413	1-5/8 in. EZ Set Post Brackets (pair with hardware - optional)

Note: 2" x 4" = 1-3/4" x 3-1/2"

- A TOP RAIL** PALLET QUANTITY = 138
2" x 4" x 95-1/2"
- B PICKETS** PALLET QUANTITY = 1000
17 pieces of 7/8" x 1-1/2" x 48"
- C BOTTOM RAIL**
PALLET QUANTITY = 138
2" x 4" x 95-1/2"
Includes steel channel
- D POST** PALLET QUANTITY = 60
4" x 4" x 84"

Racks up to 10 degrees

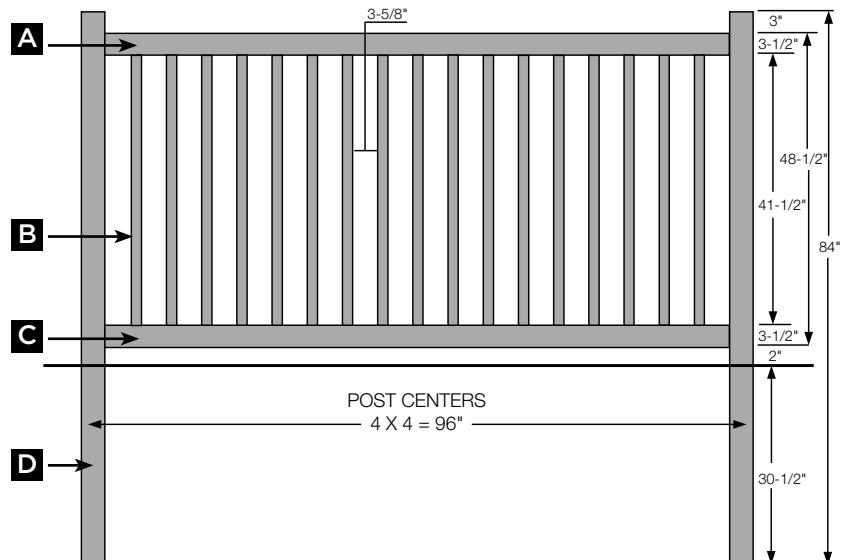

For Almond, add (AL) to item number.

Note: Mixed color sections must be ordered as components; pricing will be higher than standard sections.

QUANTITY	PRODUCT NUMBER	DESCRIPTION
FENCE SECTIONS		
_____	207958	Victorian Fence Section (5 ft. x 8 ft.)

Note: Fence section includes A, B, C, D and section hardware. Post and caps sold separately.

5 IN. X 5 IN. POSTS		
_____	52111	Corner Post 5 in. x 5 in. x 96 in.
_____	52112	Line Post 5 in. x 5 in. x 96 in.
_____	52113	End Post 5 in. x 5 in. x 96 in.
_____	539096	Blank Post 5 in. x 5 in. x 96 in.

POST CAPS		
_____	70493	Ball Cap 5 in. x 5 in.
_____	70416	Gothic Cap Ext 5 in. x 5 in.
_____	70417	Flat Cap Int 5 in. x 5 in.
_____	70418	Flat Cap Ext 5 in. x 5 in.
_____	70427	New England Cap Ext 5 in. x 5 in.

GATES (hardware ordered separately)		
_____	42717	Gate Kit (builds up to 50 in. wide gate)
_____	70029	Gate Extension Kit (builds to 72 in. wide gate) gate kit must also be ordered
_____	437042	Preassembled Gate 50 in. Wide
_____	70095	Aluminum 5 in. x 5 in. x 94 in. Gate Post Stiffener
_____	27635	Drop Pin Kit
_____	27742	5 ft. to 6 ft. Height Gate Hardware (self-closing hinges and latch)
_____	27745	Deluxe Key Entry Nylon Gate Hardware (5 ft. and 6 ft. height fence)
_____	27752	Plus Key Entry Nylon Gate Hardware (5 ft. and 6 ft. height fence)
_____	27747	LokkLatch Magnetic Gate Hardware (5 ft. and 6 ft. height fence)
_____	27731	Standard Stainless Steel Gate Hardware Pebble Black Finish

Note: Gate kits include (2) 2-1/2 in. x 4 in. up-rights, caps and screws. Rails and pickets ordered separately.

OPTIONAL/EXTRA MATERIAL		
_____	70292	Aluminum Reinforcement Channel x 92 in. or 2 in. x 4 in. (optional)
_____	70092	Steel Reinforcement Channel x 92 in. for 2 in. x 4 in. (required for top rail of WindZone system)
_____	287818	Victorian 2 in. x 4 in. x 95-1/2 in. Routed Top Rail
_____	287838	Victorian 2 in. x 4 in. x 95-1/2 in. Routed Bottom Rail with Steel
_____	287918	Victorian 2 in. x 4 in. x 95-1/2 in. Routed Mid Rail
_____	319060	Picket 7/8 in. x 1-1/2 in. x 59-5/8 in.
_____	71414	2 in. EZ Set Post Brackets (pair with hardware - optional)

Note: Attach Mid Rail with supplied hardware.

Note: 2" x 4" = 1-3/4" x 3-1/2"

- A TOP RAIL** PALLET QUANTITY = 138
2" x 4" x 95-1/2"
- B MID RAIL** PALLET QUANTITY = 138
2" x 4" x 95-1/2"
- C PICKETS** PALLET QUANTITY = 1000
17 pieces of 7/8" x 1-1/2" x 59-5/8"
- D BOTTOM RAIL**
PALLET QUANTITY = 138
2" x 4" x 95-1/2"
Includes steel channel.
- E POST** PALLET QUANTITY = 48
5" x 5" x 96"

Racks up to 5 degrees

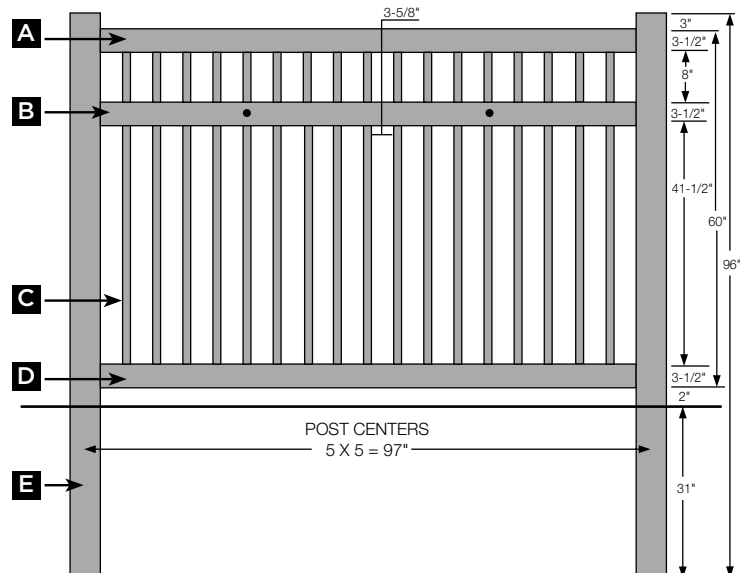

For Almond, add (AL) to item number.

Note: Mixed color sections must be ordered as components; pricing will be higher than standard sections.

QUANTITY	PRODUCT NUMBER	DESCRIPTION
FENCE SECTIONS		
_____	207968	Victorian Fence Section (6 ft. x 8 ft.)
<i>Note: Fence section includes A, B, C, D and section hardware. Post and caps sold separately.</i>		
5 IN. X 5 IN. POSTS		
_____	67491	Corner Post 5 in. x 5 in. x 107 in.
_____	67492	Line Post 5 in. x 5 in. x 107 in.
_____	67493	End Post 5 in. x 5 in. x 107 in.
_____	679108	Blank Post Heavy Wall 5 in. x 5 in. x 107 in.
POST CAPS		
_____	70493	Ball Cap 5 in. x 5 in.
_____	70416	Gothic Cap Ext 5 in. x 5 in.
_____	70418	Flat Cap Ext 5 in. x 5 in.
_____	70427	New England Cap Ext 5 in. x 5 in.
GATES (hardware ordered separately)		
_____	42718	Gate Kit (builds up to 50 in. wide gate)
_____	70029	Gate Extension Kit (builds to 72 in. wide gate) gate kit must also be ordered
_____	437048	Preassembled Gate 50 in. Wide
_____	70106	Aluminum 5 in. x 5 in. x 106 in. Gate Post Stiffener
_____	27635	Drop Pin Kit
_____	27742	5 ft. to 6 ft. Height Gate Hardware (self-closing hinges and latch)
_____	27745	Deluxe Key Entry Nylon Gate Hardware (5 ft. and 6 ft. height fence)
_____	27752	Plus Key Entry Nylon Gate Hardware (5 ft. and 6 ft. height fence)
_____	27747	LokkLatch Magnetic Gate Hardware (5 ft. and 6 ft. height fence)
_____	27731	Standard Stainless Steel Gate Hardware Pebble Black Finish
<i>Note: Gate kits include (2) 2-1/2 in. x 4 in. up-rights, caps and screws. Rails and pickets ordered separately.</i>		
OPTIONAL/EXTRA MATERIAL		
_____	70292	Aluminum Reinforcement Channel x 92 in. or 2 in. x 4 in. (optional)
_____	70092	Steel Reinforcement Channel x 92 in. for 2 in. x 4 in. (required for top rail of WindZone system)
_____	287818	Victorian 2 in. x 4 in. x 95-1/2 in. Routed Top Rail
_____	287838	Victorian 2 in. x 4 in. x 95-1/2 in. Routed Bottom Rail with Steel
_____	287918	Victorian 2 in. x 4 in. x 95-1/2 in. Routed Mid Rail
_____	319072	Picket 7/8 in. x 1-1/2 in. x 71-5/8 in.
_____	71414	2 in. EZ Set Post Brackets (pair with hardware - optional)

Note: Attach Mid Rail with supplied hardware.

Note: 2" x 4" = 1-3/4" x 3-1/2"

- A TOP RAIL** PALLET QUANTITY = 138
2" x 4" x 95-1/2"
- B MID RAIL** PALLET QUANTITY = 138
2" x 4" x 95-1/2"
- C PICKETS** PALLET QUANTITY = 1000
17 pieces of 7/8" x 1-1/2" x 71-5/8"
- D BOTTOM RAIL**
PALLET QUANTITY = 138
2" x 4" x 95-1/2"
Includes steel channel.
- E POST** PALLET QUANTITY = 48
5" x 5" x 107"

Racks up to 5 degrees

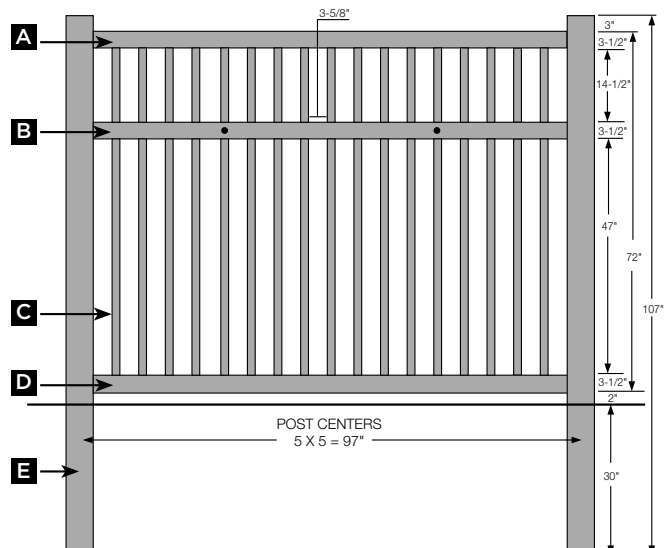

For Almond, add (AL) to item number.

Note: Mixed color sections must be ordered as components; pricing will be higher than standard sections.

QUANTITY	PRODUCT NUMBER	DESCRIPTION
FENCE SECTIONS		
_____	22023	Manchester Fence Section (3 ft. x 8 ft.)

Note: Fence Section includes A, B, C and section hardware. Post and caps sold separately.

5 IN. X 5 IN. POSTS		
_____	54021	Manchester Corner Post 5 in. x 5 in. x 72 in.
_____	54022	Manchester Line Post 5 in. x 5 in. x 72 in.
_____	54023	Manchester End Post 5 in. x 5 in. x 72 in.
_____	539072	Blank Post 5 in. x 5 in. x 72 in.

POST CAPS		
_____	70416	Gothic Cap Ext 5 in. x 5 in.
_____	70417	Flat Cap Int 5 in. x 5 in.
_____	70493	Ball Cap 5 in. x 5 in.
_____	70418	Flat Cap Ext 5 in. x 5 in.
_____	70427	New England Cap Ext 5 in. x 5 in.

GATES (hardware ordered separately)		
_____	42711	Manchester Gate Kit (builds up to 50 in. wide gate)
_____	437024	Manchester Preamsembled Gate 50 in. Wide
_____	70095	Aluminum 5 in. x 5 in. x 94 in. Gate Post Stiffener
_____	27635	Drop Pin Kit
_____	27742	5 ft. to 6 ft. Height Gate Hardware (self-closing hinges and latch)
_____	27747	LokkLatch Magnetic Gate Hardware (5 ft. and 6 ft. height fence)
_____	27745	Deluxe Key Entry Nylon Gate Hardware (5 ft. and 6 ft. height fence)
_____	27752	Plus Key Entry Nylon Gate Hardware (5 ft. and 6 ft. height fence)
_____	27731	Standard Stainless Steel Gate Hardware Pebble Black Finish

Note: Gate kits include (2) 2-1/2 in. x 4 in. up-rights, caps and screws. Rails and pickets ordered separately.

OPTIONAL/EXTRA MATERIAL		
_____	70090	Steel Reinforcement Channel x 92 in. for 2 in. x 6 in. Rail
_____	60783P	Lock Rings (order 2 per rail) Qty: 24
_____	286528	2 in. x 6 in. x 94-1/2 in. Routed Bottom Rail with Steel
_____	290564	2 in. x 3-1/2 in. x 95 in. Routed Mid Rail
_____	388032	Picket 1-1/2 in. x 1-1/2 in. x 31-3/4 in. with Pointed Cap
_____	71414	2 in. EZ Set Post Brackets (pair with hardware - optional)

- A MID RAIL**
 PALLET QUANTITY = 120
 2" x 3 1/2" x 95"
- B PICKETS (with caps attached)**
 PALLET QUANTITY = 300
 29 pieces of 1-1/2" x 1-1/2" x 31-3/4"
- PICKET CAPS**
 1-1/2" x 1-1/2" x 3/4"
 Pointed picket caps.
- C BOTTOM RAIL**
 PALLET QUANTITY = 84
 2" x 6" x 94-1/2" Ribbed.
 Includes steel channel.
- D POST**
 PALLET QUANTITY = 48
 5" x 5" x 72"

Racks up to 5 degrees

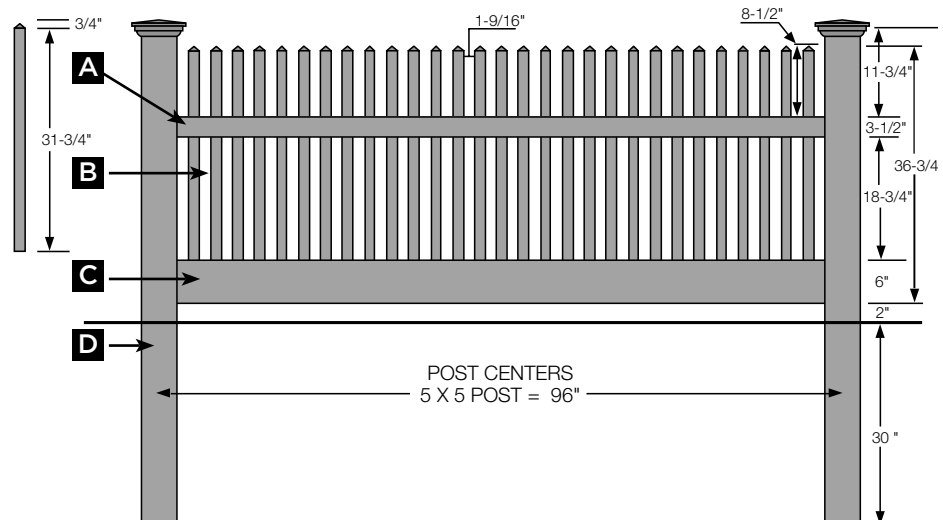

For Almond, add (AL) to item number.

Note: Mixed color sections must be ordered as components; pricing will be higher than standard sections.

QUANTITY	PRODUCT NUMBER	DESCRIPTION
FENCE SECTIONS		
_____	22024	Manchester Fence Section (4 ft. x 8 ft.)
<i>Note: Fence Section includes A, B, C and section hardware. Post and caps sold separately.</i>		
5 IN. X 5 IN. POSTS		
_____	54041	Manchester Corner Post 5 in. x 5 in. x 84 in.
_____	54042	Manchester Line Post 5 in. x 5 in. x 84 in.
_____	54043	Manchester End Post 5 in. x 5 in. x 84 in.
_____	539084	Blank Post 5 in. x 5 in. x 84 in.
POST CAPS		
_____	70416	Gothic Cap Ext 5 in. x 5 in.
_____	70417	Flat Cap Int 5 in. x 5 in.
_____	70493	Ball Cap 5 in. x 5 in.
_____	70418	Flat Cap Ext 5 in. x 5 in.
_____	70427	New England Cap Ext 5 in. x 5 in.
GATES (hardware ordered separately)		
_____	42713	Manchester Gate Kit (builds up to 50 in. wide gate)
_____	437025	Manchester Preambled Gate 50 in. Wide
_____	70095	Aluminum 5 in. x 5 in. x 94 in. Gate Post Stiffener
_____	27635	Drop Pin Kit
_____	27742	5 ft. to 6 ft. Height Gate Hardware (self-closing hinges and latch)
_____	27745	Deluxe Key Entry Nylon Gate Hardware (5 ft. and 6 ft. height fence)
_____	27752	Plus Key Entry Nylon Gate Hardware (5 ft. and 6 ft. height fence)
_____	27747	LokkLatch Magnetic Gate Hardware (5 ft. and 6 ft. height fence)
_____	27731	Standard Stainless Steel Gate Hardware Pebble Black Finish
<i>Note: Gate kits include (2) 2-1/2 in. x 4 in. up-rights, caps and screws. Rails and pickets ordered separately.</i>		
OPTIONAL/EXTRA MATERIAL		
_____	70090	Steel Reinforcement Channel x 92 in. for 2 in. x 6 in. Rail
_____	60783P	Lock Rings (order 2 per rail) Qty: 24
_____	286528	2 in. x 6 in. x 94-1/2 in. Routed Bottom Rail with Steel
_____	290564	2 in. x 3-1/2 in. x 95 in. Routed Mid Rail
_____	388044	Picket 1-1/2 in. x 1-1/2 in. x 43-3/4 in. with Pointed Cap
_____	71414	2 in. EZ Set Post Brackets (pair with hardware - optional)

- A MID RAIL**
 PALLET QUANTITY = 120
 2" x 3 1/2" x 95"
- B PICKETS (with caps attached)**
 PALLET QUANTITY = 300
 29 pieces of 1-1/2" x 1-1/2" x 43-3/4"
- PICKET CAPS**
 1-1/2" x 1-1/2" x 3/4"
 Pointed picket caps.
- C BOTTOM RAIL**
 PALLET QUANTITY = 84
 2" x 6" x 94-1/2" Ribbed.
 Includes steel channel.
- D POST** PALLET QUANTITY = 48
 5" x 5" x 84"

Racks up to 5 degrees

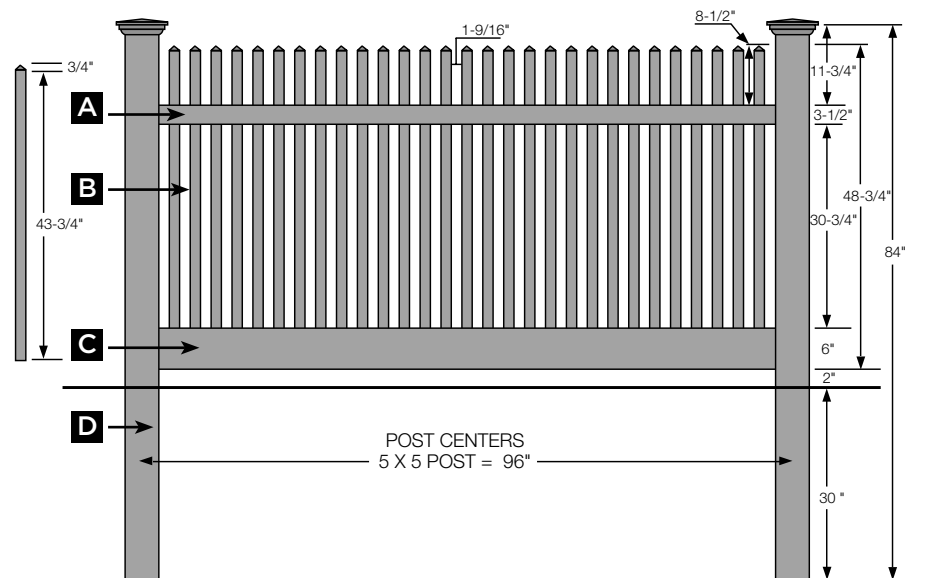

For Almond, add (AL) to item number.

Note: Mixed color sections must be ordered as components; pricing will be higher than standard sections.

QUANTITY	PRODUCT NUMBER	DESCRIPTION
FENCE SECTIONS		
_____	22033	Manchester Concave Fence Section (3 to 3-1/2 ft. x 8 ft.)

Note: Fence Section includes A, B, C and section hardware. Post and caps sold separately.

5 IN. X 5 IN. POSTS		
_____	54031	Manchester Corner Post 5 in. x 5 in. x 78 in.
_____	54032	Manchester Line Post 5 in. x 5 in. x 78 in.
_____	54033	Manchester End Post 5 in. x 5 in. x 78 in.
_____	539078	Blank Post 5 in. x 5 in. x 78 in.

POST CAPS		
_____	70416	Gothic Cap Ext 5 in. x 5 in.
_____	70417	Flat Cap Int 5 in. x 5 in.
_____	70493	Ball Cap 5 in. x 5 in.
_____	70418	Flat Cap Ext 5 in. x 5 in.
_____	70427	New England Cap Ext 5 in. x 5 in.

GATES (hardware ordered separately)		
_____	42712	Manchester Gate Kit Scalloped (builds up to 50 in. wide gate)
_____	70095	Aluminum 5 in. x 5 in. x 94 in. Gate Post Stiffener
_____	27635	Drop Pin Kit
_____	27742	5 ft. to 6 ft. Height Gate Hardware (self-closing hinges and latch)
_____	27745	Deluxe Key Entry Nylon Gate Hardware (5 ft. and 6 ft. height fence)
_____	27752	Plus Key Entry Nylon Gate Hardware (5 ft. and 6 ft. height fence)
_____	27747	LokkLatch Magnetic Gate Hardware (5 ft. and 6 ft. height fence)
_____	27731	Standard Stainless Steel Gate Hardware Pebble Black Finish

Note: Gate kits include (2) 2-1/2 in. x 4 in. up-rights, caps and screws. Rails and pickets ordered separately.

OPTIONAL/EXTRA MATERIAL		
_____	388038	Picket 1-1/2 in. x 1-1/2 in. x 37-3/4 in. with Pointed Cap
_____	388032	Picket 1-1/2 in. x 1-1/2 in. x 31-3/4 in. with Pointed Cap
_____	60783P	Lock Rings (order 2 per rail) Qty: 24
_____	70090	Steel Reinforcement Channel x 92 in. for 2 in. x 6 in. Rail
_____	286528	2 in. x 6 in. x 94-1/2 in. Routed Bottom Rail with Steel
_____	290564	2 in. x 3-1/2 in. x 95 in. Routed Mid Rail
_____	71414	2 in. EZ Set Post Brackets (pair with hardware - optional)

A MID RAIL
 PALLET QUANTITY = 120
 2" x 3 1/2" x 95"

B PICKETS (with caps attached)
 21 pieces of
 1-1/2" x 1-1/2" x 31-3/4"
 8 pieces of
 1-1/2" x 1-1/2" x 37-3/4"

PICKET CAPS
 1-1/2" x 1-1/2" x 3/4"
 Pointed picket caps.

C BOTTOM RAIL
 PALLET QUANTITY = 84
 2" x 6" x 94-1/2" Ribbed.
 Includes steel channel.

D POST
 PALLET QUANTITY = 48
 5" x 5" x 78"

Racks up to 5 degrees

LAST 4 PICKETS ON EACH END OF SECTION SUPPLIED 37-3/4" WITH CAPS ATTACHED. FIELD CUT TO ACHIEVE DESIRED SCALLOP HOLD IN RAIL WITH BULLET CLIP OR CRIMP.

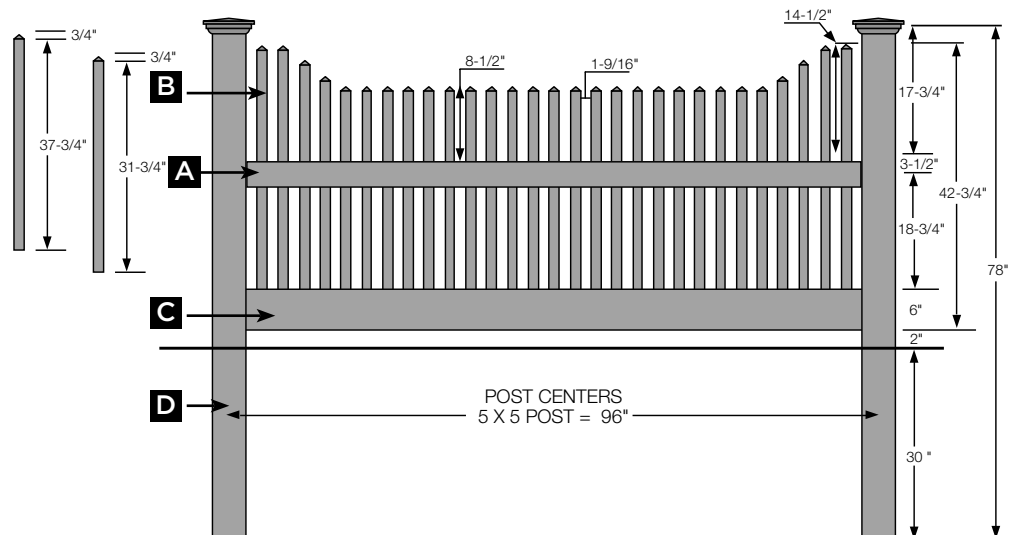

For Almond, add (AL) to item number.

Note: Mixed color sections must be ordered as components; pricing will be higher than standard sections.

QUANTITY	PRODUCT NUMBER	DESCRIPTION
FENCE SECTIONS		
_____	22034	Manchester Concave Fence Section (4 to 4-1/2 ft. x 8 ft.)
<i>Note: Fence Section includes A, B, C and section hardware. Post and caps sold separately.</i>		
5 IN. X 5 IN. POSTS		
_____	54051	Manchester Corner Post 5 in. x 5 in. x 90 in.
_____	54052	Manchester Line Post 5 in. x 5 in. x 90 in.
_____	54053	Manchester End Post 5 in. x 5 in. x 90 in.
_____	539090	Blank Post 5 in. x 5 in. x 90 in.
POST CAPS		
_____	70416	Gothic Cap Ext 5 in. x 5 in.
_____	70417	Flat Cap Int 5 in. x 5 in.
_____	70493	Ball Cap 5 in. x 5 in.
_____	70418	Flat Cap Ext 5 in. x 5 in.
_____	70427	New England Cap Ext 5 in. x 5 in.
GATES (hardware ordered separately)		
_____	42714	Manchester Gate Kit Scalloped (builds up to 50 in. wide gate)
_____	70095	Aluminum 5 in. x 5 in. x 94 in. Gate Post Stiffener
_____	27635	Drop Pin Kit
_____	27742	5 ft. to 6 ft. Height Gate Hardware (self-closing hinges and latch)
_____	27745	Deluxe Key Entry Nylon Gate Hardware (5 ft. and 6 ft. height fence)
_____	27752	Plus Key Entry Nylon Gate Hardware (5 ft. and 6 ft. height fence)
_____	27747	LokkLatch Magnetic Gate Hardware (5 ft. and 6 ft. height fence)
_____	27731	Standard Stainless Steel Gate Hardware Pebble Black Finish
<i>Note: Gate kits include (2) 2-1/2 in. x 4 in. up-rights, caps and screws. Rails and pickets ordered separately.</i>		
OPTIONAL/EXTRA MATERIAL		
_____	388050	Picket 1-1/2 in. x 1-1/2 in. x 49-3/4 in. with Pointed Cap
_____	388044	Picket 1-1/2 in. x 1-1/2 in. x 43-3/4 in. with Pointed Cap
_____	60783P	Lock Rings (order 2 per rail) Qty: 24
_____	70090	Steel Reinforcement Channel x 92 in. for 2 in. x 6 in. Rail
_____	286528	2 in. x 6 in. x 94-1/2 in. Routed Bottom Rail with Steel
_____	290564	2 in. x 3-1/2 in. x 95 in. Routed Mid Rail
_____	71414	2 in. EZ Set Post Brackets (pair with hardware - optional)

- A MID RAIL**
 PALLET QUANTITY = 120
 2" x 3 1/2" x 95"
 - B PICKETS**
 (with caps attached)
 21 pickets of
 1-1/2" x 1-1/2" x 43-3/4"
 8 pickets of
 1-1/2" x 1-1/2" x 49-3/4"
 - PICKET CAPS**
 1-1/2" x 1-1/2" x 3/4"
 Pointed picket caps
 - C BOTTOM RAIL**
 PALLET QUANTITY = 84
 2" x 6" x 94-1/2" Ribbed.
 Includes steel channel.
 - D POST**
 PALLET QUANTITY = 48
 5" x 5" x 90"
- Racks up to 5 degrees**

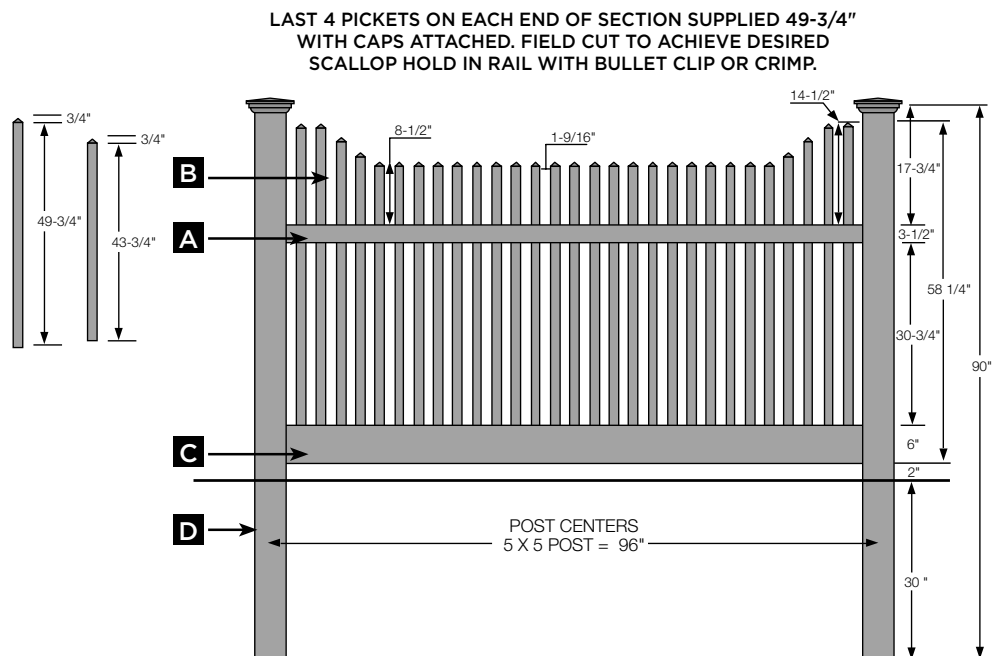

QUANTITY	PRODUCT NUMBER	DESCRIPTION
FENCE SECTIONS		
_____	20323	Cape Cod Fence Section (3 ft. x 6 ft.)
<i>Note: Fence section includes A, B, C and section hardware. Post and caps sold separately.</i>		
4 IN. X 4 IN. POSTS		
_____	64101	T12 Corner Post 4 in. x 4 in. x 64 in.
_____	64102	T12 Line Post 4 in. x 4 in. x 64 in.
_____	64103	T12 End Post 4 in. x 4 in. x 64 in.
_____	649064	Blank Post 4 in. x 4 in. x 64 in.
POST CAPS		
_____	70409	Gothic Cap Ext 4 in. x 4 in.
_____	70411	Flat Cap Int 4 in. x 4 in.
_____	70492	Ball Cap 4 in. x 4 in.
_____	70414	Flat Cap Ext 4 in. x 4 in.
_____	70426	New England Cap 4 in. x 4 in.
GATES (hardware ordered separately)		
_____	42701	T12 Gate Kit (builds up to 50 in. wide gate)
_____	70035	T12 Gate Extension Kit (builds up to 60 in. wide gate) gate kit must also be ordered
_____	437001	Assembled Gate 50 in. Wide
_____	70072	Aluminum 4 in. x 4 in. x 72 in. Gate Post Stiffener
_____	27635	Drop Pin Kit
_____	27741	3 ft. to 4 ft. Height Gate Hardware (self-closing hinges and latch)
_____	27744	Deluxe Key Entry Nylon Gate Hardware (3 ft. and 4 ft. height fence)
_____	27751	Plus Key Entry Nylon Gate Hardware (3 ft. and 4 ft. height fence)
_____	27731	Standard Stainless Steel Gate Hardware Pebble Black Finish
<i>Note: Gate kits include (2) 2-1/2 in. x 4 in. up-rights, caps and screws. Rails and pickets ordered separately.</i>		
OPTIONAL/EXTRA MATERIAL		
_____	28212	T12 2 in. x 4 in. x 71-1/2 in. Drilled Rail
_____	3533000	T12 Picket 7/8 in. x 3 in. x 33 in. with Pointed Cap, Drilled
_____	71413	1-5/8 in. EZ Set Post Brackets (pair with hardware - optional)
_____	70814	12 Picket Hardware Bag

Note: 2" x 4" = 1-3/4" x 3-1/2"

- A TOP RAIL**
 PALLET QUANTITY = 138
 2" x 4" x 71-1/2"
- B PICKETS** (with caps attached)
 PALLET QUANTITY = 576
 12 pickets of 7/8" x 3" x 33"
 Length does not include cap.
- PICKET CAPS**
 12 pieces of 7/8" x 3" x 2"
 Pointed picket caps.
- C BOTTOM RAIL**
 PALLET QUANTITY = 138
 2" x 4" x 71-1/2"
- D POST**
 PALLET QUANTITY = 60
 4" x 4" x 64"

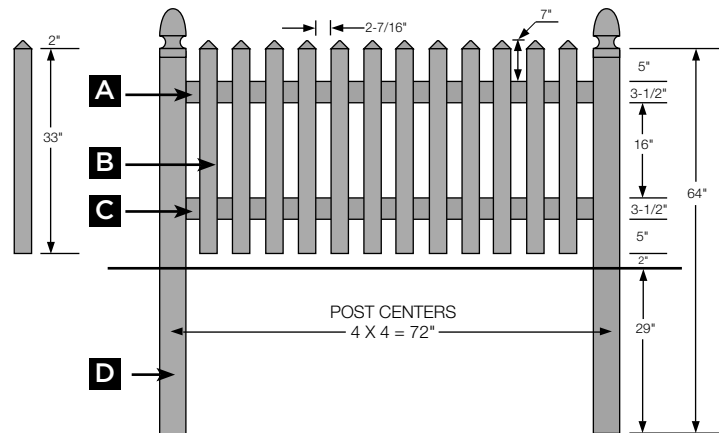

Racks up to 15 degrees

QUANTITY	PRODUCT NUMBER	DESCRIPTION
FENCE SECTIONS		
_____	20324	Cape Cod Fence Section (4 ft. x 6 ft.)
<i>Note: Fence section includes A, B, C and section hardware. Post and caps sold separately.</i>		
4 IN. X 4 IN. POSTS		
_____	64111	T12 Corner Post 4 in. x 4 in. x 75 in.
_____	64112	T12 Line Post 4 in. x 4 in. x 75 in.
_____	64113	T12 End Post 4 in. x 4 in. x 75 in.
_____	649075	Blank Post 4 in. x 4 in. x 75 in.
POST CAPS		
_____	70409	Gothic Cap Ext 4 in. x 4 in.
_____	70411	Flat Cap Int 4 in. x 4 in.
_____	70492	Ball Cap 4 in. x 4 in.
_____	70414	Flat Cap Ext 4 in. x 4 in.
_____	70426	New England Cap 4 in. x 4 in.
GATES (hardware ordered separately)		
_____	42703	T12 Gate Kit (builds up to 50 in. wide gate)
_____	70035	T12 Gate Extension Kit (builds up to 60 in. wide gate) gate kit must also be ordered
_____	437007	Assembled Gate 50 in. Wide
_____	70072	Aluminum 4 in. x 4 in. x 72 in. Gate Post Stiffener
_____	27635	Drop Pin Kit
_____	27741	3 ft. to 4 ft. Height Gate Hardware (self-closing hinges and latch)
_____	27744	Deluxe Key Entry Nylon Gate Hardware (3 ft. and 4 ft. height fence)
_____	27751	Plus Key Entry Nylon Gate Hardware (3 ft. and 4 ft. height fence)
_____	27731	Standard Stainless Steel Gate Hardware Pebble Black Finish
<i>Note: Gate kits include (2) 2-1/2 in. x 4 in. up-rights, caps, and screws. Rails and pickets ordered separately.</i>		
OPTIONAL/EXTRA MATERIAL		
_____	28212	T12 2 in. x 4 in. x 71-1/2 in. Drilled Rail
_____	3545000	T12 Picket 7/8 in. x 3 in. x 45 in. with Pointed Cap, Drilled
_____	71413	1-5/8 in. EZ Set Post Brackets (pair with hardware - optional)
_____	70814	12 Picket Hardware Bag

Note: 2" x 4" = 1-3/4" x 3-1/2"

- A TOP RAIL** PALLET QUANTITY = 138
2" x 4" x 71-1/2"
- B PICKETS** (with caps attached)
PALLET QUANTITY = 576
12 pickets of 7/8" x 3" x 45"
Length does not include cap.
- PICKET CAPS**
12 pieces of 7/8" x 3" x 2"
Pointed picket caps.
- C BOTTOM RAIL**
PALLET QUANTITY = 138
2" x 4" x 71-1/2"
- D POST** PALLET QUANTITY = 60
4" x 4" x 75"

Racks up to 15 degrees

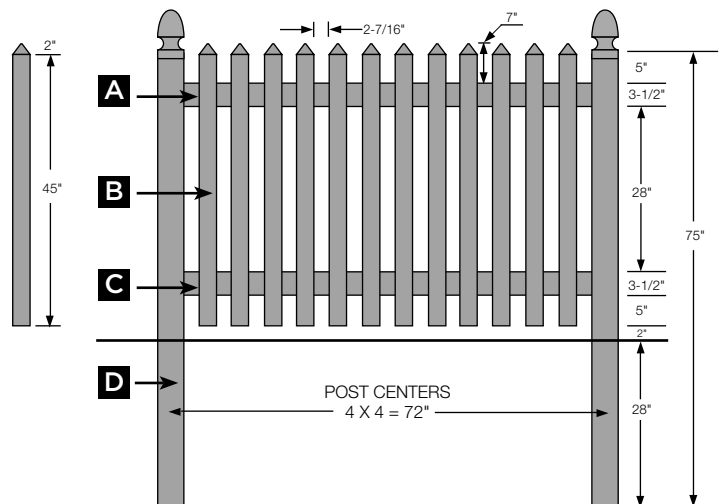

QUANTITY	PRODUCT NUMBER	DESCRIPTION
FENCE SECTIONS		
_____	20343	Cape Cod Concave Fence Section (3 to 3-1/2 ft. x 6 ft.)
<i>Note: Fence section includes A, B, C and section hardware. Post and caps sold separately.</i>		
4 IN. X 4 IN. POSTS		
_____	64121	T12 Concave Corner Post 4 in. x 4 in. x 75 in.
_____	64122	T12 Concave Line Post 4 in. x 4 in. x 75 in.
_____	64123	T12 Concave End Post 4 in. x 4 in. x 75 in.
_____	649075	Blank Post 4 in. x 4 in. x 75 in.
POST CAPS		
_____	70409	Gothic Cap Ext 4 in. x 4 in.
_____	70411	Flat Cap Int 4 in. x 4 in.
_____	70492	Ball Cap 4 in. x 4 in.
_____	70414	Flat Cap Ext 4 in. x 4 in.
_____	70426	New England Cap 4 in. x 4 in.
GATES (hardware ordered separately)		
_____	42702	T12 Concave Gate Kit (builds up to 50 in. wide gate)
_____	70035	T12 Gate Extension Kit (builds up to 60 in. wide gate) gate kit must also be ordered
_____	437004	Concave Assembled Gate 50 in. Wide
_____	70072	Aluminum 4 in. x 4 in. x 72 in. Gate Post Stiffener
_____	27635	Drop Pin Kit
_____	27741	3 ft. to 4 ft. Height Gate Hardware (self-closing hinges and latch)
_____	27744	Deluxe Key Entry Nylon Gate Hardware (3 ft. and 4 ft. height fence)
_____	27751	Plus Key Entry Nylon Gate Hardware (3 ft. and 4 ft. height fence)
_____	27731	Standard Stainless Steel Gate Hardware Pebble Black Finish
<i>Note: Gate kits include (2) 2-1/2 in. x 4 in. up-rights, caps and screws. Rails and pickets ordered separately.</i>		
OPTIONAL/EXTRA MATERIAL		
_____	28212	T12 2 in. x 4 in. x 71-1/2 in. Drilled Rail
_____	34841	T12 Concave Fence Fill Kit 7/8 in. x 3 in. Pickets (12 pc) 3 ft. CC
_____	3764000	T12 Picket 7/8 in. x 3 in. x 64 in. with Pointed Cap, Undrilled
_____	71413	1-5/8 in. EZ Set Post Brackets (pair with hardware - optional)
_____	70814	12 Picket Hardware Bag

Note: 2" x 4" = 1-3/4" x 3-1/2"

A TOP RAIL PALLET QUANTITY = 138

2" x 4" x 71-1/2"

B PICKETS (with caps attached)

12 pickets of 7/8" x 3"

PALLET QUANTITY = 48 Fill Kits

Picket lengths:

#1 = 40" #4 = 34-1/2"

#2 = 37-1/2" #5 = 33-5/8"

#3 = 35-3/4" #6 = 33"

(pickets = 2 of each number)

Length does not include cap.

PICKET CAPS

12 pieces of 7/8" x 3" x 2" Pointed picket caps

C BOTTOM RAIL PALLET QUANTITY = 138

2" x 4" x 71-1/2"

D POST PALLET QUANTITY = 60

4" x 4" x 75"

Racks up to 15 degrees

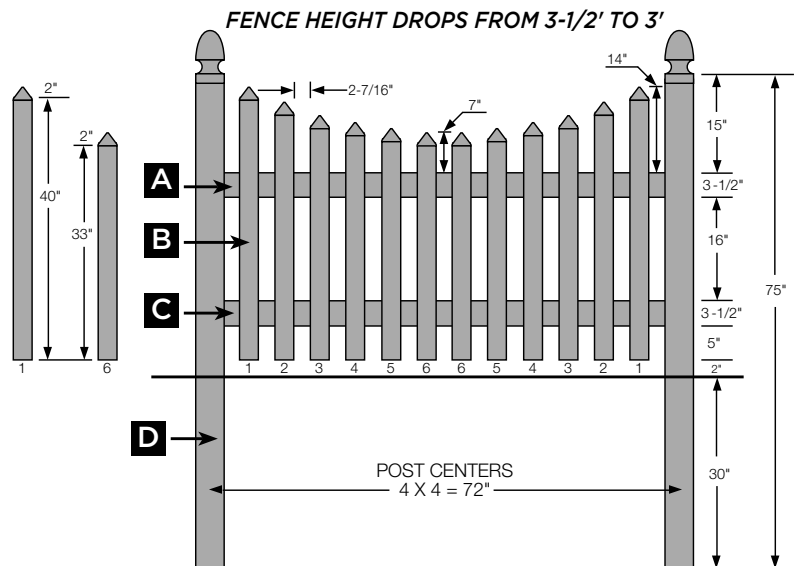

**Traditional
Cape Cod Concave**

4-4.5 ft. High / 6 ft. Wide

Select one of the available colors
 White

QUANTITY	PRODUCT NUMBER	DESCRIPTION
FENCE SECTIONS		
_____	20344	Cape Cod Concave Fence Section (4 to 4-1/2 ft. x 6 ft.)
<i>Note: Fence section includes A, B, C and section hardware. Post and caps sold separately.</i>		
4 IN. X 4 IN. POSTS		
_____	64131	T12 Concave Corner Post 4 in. x 4 in. x 90 in.
_____	64132	T12 Concave Line Post 4 in. x 4 in. x 90 in.
_____	64133	T12 Concave End Post 4 in. x 4 in. x 90 in.
_____	649090	Blank Post 4 in. x 4 in. x 90 in.
POST CAPS		
_____	70409	Gothic Cap Ext 4 in. x 4 in.
_____	70411	Flat Cap Int 4 in. x 4 in.
_____	70492	Ball Cap 4 in. x 4 in.
_____	70414	Flat Cap Ext 4 in. x 4 in.
_____	70426	New England Cap 4 in. x 4 in.
GATES (hardware ordered separately)		
_____	42704	T12 Concave Gate Kit (builds up to 50 in. wide gate)
_____	70035	T12 Gate Extension Kit (builds up to 60 in. wide gate) gate kit must also be ordered
_____	437011	Concave Assembled Gate 50 in. Wide
_____	70082	Aluminum 4 in. x 4 in. x 82 in. Gate Post Stiffener
_____	27635	Drop Pin Kit
_____	27741	3 ft. to 4 ft. Height Gate Hardware (self-closing hinges and latch)
_____	27744	Deluxe Key Entry Nylon Gate Hardware (3 ft. and 4 ft. height fence)
_____	27751	Plus Key Entry Nylon Gate Hardware (3 ft. and 4 ft. height fence)
_____	27731	Standard Stainless Steel Gate Hardware Pebble Black Finish
<i>Note: Gate kits include (2) 2-1/2 in. x 4 in. up-rights, caps, and screws. Rails and pickets ordered separately.</i>		
OPTIONAL/EXTRA MATERIAL		
_____	28212	T12 2 in. x 4 in. x 71-1/2 in. Drilled Rail
_____	34842	T12 Concave Fence Fill Kit 7/8 in. x 3 in. Pickets (12 pc) 4 ft. CC
_____	3764000	T12 Picket 7/8 in. x 3 in. x 64 in. with Pointed Cap, Undrilled
_____	71413	1-5/8 in. EZ Set Post Brackets (pair with hardware - optional)
_____	70814	12 Picket Hardware Bag

Note: 2" x 4" = 1-3/4" x 3-1/2"

A TOP RAIL PALLET QUANTITY = 138
2" x 4" x 71-1/2"

B PICKETS (with caps attached)
12 pickets of 7/8" x 3"
PALLET QUANTITY = 48 Fill Kits
Picket lengths:
#1 = 52" #4 = 46-1/2"
#2 = 49-1/2" #5 = 45-5/8"
#3 = 47-3/4" #6 = 45"
(pickets = 2 of each number)
Length does not include cap.

PICKET CAPS
12 pieces of 7/8" x 3" x 2" Pointed picket caps.

C BOTTOM RAIL PALLET QUANTITY = 138
2" x 4" x 71-1/2"

D POST PALLET QUANTITY = 60
4" x 4" x 90"

Racks up to 15 degrees

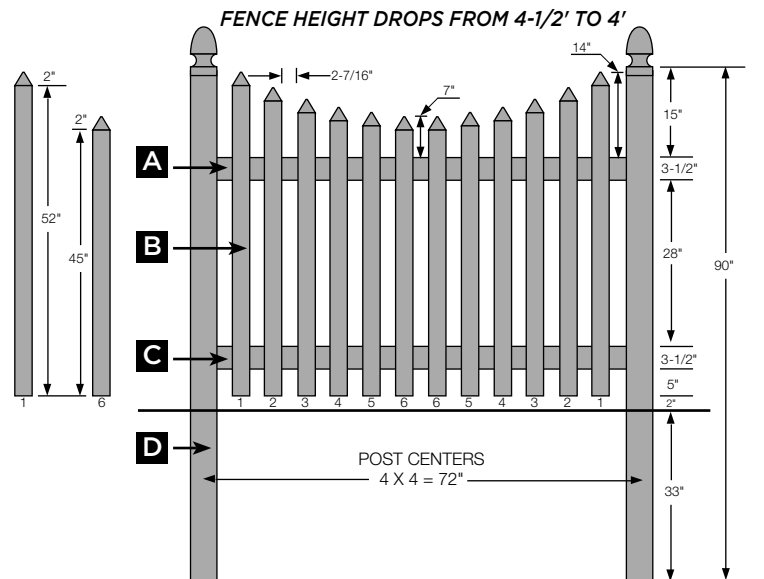

For colors, add color letters to item number: Almond (AL), Clay (C).

Note: Mixed color sections must be ordered as components; pricing will be higher than standard sections.

QUANTITY	PRODUCT NUMBER	DESCRIPTION
FENCE SECTIONS		
_____	20352	Danbury Fence Section (4 ft. x 8 ft.)

Note: Fence section includes A, B, C and section hardware. Post and caps sold separately.

4 IN. X 4 IN. POSTS		
_____	64311	T15 Corner Post 4 in. x 4 in. x 75 in.
_____	64312	T15 Line Post 4 in. x 4 in. x 75 in.
_____	64313	T15 End Post 4 in. x 4 in. x 75 in.
_____	649075	Blank Post 4 in. x 4 in. x 75 in.

POST CAPS		
_____	70409	Gothic Cap Ext 4 in. x 4 in.
_____	70411	Flat Cap Int 4 in. x 4 in.
_____	70492	Ball Cap 4 in. x 4 in.
_____	70414	Flat Cap Ext 4 in. x 4 in.
_____	70426	New England Cap 4 in. x 4 in.

GATES (hardware ordered separately)		
_____	42707	T15 Gate Kit (builds up to 50 in. wide gate)
_____	437018	Danbury Preamsembled Gate 50 in. Wide
_____	70072	Aluminum 4 in. x 4 in. x 72 in. Gate Post Stiffener
_____	27635	Drop Pin Kit
_____	27741	3 ft. to 4 ft. Height Gate Hardware (self-closing hinges and latch)
_____	27744	Deluxe Key Entry Nylon Gate Hardware (3 ft. and 4 ft. height fence)
_____	27751	Plus Key Entry Nylon Gate Hardware (3 ft. and 4 ft. height fence)
_____	27731	Standard Stainless Steel Gate Hardware Pebble Black Finish

Note: Gate kits include (2) 2-1/2 in. x 4 in. up-rights, caps and screws. Rails and pickets ordered separately.

OPTIONAL/EXTRA MATERIAL		
_____	28453	T15 2 in. x 4 in. x 95-1/2 in. Routed Mid Rail
_____	28454	T15 2 in. x 4 in. x 95-1/2 in. Routed Bottom Rail with Steel
_____	4144000	Danbury Picket 7/8 in. x 3 in. x 44 in. with Pointed Cap, Crimped
_____	71413	1-5/8 in. EZ Set Post Brackets (pair with hardware - optional)

Note: 2" x 4" = 1-3/4" x 3-1/2"

- A TOP rail** PALLET QUANTITY = 138
2" x 4" x 95-1/2"
- B PICKETS** (with caps attached)
15 pickets of 7/8" x 3" x 44"
PALLET QUANTITY = 450
Length does not include cap.
- C PICKET CAPS**
15 pieces of 7/8" x 3" x 2"
Pointed picket caps.
- C BOTTOM RAIL**
PALLET QUANTITY = 138
2" x 4" x 95-1/2"
Includes steel channel.
- D POST** PALLET QUANTITY = 60
4" x 4" x 75"

Racks up to 5 degrees

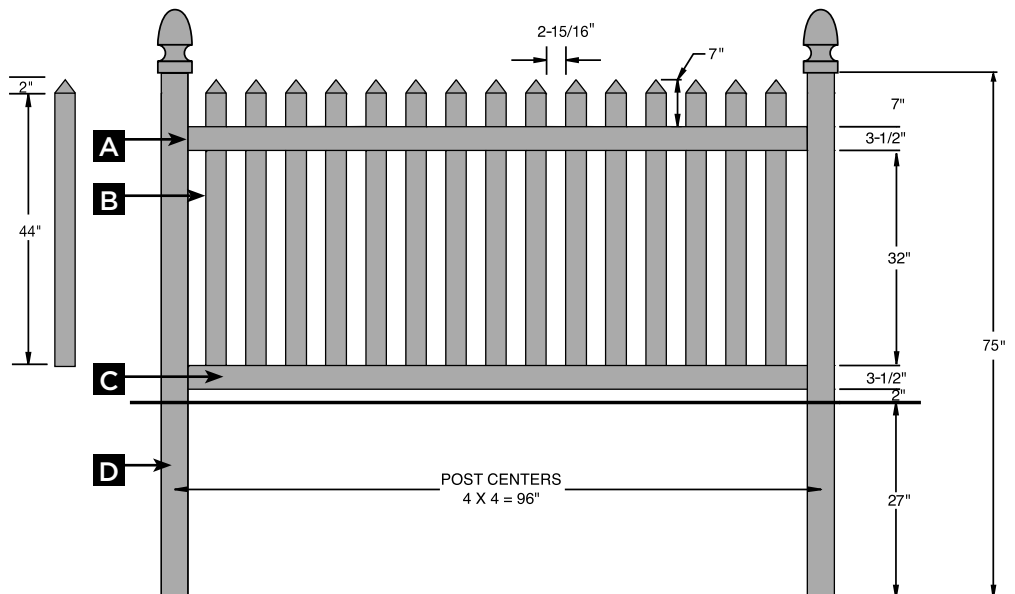

For colors, add color letters to item number: Almond (AL), Clay (C).

Note: Mixed color sections must be ordered as components; pricing will be higher than standard sections.

QUANTITY	PRODUCT NUMBER	DESCRIPTION
FENCE SECTIONS		
_____	20350	Danbury Concave Fence Section (4 to 3-1/2 ft. x 8 ft.)
<i>Note: Fence section includes A, B, C and section hardware. Post and caps sold separately.</i>		
4 IN. X 4 IN. POSTS		
_____	64321	T15 Concave Corner Post 4 in. x 4 in. x 75 in.
_____	64322	T15 Concave Line Post 4 in. x 4 in. x 75 in.
_____	64323	T15 Concave End Post 4 in. x 4 in. x 75 in.
_____	649075	Blank Post 4 in. x 4 in. x 75 in.
POST CAPS		
_____	70409	Gothic Cap Ext 4 in. x 4 in.
_____	70411	Flat Cap Int 4 in. x 4 in.
_____	70492	Ball Cap 4 in. x 4 in.
_____	70414	Flat Cap Ext 4 in. x 4 in.
_____	70426	New England Cap 4 in. x 4 in.
GATES (hardware ordered separately)		
_____	42708	T15 Concave Gate Kit (builds up to 50 in. wide gate)
_____	437020	Danbury Concave Preamsembled Gate 50 in. Wide
_____	70072	Aluminum 4 in. x 4 in. x 72 in. Gate Post Stiffener
_____	27635	Drop Pin Kit
_____	27741	3 ft. to 4 ft. Height Gate Hardware (self-closing hinges and latch)
_____	27744	Deluxe Key Entry Nylon Gate Hardware (3 ft. and 4 ft. height fence)
_____	27751	Plus Key Entry Nylon Gate Hardware (3 ft. and 4 ft. height fence)
_____	27731	Standard Stainless Steel Gate Hardware Pebble Black Finish
<i>Note: Gate kits include (2) 2-1/2 in. x 4 in. up-rights, caps and screws. Rails and pickets ordered separately.</i>		
OPTIONAL/EXTRA MATERIAL		
_____	28453	T15 2 in. x 4 in. x 95-1/2 in. Routed Mid Rail
_____	28454	T15 2 in. x 4 in. x 95-1/2 in. Routed Bottom Rail with Steel
_____	34604	Danbury Concave Fence Fill Kit 7/8 in. x 3 in. Picket (15 pc with pointed caps)
_____	4144000	Danbury Picket 7/8 in. x 3 in. x 44 in. with Pointed Cap, Crimped
_____	71413	1-5/8 in. EZ Set Post Brackets (pair with hardware - optional)

Note: 2" x 4" = 1-3/4" x 3-1/2"

A TOP RAIL

PALLET QUANTITY = 138
 2" x 4" x 95-1/2"

B PICKETS (with caps attached)

15 pickets of 7/8" x 3"
 PALLET QUANTITY = 30 Fill Kits
 Picket lengths:
 #1 = 44" #5 = 39-3/8"
 #2 = 42-3/4" #6 = 38-3/8"
 #3 = 41-1/2" #7 = 37-1/2"
 #4 = 40-3/8" #8 = 37"
 (pickets = 2 of each number except only 1 of number 8)
 Length does not include cap.

PICKET CAPS
 15 pieces of 7/8" x 3" x 2"
 Pointed picket caps.

C BOTTOM RAIL

PALLET QUANTITY = 138
 2" x 4" x 95-1/2"
 Includes steel channel.

D POST PALLET QUANTITY = 60
 4" x 4" x 75"

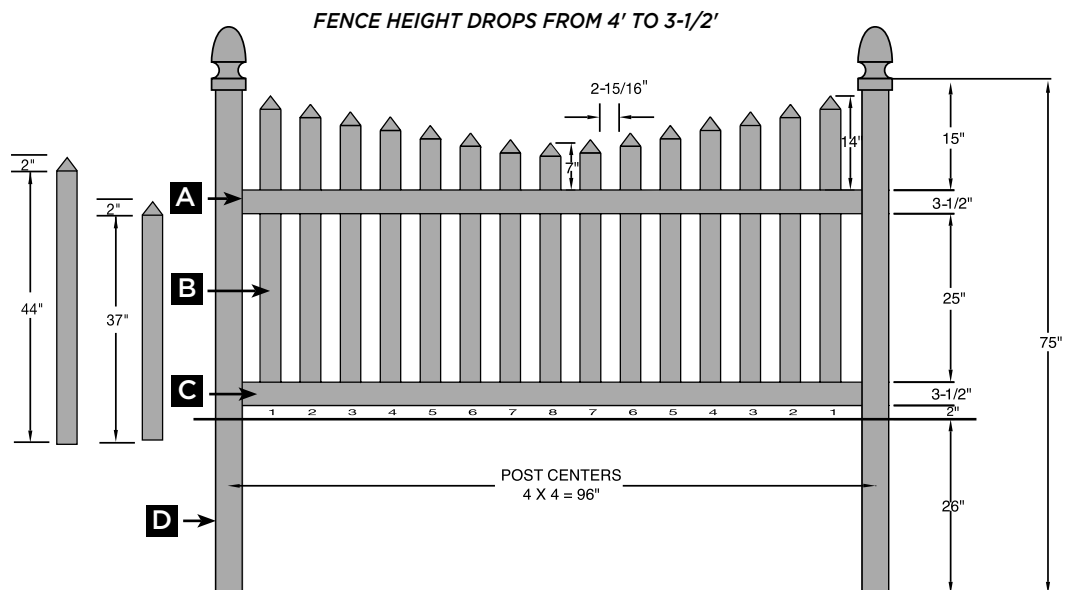

Racks up to 5 degrees

Traditional Danbury with Select Cedar Texture

4 ft. High / 8 ft. Wide

- Select one of the available colors**
- Almond ■ Arbor Blend ■ Arctic Blend
 - Clay ■ Sierra Blend
 - Weathered Blend ■ White

For colors, add color letters to item number: Almond (AL), Arbor Blend (AR4), Arctic Blend (AC4), Clay (C), Sierra Blend (SB4), Weathered Blend (WB4).

Note: Mixed color sections must be ordered as components; pricing will be higher than standard sections.

QUANTITY	PRODUCT NUMBER	DESCRIPTION
FENCE SECTIONS		
_____	30424	Danbury Select Cedar Texture Fence Section (4 ft. x 8 ft.)
<i>Note: Fence section includes A, B, C and section hardware. Post and caps sold separately.</i>		
5 IN. X 5 IN. POSTS		
_____	75731	T15 Textured Corner Post 5 in. x 5 in. x 75 in.
_____	75732	T15 Textured Line Post 5 in. x 5 in. x 75 in.
_____	75733	T15 Textured End Post 5 in. x 5 in. x 75 in.
_____	759075	CertaGrain Blank Post Heavy Wall 5 in. x 5 in. x 75 in.
POST CAPS		
_____	70444	CertaGrain Flat Top Cap Ext 5 in. x 5 in.
_____	70459	Textured New England Cap 5 in. x 5 in.
GATES (hardware ordered separately)		
_____	42745	T15 Textured Gate Kit (builds up to 50 in. wide gate)
_____	437081	Danbury Select Cedar Preassembled Gate 50 in. Wide
_____	70095	Aluminum 5 in. x 5 in. x 94 in. Gate Post Stiffener
_____	27635	Drop Pin Kit
_____	27742	5 ft. to 6 ft. Height Gate Hardware (self-closing hinges and latch)
_____	27745	Deluxe Key Entry Nylon Gate Hardware (5 ft. and 6 ft. height fence)
_____	27752	Plus Key Entry Nylon Gate Hardware (5 ft. and 6 ft. height fence)
_____	27747	LokkLatch Magnetic Gate Hardware (5 ft. and 6 ft. height fence)
_____	27731	Standard Stainless Steel Gate Hardware Pebble Black Finish
<i>Note: Gate kits include (2) 2-1/2 in. x 4 in. up-rights, caps and screws. Rails and pickets ordered separately.</i>		
OPTIONAL/EXTRA MATERIAL		
_____	906003	T15 Select Cedar 2 in. x 4 in. x 95-1/2 in. Routed Mid Rail
_____	906002	T15 Select Cedar 2 in. x 4 in. x 95-1/2 in. Routed Bottom Rail with Steel
_____	71414	2 in. EZ Set Post Brackets (pair with hardware - optional)
_____	92844	T15 Select Cedar Textured Picket 7/8 in. x 3 in. x 44 in. with Pointed Cap, Crimped

Note: 2" x 4" = 1-3/4" x 3-1/2"

- A TOP RAIL**
PALLET QUANTITY = 138
2" x 4" x 95-1/2"
- B PICKETS (with caps attached)**
15 pickets of 7/8" x 3" x 44"
PALLET QUANTITY = 450
Length does not include cap.
- PICKET CAPS**
15 pieces of 7/8" x 3" x 2"
Pointed picket caps.
- C BOTTOM RAIL**
PALLET QUANTITY = 138
2" x 4" x 95-1/2"
Includes steel channel.
- D POST** PALLET QUANTITY = 48
5" x 5" x 75"

Racks up to 5 degrees

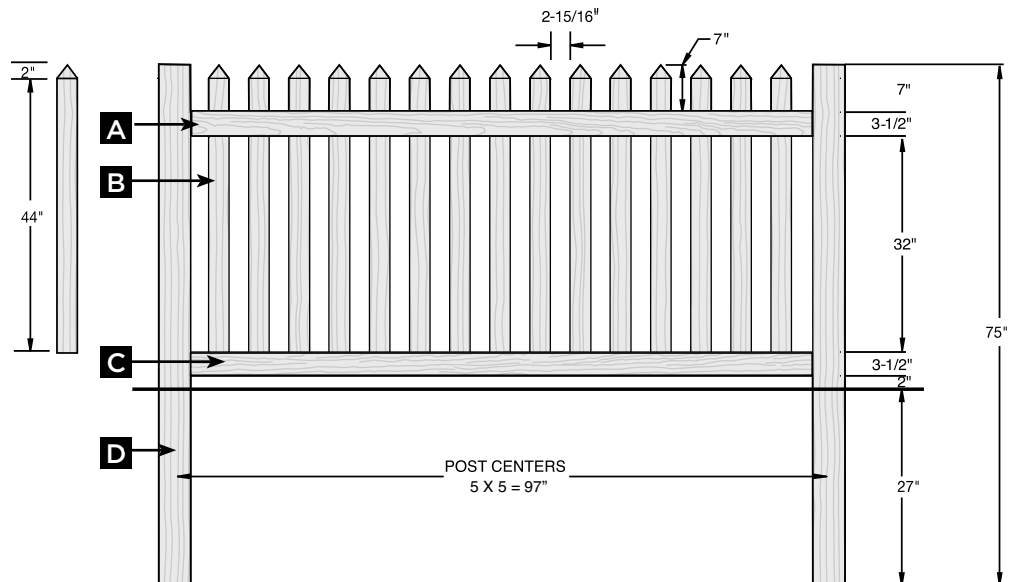

**Traditional
Danbury Concave with Select
Cedar Texture**

3.5-4 ft. High / 8 ft. Wide

Select one of the available colors
 ■ Almond ■ Arbor Blend ■ Arctic Blend
 ■ Clay ■ Sierra Blend
 ■ Weathered Blend ■ White

For colors, add color letters to item number: Almond (AL), Arbor Blend (AR4), Arctic Blend (AC4), Clay (C), Sierra Blend (SB4), Weathered Blend (WB4).

Note: Mixed color sections must be ordered as components; pricing will be higher than standard sections.

QUANTITY	PRODUCT NUMBER	DESCRIPTION
FENCE SECTIONS		
_____	30434	Danbury Select Cedar Texture Fence Section (4 to 3-1/2 ft. x 8 ft.)
<i>Note: Fence section includes A, B, C and section hardware. Post and caps sold separately.</i>		
5 IN. X 5 IN. POSTS		
_____	75771	T15 Textured Concave Corner Post 5 in. x 5 in. x 75 in.
_____	75772	T15 Textured Concave Line Post 5 in. x 5 in. x 75 in.
_____	75773	T15 Textured Concave End Post 5 in. x 5 in. x 75 in.
_____	759075	CertaGrain Blank Post Heavy Wall 5 in. x 5 in. x 75 in.
POST CAPS		
_____	70444	CertaGrain Flat Top Cap Ext 5 in. x 5 in.
_____	70459	Textured New England Cap 5 in. x 5 in.
GATES (hardware ordered separately)		
_____	42746	T15 Textured Concave Gate Kit (builds up to 50 in. wide gate)
_____	437082	Danbury Select Cedar Concave Preassembled Gate 50 in. Wide
_____	70095	Aluminum 5 in. x 5 in. x 94 in. Gate Post Stiffener
_____	27635	Drop Pin Kit
_____	27742	5 ft. to 6 ft. Height Gate Hardware (self-closing hinges and latch)
_____	27745	Deluxe Key Entry Nylon Gate Hardware (5 ft. and 6 ft. height fence)
_____	27752	Plus Key Entry Nylon Gate Hardware (5 ft. and 6 ft. height fence)
_____	27747	LokkLatch Magnetic Gate Hardware (5 ft. and 6 ft. height fence)
_____	27731	Standard Stainless Steel Gate Hardware Pebble Black Finish
<i>Note: Gate kits include (2) 2-1/2 in. x 4 in. up-rights, caps and screws. Rails and pickets ordered separately.</i>		
OPTIONAL/EXTRA MATERIAL		
_____	906003	T15 Select Cedar 2 in. x 4 in. x 95-1/2 in. Routed Mid Rail
_____	906002	T15 Select Cedar 2 in. x 4 in. x 95-1/2 in. Routed Bottom Rail with Steel
_____	92844	T15 Select Cedar Textured Picket 7/8 in. x 3 in. x 44 in. with Pointed Cap, Crimped
_____	71414	2 in. EZ Set Post Brackets (pair with hardware - optional)
_____	92604	T15 Select Cedar Fence Fill Kit 7/8 in. x 3 in. Picket (15 pc with pointed caps)

Note: 2" x 4" = 1-3/4" x 3-1/2"

- A TOP RAIL**
 PALLET QUANTITY = 138
 2" x 4" x 95-1/2"
- B PICKETS (with caps attached)**
 15 pickets of 7/8" x 3"
 PALLET QUANTITY = 30 Fill Kits
 Picket lengths:
 #1 = 44" #5 = 39-3/8"
 #2 = 42-3/4" #6 = 38-3/8"
 #3 = 41-1/2" #7 = 37-1/2"
 #4 = 40-3/8" #8 = 37"
 (pickets = 2 of each number except only 1 of number 8)
 Length does not include cap.
- C BOTTOM RAIL**
 PALLET QUANTITY = 138
 2" x 4" x 95-1/2"
 Includes steel channel.
- D POST** PALLET QUANTITY = 48
 5" x 5" x 75"

FENCE HEIGHT DROPS FROM 4' TO 3-1/2'

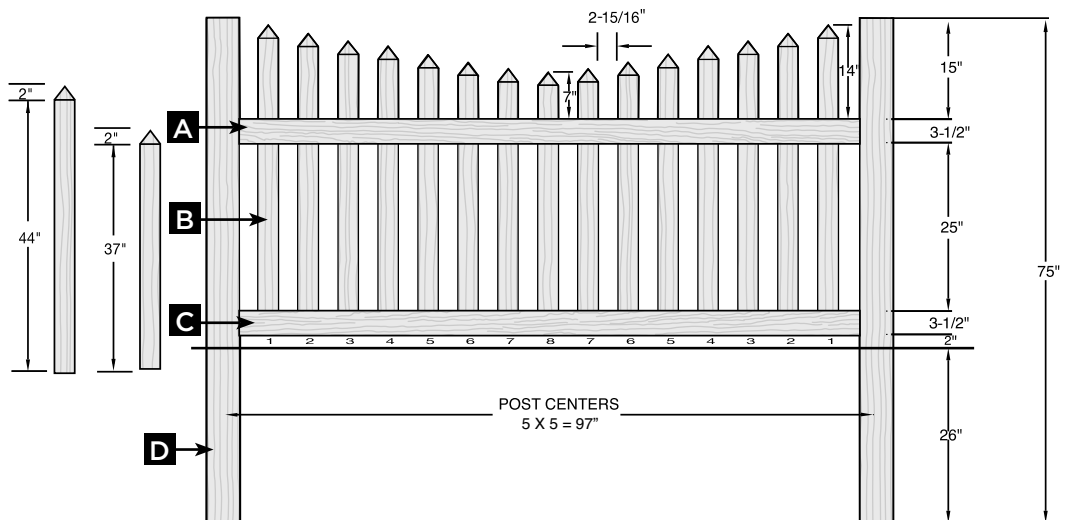

Racks up to 5 degrees

For Almond, add (AL) to item number.

Note: Mixed color sections must be ordered as components; pricing will be higher than standard sections.

QUANTITY	PRODUCT NUMBER	DESCRIPTION
FENCE SECTIONS		
_____	20355	Rothbury Fence Section (4 ft. x 8 ft.)

Note: Fence section includes A, B, C and section hardware. Post and caps sold separately.

4 IN. X 4 IN. POSTS		
_____	64311	T15 Corner Post 4 in. x 4 in. x 75 in.
_____	64312	T15 Line Post 4 in. x 4 in. x 75 in.
_____	64313	T15 End Post 4 in. x 4 in. x 75 in.
_____	649075	Blank Post 4 in. x 4 in. x 75 in.

POST CAPS		
_____	70409	Gothic Cap Ext 4 in. x 4 in.
_____	70411	Flat Cap Int 4 in. x 4 in.
_____	70492	Ball Cap 4 in. x 4 in.
_____	70414	Flat Cap Ext 4 in. x 4 in.
_____	70426	New England Cap 4 in. x 4 in.

GATES (hardware ordered separately)		
_____	42707	T15 Gate Kit (builds up to 50 in. wide gate)
_____	437019	Rothbury Preassembled Gate 50 in. Wide
_____	70072	Aluminum 4 in. x 4 in. x 72 in. Gate Post Stiffener
_____	27635	Drop Pin Kit
_____	27741	3 ft. to 4 ft. Height Gate Hardware (self-closing hinges and latch)
_____	27744	Deluxe Key Entry Nylon Gate Hardware (3 ft. and 4 ft. height fence)
_____	27751	Plus Key Entry Nylon Gate Hardware (3 ft. and 4 ft. height fence)
_____	27731	Standard Stainless Steel Gate Hardware Pebble Black Finish

Note: Gate kits include (2) 2-1/2 in. x 4 in. up-rights, caps and screws. Rails and pickets ordered separately.

OPTIONAL/EXTRA MATERIAL		
_____	28453	T15 2 in. x 4 in. x 95-1/2 in. Routed Mid Rail
_____	28454	T15 2 in. x 4 in. x 95-1/2 in. Routed Bottom Rail with Steel
_____	4144001	Rothbury Picket 7/8 in. x 3 in. x 44 in. with Dog Ear Cap, Crimped
_____	71413	1-5/8 in. EZ Set Post Brackets (pair with hardware - optional)

Note: 2" x 4" = 1-3/4" x 3-1/2"

- A TOP RAIL**
 PALLET QUANTITY = 138
 2" x 4" x 95-1/2"
- B PICKETS (with caps attached)**
 15 pickets of 7/8" x 3" x 44"
 PALLET QUANTITY = 450
 Length does not include cap.
- PICKET CAPS**
 15 pieces of 7/8" x 3" x 1"
 Dog Ear Picket Caps.
- C BOTTOM RAIL**
 PALLET QUANTITY = 138
 2" x 4" x 95-1/2"
 Includes steel channel.
- D POST** PALLET QUANTITY = 60
 4" x 4" x 75"

Racks up to 5 degrees

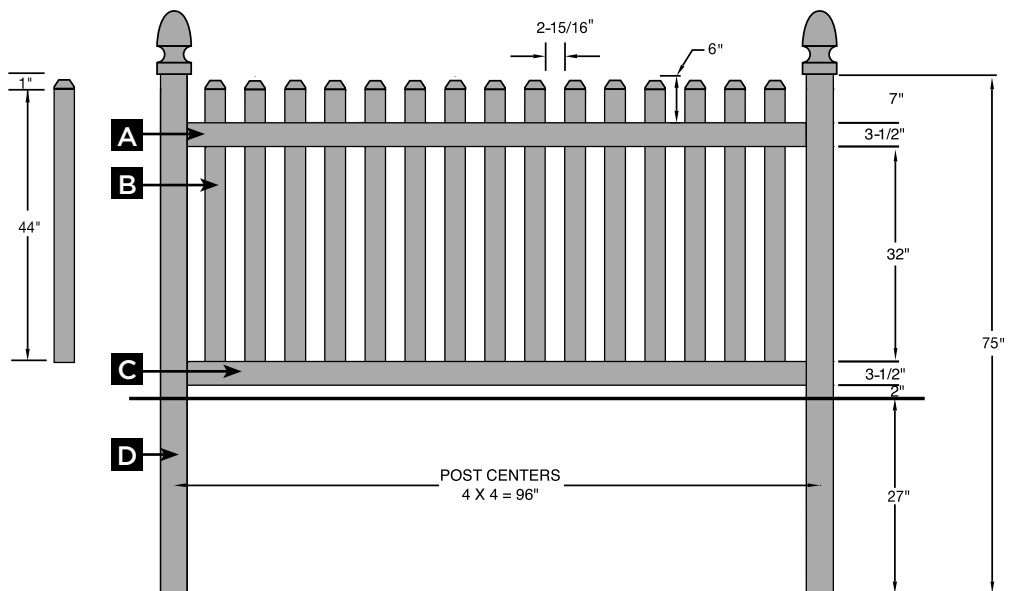

For Almond, add (AL) to item number.

Note: Mixed color sections must be ordered as components; pricing will be higher than standard sections.

QUANTITY	PRODUCT NUMBER	DESCRIPTION
FENCE SECTIONS		
_____	20356	Rothbury Concave Fence Section (4 ft. to 3-1/2 ft. x 8 ft.)
<i>Note: Fence section includes A, B, C and section hardware. Post and caps sold separately.</i>		
4 IN. X 4 IN. POSTS		
_____	64321	T15 Concave Corner Post 4 in. x 4 in. x 75 in.
_____	64322	T15 Concave Line Post 4 in. x 4 in. x 75 in.
_____	64323	T15 Concave End Post 4 in. x 4 in. x 75 in.
_____	649075	Blank Post 4 in. x 4 in. x 75 in.
POST CAPS		
_____	70409	Gothic Cap Ext 4 in. x 4 in.
_____	70411	Flat Cap Int 4 in. x 4 in.
_____	70492	Ball Cap 4 in. x 4 in.
_____	70414	Flat Cap Ext 4 in. x 4 in.
_____	70426	New England Cap 4 in. x 4 in.
GATES (hardware ordered separately)		
_____	42708	T15 Concave Gate Kit (builds up to 50 in. wide gate)
_____	437021	Rothbury Concave Preassembled Gate 50 in. Wide
_____	70072	Aluminum 4 in. x 4 in. x 72 in. Gate Post Stiffener
_____	27635	Drop Pin Kit
_____	27741	3 ft. to 4 ft. Height Gate Hardware (self-closing hinges and latch)
_____	27744	Deluxe Key Entry Nylon Gate Hardware (3 ft. and 4 ft. height fence)
_____	27751	Plus Key Entry Nylon Gate Hardware (3 ft. and 4 ft. height fence)
_____	27731	Standard Stainless Steel Gate Hardware Pebble Black Finish
<i>Note: Gate kits include (2) 2-1/2 in. x 4 in. up-rights, caps and screws. Rails and pickets ordered separately.</i>		
OPTIONAL/EXTRA MATERIAL		
_____	28453	T15 2 in. x 4 in. x 95-1/2 in. Routed Mid Rail
_____	28454	T15 2 in. x 4 in. x 95-1/2 in. Routed Bottom Rail with Steel
_____	34605	Rothbury Concave Fence Fill Kit 7/8 in. x 3 in. Picket (15 pc with dog ear caps)
_____	4144001	Rothbury Picket 7/8 in. x 3 in. x 44 in. with Dog Ear Cap, Crimped
_____	71413	1-5/8 in. EZ Set Post Brackets (pair with hardware - optional)

A TOP RAIL
 PALLET QUANTITY = 138
 2" x 4" x 95-1/2"

Note: 2" x 4" = 1-3/4" x 3-1/2"

B PICKETS (with caps attached)
 15 pickets of 7/8" x 3"
 PALLET QUANTITY = 30 Fill Kits
 Picket lengths:
 #1 = 44" #5 = 39-3/8"
 #2 = 42-3/4" #6 = 38-3/8"
 #3 = 41-1/2" #7 = 37-1/2"
 #4 = 40-3/8" #8 = 37"
 (pickets = 2 of each number except only 1 of number 8)
 Length does not include cap.

PICKET CAPS
 15 pieces of 7/8" x 3" x 1"
 Dog Ear Picket Caps.

C BOTTOM RAIL
 PALLET QUANTITY = 138
 2" x 4" x 95-1/2"
 Includes steel channel.

D POST
 PALLET QUANTITY = 60
 4" x 4" x 75"

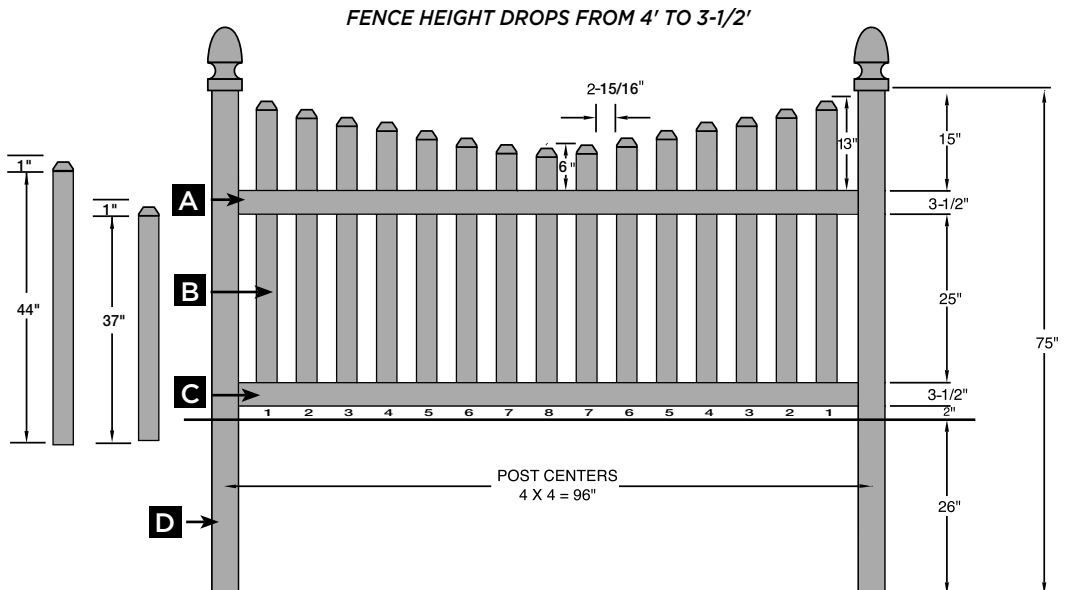

Racks up to 5 degrees

Gate Applications

Select one of the available colors

- Almond ■ Arbor Blend ■ Arctic Blend
- Brazilian Blend ■ Clay
- Frontier Blend ■ Grey ■ Sierra Blend
- Timber Blend ■ Weathered Blend
- White

For colors, add color letters to item number: Almond (AL), Arbor Blend (AR4), Arctic Blend (AC4), Brazilian Blend (BR4), Clay (C), Frontier Blend (FB4), Grey (G), Sierra Blend (SB4), Timber Blend (TB4), Weathered Blend (WB4)

QUANTITY	PRODUCT NUMBER	DESCRIPTION
_____	70072	Aluminum 4 in. x 4 in. x 72 in. Gate Post Stiffener
_____	70082	Aluminum 4 in. x 4 in. x 82 in. Gate Post Stiffener
_____	70095	Aluminum 5 in. x 5 in. x 94 in. Gate Post Stiffener
_____	70106	Aluminum 5 in. x 5 in. x 106 in. Gate Post Stiffener
_____	27635	Drop Pin Kit
_____	27630	MagnaLatch
_____	27741	3 ft. to 4 ft. Height Gate Hardware (self-closing hinges and latch)
_____	27742	5 ft. to 6 ft. Height Gate Hardware (self-closing hinges and latch)
_____	27744	Deluxe Key Entry Nylon Gate Hardware (3 ft. and 4 ft. height fence)
_____	27751	Plus Key Entry Nylon Gate Hardware (3 ft. and 4 ft. height fence)
_____	27745	Deluxe Key Entry Nylon Gate Hardware (5 ft. and 6 ft. height fence)
_____	27752	Plus Key Entry Nylon Gate Hardware (5 ft. and 6 ft. height fence)
_____	27747	LokkLatch Magnetic Gate Hardware (5 ft. and 6 ft. height fence)
_____	27731	Standard Stainless Steel Gate Hardware Pebble Black Finish
_____	71100P	Rebar Separator Clip (4 pair/bag)
_____	71106	Aluminum 5 in. x 5 in. x 106 in. Line Post Stiffener
_____	27637	Gate Wheel Black
_____	219074	2-1/2 in. x 4 in. x 74-1/2 in. Blank Gate Upright
_____	919074	2-1/2 in. x 4 in. x 74-1/2 in. Blank Gate Upright Select Cedar
_____	719074	2-1/2 in. x 4 in. x 74-1/2 in. Blank Gate Upright CertaGrain

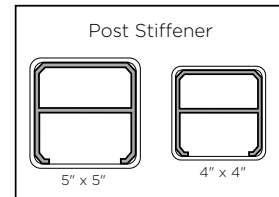

Aluminum gate post stiffeners can be used as a replacement for concrete and rebar at gate hinge/latch posts.



Gate wheel black.

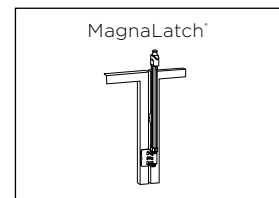

MagnaLatch[†] to be used for additional safety to meet swimming pool codes.



LokkLatch[†] magnetic.

	Pre-Assembled Gate Widths	Unassembled Gate Kit Maximum Width	Extension Kit Required**
Galveston	50-1/2"	50-1/2"	No
Brookline	50-1/2"	70"	Yes
Chesterfield[†]	36-1/2" 50-1/2" 64-3/4"	70"	Yes
Chesterfield Concave Accent	50-1/2"	na	na
Chesterfield Convex Accent	50-1/2"	na	na
New Lexington	42-1/2" 50-1/2" 65-1/4"	72"	Yes
Breezewood	50"	60"	Yes
Imperial	50"	72"	Yes
Millbrook / Columbia	50"	60"	Yes
Baron	50"	72"	Yes
Princeton	50"	72"	Yes
Countess	50"	72"	Yes
Victorian	50"	72"	Yes
Manchester	50"	50"	No
Manchester Concave	na	50"	No
Danbury	50"	50"	No
Cape Cod	50"	60"	Yes
Rothbury	50"	50"	No
2-Rail*	na	72"	na
3-Rail*	na	96"	na
4-Rail*	na	96"	na
Crossback*	na	96"	na

[†] Not all widths available in all heights.

* All gates are rackable, except Post & Rail (2-Rail, 3-Rail and 4-Rail smooth finish), and Crossback styles.

** For unassembled gate kits over 50" wide to achieve maximum width

**Post & Rail
2 Rail Fence**

**1-1/2 in. X 5-1/2 in. Small
Rail**

Select one of the available colors
 Almond White

For Almond, add (AL) to item number.

QUANTITY	PRODUCT NUMBER	DESCRIPTION
RAILS 1-1/2 IN. X 5-1/2 IN. SMALL RAIL		
_____	569096	Ribbed Rail 1-1/2 in. x 5-1/2 in. x 96 in.
_____	569192	1-1/2 in. x 5-1/2 in. x 192 in. Rail Ribbed (minimum order: 25 pc)
POSTS		
_____	53121	Small Rail Corner Post 5 in. x 5 in. x 68 in. (2 rail)
_____	53122	Small Rail Line Post 5 in. x 5 in. x 68 in. (2 rail)
_____	53123	Small Rail End Post 5 in. x 5 in. x 68 in. (2 rail)
_____	539068	Blank Post 5 in. x 5 in. x 68 in.
CAPS		
_____	70416	Gothic Cap Ext 5 in. x 5 in.
_____	70417	Flat Cap Int 5 in. x 5 in.
_____	70418	Flat Cap Ext 5 in. x 5 in.
_____	70427	New England Cap Ext 5 in. x 5 in.
_____	60783P	Lock Rings (order 2 per rail) Qty: 24
GATES 1-1/2 IN. X 5-1/2 IN. SMALL RAIL GATES (GATES DO NOT INCLUDE RAILS)		
_____	62114	Small Rail Style Gate Kit (2 rail) will allow up to 6 ft. gate (hardware included)
_____	27636	Double Drive Drop Pin Kit
_____	70095	Aluminum 5 in. x 5 in. x 94 in. Gate Post Stiffener

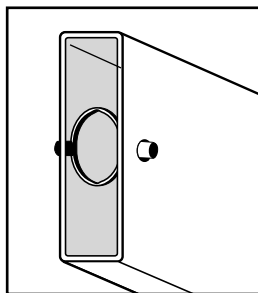
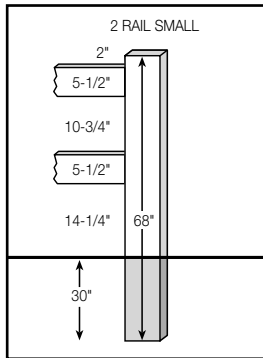

THE
LOCK
RING
SECURES
THE RAIL
INSIDE
THE
POST.

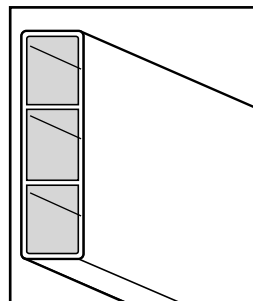

2 RAIL AVAILABLE IN
1-1/2" x 5-1/2" RIBBED.

For Almond, add (AL) to item number.

QUANTITY	PRODUCT NUMBER	DESCRIPTION
RAILS 1-1/2 IN. X 5-1/2 IN. SMALL RAIL		
_____	569096	Ribbed Rail 1-1/2 in. x 5-1/2 in. x 96 in.
_____	569192	1-1/2 in. x 5-1/2 in. x 192 in. Rail Ribbed (minimum order: 25 pc)
POSTS - SMALL RAIL		
_____	53331	Small Rail Corner Post 5 in. x 5 in. x 84 in. (3 rail)
_____	53332	Small Rail Line Post 5 in. x 5 in. x 84 in. (3 rail)
_____	53333	Small Rail End Post 5 in. x 5 in. x 84 in. (3 rail)
_____	53811	Small Rail Corner Post 5 in. x 5 in. x 78 in. (3 rail)
_____	53812	Small Rail Line Post 5 in. x 5 in. x 78 in. (3 rail)
_____	53813	Small Rail End Post 5 in. x 5 in. x 78 in. (3 Rail)
_____	539078	Blank Post 5 in. x 5 in. x 78 in.
GATES 1-1/2 IN. X 5-1/2 IN. SMALL RAIL GATES (GATES DO NOT INCLUDE RAILS)		
_____	62316	Small Rail Style Gate Kit (3 rail) will allow up to 8 ft. gate (hardware included)
RAILS 2 IN. X 6 IN. LARGE RAIL		
_____	589096	2 in. x 6 in. x 96 in. Ribbed
_____	589192	2 in. x 6 in. x 192 in. Ribbed (minimum order: 25 pc)
POSTS - LARGE RAIL		
_____	53431	Large Rail Corner Post 5 in. x 5 in. x 84 in. (3 rail)
_____	53432	Large Rail Line Post 5 in. x 5 in. x 84 in. (3 rail)
_____	53433	Large Rail End Post 5 in. x 5 in. x 84 in. (3 rail)
GATES 2 IN. X 6 IN. LARGE RAIL GATES (GATES DO NOT INCLUDE RAILS)		
_____	62416	Large Rail Style (3 rail) will allow up to 8 ft. gate (hardware included)
CAPS		
_____	70416	Gothic Cap Ext 5 in. x 5 in.
_____	70417	Flat Cap Int 5 in. x 5 in.
_____	70418	Flat Cap Ext 5 in. x 5 in.
_____	70427	New England Cap Ext 5 in. x 5 in.
BLANK POST		
_____	539084	Blank Post 5 in. x 5 in. x 84 in.
HARDWARE		
_____	60783P	Lock Rings (order 2 per rail) Qty: 24
_____	27636	Double Drive Drop Pin Kit
_____	70095	Aluminum 5 in. x 5 in. x 94 in. Gate Post Stiffener

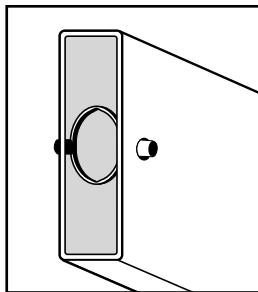
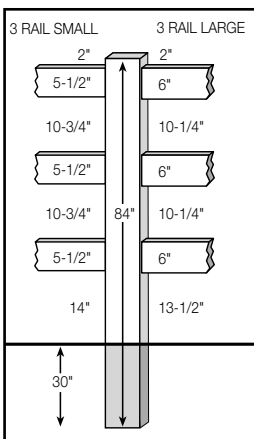

THE LOCK RING SECURES THE RAIL INSIDE THE POST.

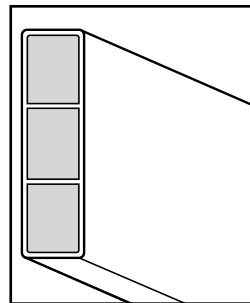

SELECTION OF 1-1/2" x 5-1/2" OR 2" x 6" RAILS.

For Almond, add (AL) to item number.

QUANTITY	PRODUCT NUMBER	DESCRIPTION
RAILS 1-1/2 IN. X 5-1/2 IN. SMALL RAIL		
_____	569096	Ribbed Rail 1-1/2 in. x 5-1/2 in. x 96 in.
_____	569192	1-1/2 in. x 5-1/2 in. x 192 in. Rail Ribbed (minimum order: 25 pc)
POSTS - SMALL RAIL		
_____	53741	Small Rail Corner Post 5 in. x 5 in. x 96 in. (4 rail)
_____	53742	Small Rail Line Post 5 in. x 5 in. x 96 in. (4 rail)
_____	53743	Small Rail End Post 5 in. x 5 in. x 96 in. (4 rail)
GATES 1-1/2 IN. X 5-1/2 IN. SMALL RAIL GATES (GATES DO NOT INCLUDE RAILS)		
_____	62516	Small Rail Style Gate Kit (4 rail) will allow up to 8 ft. gate (hardware included)
RAILS 2 IN. X 6 IN. LARGE RAIL		
_____	589096	2 in. x 6 in. x 96 in. Ribbed
_____	589192	2 in. x 6 in. x 192 in. Ribbed (minimum order: 25 pc)
POSTS - LARGE RAIL		
_____	53641	Large Rail Corner Post 5 in. x 5 in. x 96 in. (4 rail)
_____	53642	Large Rail Line Post 5 in. x 5 in. x 96 in. (4 rail)
_____	53643	Large Rail End Post 5 in. x 5 in. x 96 in. (4 rail)
GATES 2 IN. X 6 IN. LARGE RAIL GATES (GATES DO NOT INCLUDE RAILS)		
_____	62616	Large Rail Style Gate Kit (4 rail) will allow up to 8 ft. gate (hardware included)
CAPS		
_____	70416	Gothic Cap Ext 5 in. x 5 in.
_____	70417	Flat Cap Int 5 in. x 5 in.
_____	70418	Flat Cap Ext 5 in. x 5 in.
_____	70427	New England Cap Ext 5 in. x 5 in.
BLANK POST		
_____	539096	Blank Post 5 in. x 5 in. x 96 in.
HARDWARE		
_____	60783P	Lock Rings (order 2 per rail) Qty: 24
_____	27636	Double Drive Drop Pin Kit
_____	70095	Aluminum 5 in. x 5 in. x 94 in. Gate Post Stiffener

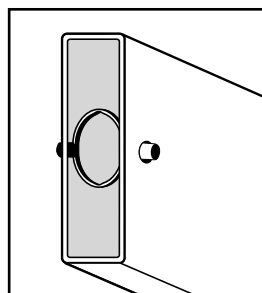
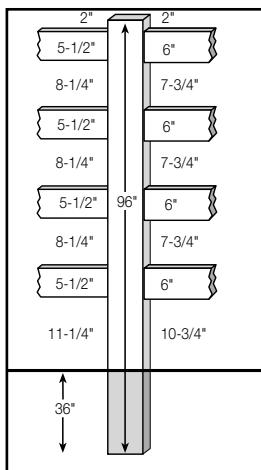

THE LOCK RING SECURES THE RAIL INSIDE THE POST.

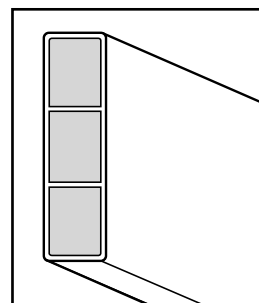

SELECTION OF 1-1/2" x 5-1/2" OR 2" x 6" RAILS.

Post & Rail Crossback

Select one of the available colors
 White

QUANTITY	PRODUCT NUMBER	DESCRIPTION
FENCE SECTIONS		
_____	569096	Ribbed Rail 1-1/2 in. x 5-1/2 in. x 96 in.
_____	569192	1-1/2 in. x 5-1/2 in. x 192 in. Rail Ribbed (minimum order: 25 pc)
_____	569097	1-1/2 in. x 5-1/2 in. x 97 in. Ribbed Cross Rail
POSTS		
_____	53841	Crossback Corner Post 5 in. x 5 in. x 84 in.
_____	53842	Crossback Line Post 5 in. x 5 in. x 84 in.
_____	53843	Crossback End Post 5 in. x 5 in. x 84 in.
_____	539084	Blank Post 5 in. x 5 in. x 84 in.
CAPS		
_____	70416	Gothic Cap Ext 5 in. x 5 in.
_____	70417	Flat Cap Int 5 in. x 5 in.
_____	70418	Flat Cap Ext 5 in. x 5 in.
_____	70427	New England Cap Ext 5 in. x 5 in.
_____	60783P	Lock Rings (order 2 per rail) Qty: 24
GATES (GATES DO NOT INCLUDE RAILS)		
_____	62826	Crossback Gate 8 ft. Wide (includes hardware)
_____	27636	Double Drive Drop Pin Kit
_____	70095	Aluminum 5 in. x 5 in. x 94 in. Gate Post Stiffener

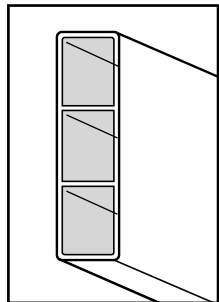

CROSSBACK IS SUPPLIED WITH 1-1/2" x 5-1/2" RIBBED RAILS.

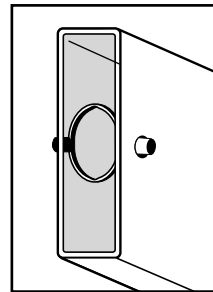

THE LOCK RING SECURES THE RAIL INSIDE THE POST.

- A TOP RAIL**
1-1/2" x 5-1/2" x 96" or 1-1/2" x 5-1/2" x 192"
Ribbed rail.
- B DIAGONAL RAILS**
1-1/2" x 5-1/2" x 97"
Ribbed rail.
- C BOTTOM RAIL**
1-1/2" x 5-1/2" x 96" or 1-1/2" x 5-1/2" x 192"
Ribbed rail.
- D POST**
5" x 5" x 84"

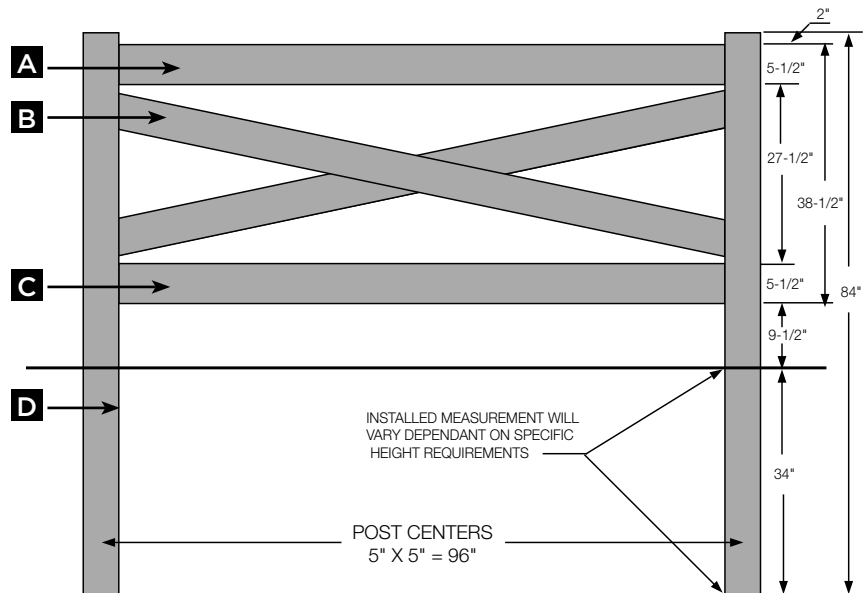

**Post & Rail
2 Rail Fence with CertaGrain
Texture**

2 in. X 6 in. Large Rail

Select one of the available colors
 ■ Arctic Blend ■ Brazilian Blend
 ■ Sierra Blend ■ Weathered Blend

For colors, add color letters to item number: Arctic Blend (AC4), Brazilian Blend (BR4), Sierra Blend (SB4), Weathered Blend (WB4).

QUANTITY	PRODUCT NUMBER	DESCRIPTION
RAILS 2 IN. X 6 IN. LARGE RAIL		
_____	809072	CertaGrain 2 in. x 6 in. x 72 in. Rail Ribbed
_____	809144	CertaGrain 2 in. x 6 in. x 144 in. Rail Ribbed
POSTS		
_____	74121	2 Rail Large CertaGrain Corner Post 5 in. x 5 in. x 68 in.
_____	74122	2 Rail Large CertaGrain Line Post 5 in. x 5 in. x 68 in.
_____	74123	2 Rail Large CertaGrain End Post 5 in. x 5 in. 68 in.
_____	759068	CertaGrain Blank Post Heavy Wall 5 in. x 5 in. x 68 in.
CAPS		
_____	60783P	Lock Rings (order 2 per rail) Qty: 24
_____	70459	Textured New England Cap 5 in. x 5 in.
_____	70444	CertaGrain Flat Top Cap Ext 5 in. x 5 in.
GATES RAILS 2 IN. 6 IN. LARGE RAIL GATES (GATES DO NOT INCLUDE RAILS)		
_____	70095	Aluminum 5 in. x 5 in. x 94 in. Gate Post Stiffener
_____	72226	CertaGrain 2 Rail Style (builds up to 6 ft. gate) hardware included
_____	27636	Double Drive Drop Pin Kit

Note: Post centers for CertaGrain Post and Rail fence in Arctic Blend, Brazilian Blend, Sierra Blend and Weathered Blend are 6' on center.

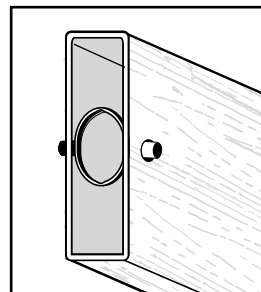
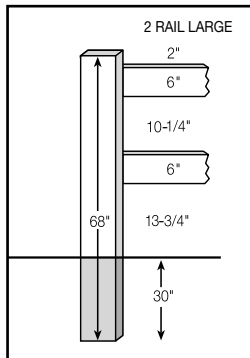

THE LOCK RING SECURES THE RAIL INSIDE THE POST.

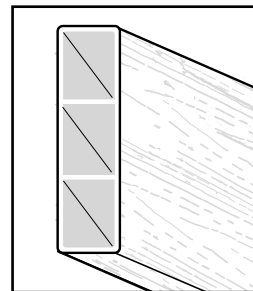

2" x 6" RIBBED ONLY.

**Post & Rail
3 Rail Fence with CertaGrain
Texture**

2 in. X 6 in. Large Rail

Select one of the available colors
 ■ Arctic Blend ■ Brazilian Blend
 ■ Sierra Blend ■ Weathered Blend

For colors, add color letters to item number: Arctic Blend (AC4), Brazilian Blend (BR4), Sierra Blend (SB4), Weathered Blend (WB4).

QUANTITY	PRODUCT NUMBER	DESCRIPTION
RAILS 2 IN. X 6 IN. LARGE RAIL		
_____	809072	CertaGrain 2 in. x 6 in. x 72 in. Rail Ribbed
_____	809144	CertaGrain 2 in. x 6 in. x 144 in. Rail Ribbed
POSTS		
_____	74131	3 Rail Large CertaGrain Corner Post 5 in. x 5 in. x 84 in.
_____	74132	3 Rail Large CertaGrain Line Post 5 in. x 5 in. x 84 in.
_____	74133	3 Rail Large CertaGrain End Post 5 in. x 5 in. x 84 in.
_____	759084	CertaGrain Blank Post 5 in. x 5 in. x 84 in.
CAPS		
_____	70444	CertaGrain Flat Top Cap Ext 5 in. x 5 in.
_____	70459	Textured New England Cap 5 in. x 5 in.
_____	60783P	Lock Rings (order 2 per rail) Qty: 24
GATES RAILS 2 IN. X 6 IN. LARGE RAIL (GATES DO NOT INCLUDE RAILS)		
_____	70095	Aluminum 5 in. x 5 in. x 94 in. Gate Post Stiffener
_____	72238	CertaGrain 3 Rail Style (builds up to 8 ft. gate) hardware included
_____	809095	2 in. x 6 in. x 95 in. Rail
_____	27636	Double Drive Drop Pin Kit

Note: Post centers for CertaGrain Post and Rail fence in Arctic Blend, Brazilian Blend, Sierra Blend and Weathered Blend are 6' on center.

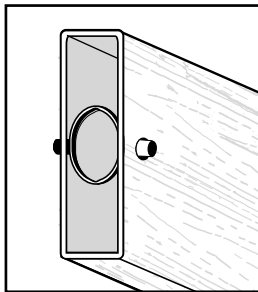
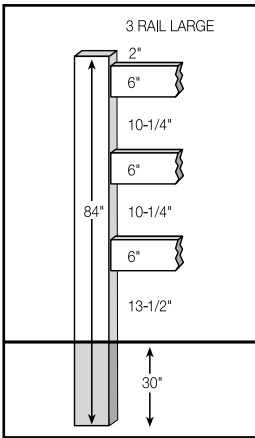

THE LOCK RING SECURES THE RAIL INSIDE THE POST.

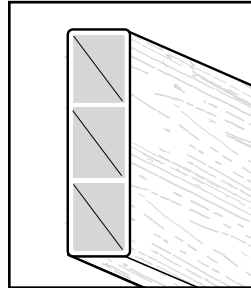

2" x 6" RIBBED ONLY.

**Post & Rail
4 Rail Fence with CertaGrain
Texture**

2 in. X 6 in. Large Rail

Select one of the available colors
 ■ Arctic Blend ■ Brazilian Blend
 ■ Sierra Blend ■ Weathered Blend

For colors, add color letters to item number: Arctic Blend (AC4), Brazilian Blend (BR4), Sierra Blend (SB4), Weathered Blend (WB4).

QUANTITY	PRODUCT NUMBER	DESCRIPTION
RAILS 2 IN. X 6 IN. LARGE RAIL		
_____	809072	CertaGrain 2 in. x 6 in. x 72 in. Rail Ribbed
_____	809144	CertaGrain 2 in. x 6 in. x 144 in. Rail Ribbed
POSTS		
_____	74141	4 Rail Large CertaGrain Corner Post 5 in. x 5 in. x 96 in.
_____	74142	4 Rail Large CertaGrain Line Post 5 in. x 5 in. x 96 in.
_____	74143	4 Rail Large CertaGrain End Post 5 in. x 5 in. x 96 in.
_____	759096	CertaGrain Blank Post Heavy Wall 5 in. x 5 in. x 96 in.
CAPS		
_____	70459	Textured New England Cap 5 in. x 5 in.
_____	70444	CertaGrain Flat Top Cap Ext 5 in. x 5 in.
_____	60783P	Lock Rings (order 2 per rail) Qty: 24
GATES RAILS 2 IN. X 6 IN. LARGE RAIL (GATES DO NOT INCLUDE RAILS)		
_____	70095	Aluminum 5 in. x 5 in. x 94 in. Gate Post Stiffener
_____	72248	CertaGrain 4 Rail Style (builds up to 8 ft. gate) hardware included
_____	809095	2 in. x 6 in. x 95 in. Rail
_____	27636	Double Drive Drop Pin Kit

Note: Post centers for CertaGrain Post and Rail fence in Arctic Blend, Brazilian Blend, Sierra Blend and Weathered Blend are 6' on center.

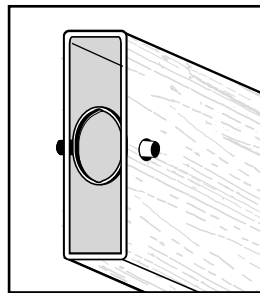
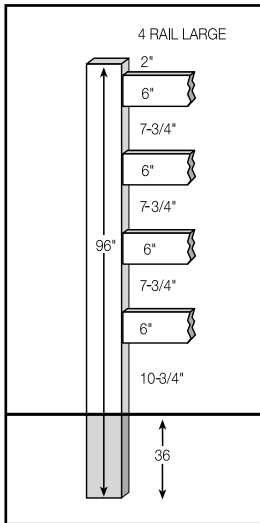

THE LOCK RING SECURES THE RAIL INSIDE THE POST.

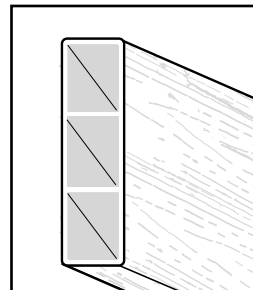

2" x 6" RIBBED ONLY.

**Post & Rail
2 Rail Fence with CertaGrain
Texture**

1-1/2 in. X 5-1/2 in. Small Rail

Select one of the available colors
 White

QUANTITY	PRODUCT NUMBER	DESCRIPTION
RAILS 1-1/2 IN. X 5-1/2 IN. SMALL RAIL		
_____	779096	CertaGrain Ribbed Rail 1-1/2 in. x 5-1/2 in. x 96 in.
_____	779192	CertaGrain Ribbed Rail 1-1/2 in. x 5-1/2 in. x 192 in. (minimum order: 25 pc)
POSTS		
_____	72121	2 Rail Small CertaGrain Corner Post 5 in. x 5 in. x 68 in.
_____	72122	2 Rail Small CertaGrain Line Post 5 in. x 5 in. x 68 in.
_____	72123	2 Rail Small CertaGrain End Post 5 in. x 5 in. x 68 in.
_____	759068	CertaGrain Blank Post Heavy Wall 5 in. x 5 in. x 68 in.
CAPS		
_____	70459	Textured New England Cap 5 in. x 5 in.
_____	70444	CertaGrain Flat Top Cap Ext 5 in. x 5 in.
_____	60783P	Lock Rings (order 2 per rail) Qty: 24
GATES 1-1/2 IN. X 5-1/2 IN. SMALL RAIL GATES (GATES DO NOT INCLUDE RAILS)		
_____	70095	Aluminum 5 in. x 5 in. x 94 in. Gate Post Stiffener
_____	72126	CertaGrain 2 Rail Style (builds up to 6 ft. gate) hardware included
_____	27636	Double Drive Drop Pin Kit

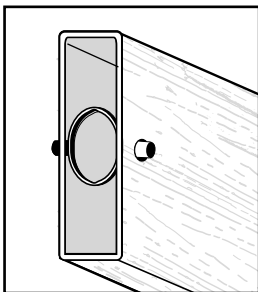
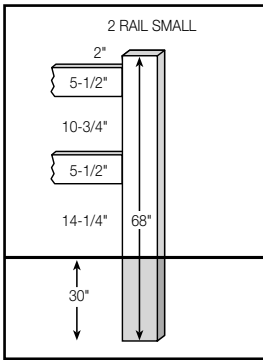

THE LOCK RING SECURES THE RAIL INSIDE THE POST.

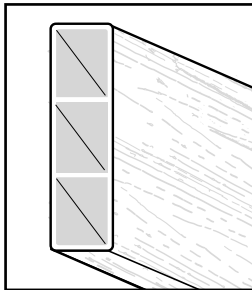

1-1/2" x 5-1/2" RIBBED ONLY.

**Post & Rail
3 Rail Fence with CertaGrain
Texture**

1-1/2 in. X 5-1/2 in. Small Rail

Select one of the available colors
 White

QUANTITY	PRODUCT NUMBER	DESCRIPTION
RAILS 1-1/2 IN. X 5-1/2 IN. SMALL RAIL		
_____	779096	CertaGrain Ribbed Rail 1-1/2 in. x 5-1/2 in. x 96 in.
_____	779192	CertaGrain Ribbed Rail 1-1/2 in. x 5-1/2 in. x 192 in. (minimum order: 25 pc)
POSTS		
_____	72131	3 Rail Small CertaGrain Corner Post 5 in. x 5 in. x 84 in.
_____	72132	3 Rail Small CertaGrain Line Post 5 in. x 5 in. x 84 in.
_____	72133	3 Rail Small CertaGrain End Post 5 in. x 5 in. x 84 in.
_____	759084	CertaGrain Blank Post 5 in. x 5 in. x 84 in.
CAPS		
_____	70459	Textured New England Cap 5 in. x 5 in.
_____	70444	CertaGrain Flat Top Cap Ext 5 in. x 5 in.
_____	60783P	Lock Rings (order 2 per rail) Qty: 24
GATES 1-1/2 IN. X 5-1/2 IN. SMALL RAIL GATES (GATES DO NOT INCLUDE RAILS)		
_____	70095	Aluminum 5 in. x 5 in. x 94 in. Gate Post Stiffener
_____	72138	CertaGrain 3 Rail Style (builds up to 8 ft. gate) hardware included
_____	27636	Double Drive Drop Pin Kit

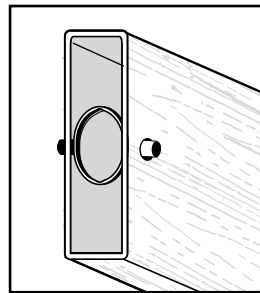
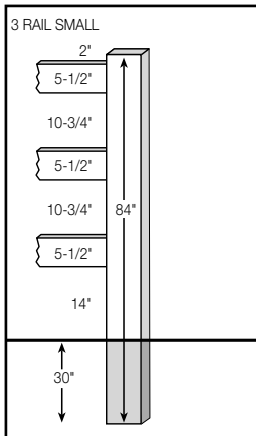

THE LOCK RING SECURES THE RAIL INSIDE THE POST.

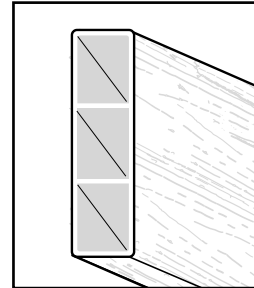

1-1/2" x 5-1/2" RIBBED ONLY.

**Post & Rail
4 Rail Fence with CertaGrain
Texture**

1-1/2 in. X 5-1/2 in. Small Rail

Select one of the available colors
 White

QUANTITY	PRODUCT NUMBER	DESCRIPTION
RAILS 1-1/2 IN. X 5-1/2 IN. SMALL RAIL		
_____	779096	CertaGrain Ribbed Rail 1-1/2 in. x 5-1/2 in. x 96 in.
_____	779192	CertaGrain Ribbed Rail 1-1/2 in. x 5-1/2 in. x 192 in. (minimum order: 25 pc)
POSTS		
_____	72141	4 Rail Small CertaGrain Corner Post 5 in. x 5 in. x 96 in.
_____	72142	4 Rail Small CertaGrain Line Post 5 in. x 5 in. x 96 in.
_____	72143	4 Rail Small CertaGrain End Post 5 in. x 5 in. x 96 in.
_____	759096	CertaGrain Blank Post Heavy Wall 5 in. x 5 in. x 96 in.
CAPS		
_____	70459	Textured New England Cap 5 in. x 5 in.
_____	70444	CertaGrain Flat Top Cap Ext 5 in. x 5 in.
_____	60783P	Lock Rings (order 2 per rail) Qty: 24
GATES 1-1/2 IN. X 5-1/2 IN. SMALL RAIL GATES (GATES DO NOT INCLUDE RAILS)		
_____	70095	Aluminum 5 in. x 5 in. x 94 in. Gate Post Stiffener
_____	72148	CertaGrain 4 Rail Style (builds up to 8 ft. gate) hardware included
_____	27636	Double Drive Drop Pin Kit

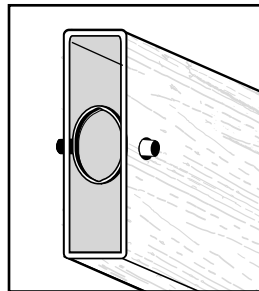
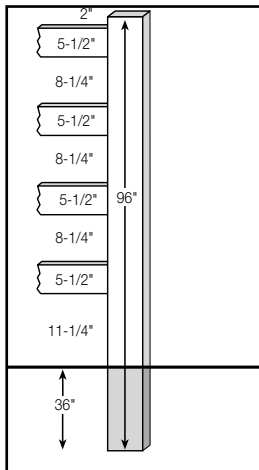

THE LOCK RING SECURES THE RAIL INSIDE THE POST.

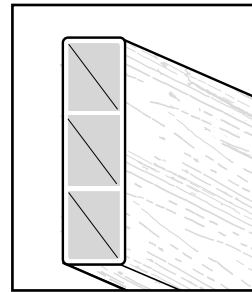

1-1/2" x 5-1/2" RIBBED

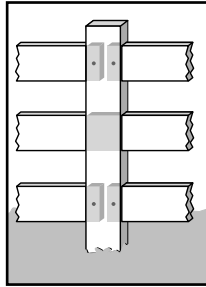

RAIL ENDS ARE ALTERNATED BETWEEN POSTS TO INCREASE STRENGTH AND DURABILITY.
 8' RAILS ARE AVAILABLE FOR GATES AND SHORT SECTIONS.
 LOCK RING SECURES RAIL INSIDE POST.

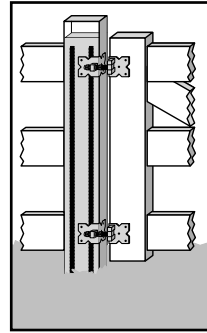

GATE POSTS AND END POSTS ARE FILLED WITH CONCRETE AND REBAR TO ENSURE STABILITY OF THE GATE. ALL POSTS ARE NORMALLY SET IN CONCRETE.

For current full truckload pricing of Post & Rail products, contact your Bufftech Sales Representative.

TRUCKLOAD CALCULATION*		
TRUCKLOAD CALCULATIONS FIGURED IN LINEAL FEET AND ARE BASED ON 8' POST CENTERS		
	1-1/2" x 5-1/2" RAILS	2" x 6" RAILS
2 RAIL	9152'	—
3 RAIL	6656'	4928'
4 RAIL	5408'	4032'

*APPROXIMATE AMOUNT OF MATERIAL PER TRUCKLOAD INCLUDING RAILS, POSTS, GATES, CAPS, AND OTHER MISCELLANEOUS MATERIAL.

For colors, add color letters to item number: Almond (AL), Clay (C).

QUANTITY	PRODUCT NUMBER	DESCRIPTION
POSTS - BLANK: 4 IN. X 4 IN. POSTS		
_____	649038	Blank Post 4 x 4 x 38
_____	649044	Blank Post 4 in x 4 in. x 44 in.
_____	649048	Blank Post 4 in. x 4 in. x 48 in.
_____	649051	Blank Post 4 in. x 4 in. x 51-1/2 in.
_____	649064	Blank Post 4 in. x 4 in. x 64 in.
_____	649075	Blank Post 4 in. x 4 in. x 75 in.
_____	649084	Blank Post 4 in. x 4 in. x 84 in.
_____	649090	Blank Post 4 in. x 4 in. x 90 in.
_____	649144	Blank Post 4 in. x 4 in. x 144 in. (min.quantity 60)
POSTS - BLANK: REGULAR WALL 5 IN, X 5 IN. POSTS		
_____	539068	Blank Post 5 in. x 5 in. x 68 in.
_____	539072	Blank Post 5 in. x 5 in. x 72 in.
_____	539078	Blank Post 5 in. x 5 in. x 78 in.
_____	539084	Blank Post 5 in. x 5 in. x 84 in.
_____	539090	Blank Post 5 in. x 5 in. x 90 in.
_____	539096	Blank Post 5 in. x 5 in. x 96 in.
_____	539108	Blank Post 5 in. x 5 in. x 107 in.
POSTS - BLANK: HEAVY WALL 5 IN. X 5 IN. POSTS		
_____	679096	Blank Post Heavy Wall 5 in. x 5 in. x 96 in.
_____	679108	Blank Post Heavy Wall 5 in. x 5 in. x 107 in.
_____	679132	Blank Post Heavy Wall 5 in. x 5 in. x 132 in.
FENCE PICKETS: 7/8 IN. X 1-1/2 IN. UNDRILLED PICKETS		
_____	319048	Picket 7/8 in. x 1-1/2 in. x 48 in.
_____	319060	Picket 7/8 in. x 1-1/2 in. x 59-5/8 in.
_____	319072	Picket 7/8 in. x 1-1/2 in. x 71-5/8 in.
_____	319096	Picket 7/8 in. x 1-1/2 in. x 96 in.
FENCE PICKETS: 7/8 IN. X 3 IN UNDRILLED PICKETS		
_____	349048	Picket 7/8 in. x 3 in. x 48 in.
_____	349060	Picket 7/8 in. x 3 in. x 59-5/8 in.
_____	349072	Picket 7/8 in. x 3 in. x 71-5/8 in.
_____	349096	Picket 7/8 in. x 3 in. x 96 in.
FENCE PICKETS: 7/8 IN. X 6 IN. RIBBED PICKET		
_____	359051	Picket 7/8 in. x 6 in. x 51-5/8 in. Ribbed
_____	359063	Picket 7/8 in. x 6 in. x 63-5/8 in. Ribbed
_____	359071	Picket 7/8 in. x 6 in. x 71-1/2 in. Ribbed
_____	359096	Picket 7/8 in. x 6 in. x 96 in. Ribbed

For colors, add color letters to item number: Almond (AL), Clay (C).

QUANTITY	PRODUCT NUMBER	DESCRIPTION		
RAILS - BLANK				
_____	289072	2 in. x 4 in. Blank (actual size 1-3/4 in. x 3-1/2 in.) x 71-1/2 in.		
_____	289096	2 in. x 4 in. Blank (actual size 1-3/4 in. x 3-1/2 in.) x 95-1/2 in.		
POST CAPS AND COVERS				
_____	70401	Post Base Trim Cover 4 in. x 4 in. (2 pc)		
_____	70450	Textured Finish Decorative Post Trim 4 in. x 4 in.		
_____	70484	Decorative New England Post Trim Cover 5 x 5		
_____	70480	Porch Post 4 in. x 4 in. Trim (4 pc)		
_____	70407	Porch Post 5 in. x 5 in. Trim (4 pc)		
_____	70409	Gothic Cap Ext 4 in. x 4 in.		
_____	70411	Flat Cap Int 4 in. x 4 in.		
_____	70492	Ball Cap 4 in. x 4 in.		
_____	70414	Flat Cap Ext 4 in. x 4 in.		
_____	70426	New England Cap 4 in. x 4 in.		
_____	70493	Ball Cap 5 in. x 5 in.		
_____	70416	Gothic Cap Ext 5 in. x 5 in.		
_____	70417	Flat Cap Int 5 in. x 5 in.		
_____	70418	Flat Cap Ext 5 in. x 5 in.		
_____	70427	New England Cap Ext 5 in. x 5 in.		
MISCELLANEOUS HARDWARE				
_____	60783P	Lock Rings (order 2 per rail) Qty: 24		
_____	70776P	5/16 in. x 3/4 in. Hex Washer Head Screw Qty: 100		
_____	70822P	3/4 in. Rail Plug Qty: 25		
_____	70798P	Bullet Clips Qty: 100		
_____	70787P	#8 x 1-1/2 in. Stainless Steel Screw Qty: 100		
_____	70791P	#8 x 3/4 in. Stainless Steel Screw Qty: 100		
_____	70792P	Snap Cap Washer Qty: 100		
_____	70793P	Snap Cap Qty: 100		
_____	70814	12 Picket Hardware Bag		
_____	71100P	Rebar Separator Clip (4 pair/bag)		
REINFORCEMENT CHANNEL				
_____	70074	Aluminum Channel (1-1/4 in.) 2 in. x 4 in. x 71 in.		
_____	70075	Aluminum Channel (1-1/4 in.) 2 in. x 4 in. x 95 in.		
_____	70192	Aluminum Reinforcement Channel x 92 in. for 3-1/2 in. Square Rail		
_____	70292	Aluminum Reinforcement Channel x 92 in. or 2 in. x 4 in. (optional)		
_____	70092	Steel Reinforcement Channel x 92 in. for 2 in. x 4 in. (required for top rail of WindZone system)		
_____	70090	Steel Reinforcement Channel x 92 in. for 2 in. x 6 in. Rail		
_____	70093F	Steel Reinforcement Channel x 90-3/4 in. for 1-1/2 in. x 5-1/2 in. Rail		
_____	70094	Steel Reinforcement Channel 92 in. Length for 2 in. x 6 in. Molded Galveston Mid Rail		

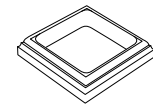

Decorative Base Trim



Tie-Down Trim



Ext Flat Cap



Int Flat Cap



Ball Cap



New England Cap



Gothic Cap



Snap Cap



Screw



Snap Cap Washer

Note: Reinforcement channel for routed rails: refer to appropriate fence style or railing style for application.

**Components
Post Caps**

Extruded

QUANTITY	PRODUCT NUMBER	DESCRIPTION
5 IN. SOLAR	CAP WITH 4 IN. ADAPTER	
_____	840031	Solar Post Cap with 4 in. Adapter (White)
_____	840032	Solar Post Cap with 4 in. Adapter (Black)



5 in. Solar Post
Cap with
4 in. Adapter

**Components
Mounting Brackets**

Extruded

QUANTITY	PRODUCT NUMBER	DESCRIPTION
MOUNTING BRACKETS (FOR ALTERNATE INSTALLATION METHODS)		
_____	71313	Wall Mount (7/8 in.) with Plate 2 in. x 4 in.
_____	71314	Wall Mount (7/8 in.) No Plate 2 in. x 4 in.
_____	71316	Wall Mount (1-1/4 in.) No Plate 2 in. x 4 in.
_____	71317	Wall Mount with Plate 2 in. x 6 in.
_____	71318	Wall Mount No Plate 2 in. x 6 in.
_____	71319	Wall Mount with Plate 1-1/2 in. x 5-1/2 in.
_____	71320	Wall Mount No Plate 1-1/2 in.
_____	71321	Wall Mount with Plate 1-1/2 in. x 1-1/2 in.

**Components
Mounting Brackets**

Extruded

WALL MOUNTING BRACKETS

PRODUCT NUMBER	DESCRIPTION & USAGE	DIMENSIONS				
		A	B	C	D	E
71313	Wall mount w/ plate (7/8") for 2 x 4 for use in all 2 x 4 rails that accept 7/8" pickets. Use also for traditional picket styles w/ 2 x 4 rails.	3"	5"	1-1/2"	1-1/2"	1-1/2"
71314	Wall mount w/ no plate (7/8") for 2 x 4 (same as above.)	-	-	1-1/2"	1-1/2"	1-1/2"
71316	Wall mount w/ no plate (1-1/4") for 2 x 4 for use in all 2 x 4 rails that accept 1-1/4" pickets.	-	-	1-1/4"	1-1/4"	2"
71317	Wall mount w/ plate for 2 x 6 use for 2 x 6 applications.	3"	7"	1-3/4"	1-3/4"	1-3/4"
71318	Wall mount w/ no plate for 2 x 6 (same as above)	-	-	1-3/4"	1-3/4"	1-3/4"
71319	Wall mount w/ plate 1-1/2" x 5-1/2" use with 1-1/2" x 5-1/2" rails.	2-1/2"	6-1/2"	1-1/4"	1-1/4"	1-1/8"
71320	Wall mount w/ no plate for 1-1/2" use with 1-1/2" x 5-1/2" or for 1-1/2" x 1-1/2" accent fence rails.	-	-	1-1/4"	1-1/4"	1-1/8"
71321	Wall mount w/ plate for 1-1/2" x 1-1/2" use for 1-1/2" x 1-1/2" accent rails.	2-1/2"	2-1/2"	1-1/4"	1-1/4"	1-1/8"

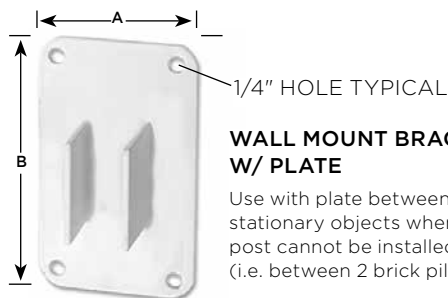

WALL MOUNT BRACKET W/ PLATE

Use with plate between 2 stationary objects when a vinyl post cannot be installed (i.e. between 2 brick pillars).



WALL MOUNT BRACKET W/ NO PLATE

Use wall mount bracket with no plate when attaching fence or railing to a wall and running into a vinyl post.

QUANTITY	PRODUCT NUMBER	DESCRIPTION
BLANK RAILS SMOOTH		
_____	289072P	Non-Routed (Blank) 2 in. x 4 in. x 71-1/2 in. Profile Qty: 138
_____	289096P	Non-Routed (Blank) 2 in. x 4 in. x 95-1/2 in. Profile Qty: 138
_____	289192P	Non-Routed (Blank) 2 in. x 4 in. x 192 in. Profile Qty: 138
_____	290095P	Lattice Accent Rail (Blank) 2 in. x 3-1/2 in. x 95 in. Qty: 120
_____	290144P	Non-Routed (Blank) 2 in. x 3-1/2 in. x 144 in. Profile Qty: 120
_____	290192P	Non-Routed (Blank) 2 in. x 3-1/2 in. x 192 in. Profile Qty: 120
_____	219074P	Non-Routed (Blank) 2-1/2 in. x 4 in. x 74-1/2 in. Profile Qty: 80
_____	569192NP	Non-Drilled (Blank) 1-1/2 in. x 5-1/2 in. x 192 in. Profile Qty: 104
_____	589192NP	Non-Drilled (Blank) 2 in. x 6 in. x 192 in. Profile Qty: 84
BLANK RAILS TEXTURED		
_____	909096P	Non-Routed (Blank) 2 in. x 4 in. x 95-1/2 in. Select Cedar Profile Qty: 138
_____	729095P	Non-Routed (Blank) 2 in. x 3-1/2 in. x 94-1/2 in. CertaGrain Profile Qty: 120
_____	719074P	Non-Routed (Blank) 2-1/2 in. x 4 in. x 74-1/2 in. CertaGrain Profile Qty: 80
PICKETS SMOOTH		
_____	319096P	7/8 in. x 1-1/2 in. x 96 in. Picket Qty: 506
_____	319144P	7/8 in. x 1-1/2 in. x 144 in. Picket Qty: 506
_____	319192P	7/8 in. x 1-1/2 in. x 192 in. Picket Qty: 506
_____	349096P	7/8 in. x 3 in. x 96 in. Picket Qty: 276
_____	349144P	7/8 in. x 3 in. x 144 in. Picket Qty: 276
_____	349192P	7/8 in. x 3 in. x 192 in. Picket Qty: 276
_____	359144P	7/8 in. x 6 in. x 144 in. Picket Qty: 196
_____	359192P	7/8 in. x 6 in. x 192 in. Picket Qty: 196
_____	469126P	7/8 in. x 7 in. x 125-5/8 in. Tongue and Groove Picket Qty: 138
_____	469192P	7/8 in. x 7 in. x 192 in. Tongue and Groove Picket Qty: 138
_____	479192P	5/8 in. x 11-3/8 in. x 192 in. Tongue and Groove Picket Qty: 128
_____	389144P	1-1/2 in. x 1-1/2 in. x 144 in. TW Picket Qty: 378
PICKETS TEXTURED		
_____	769126P	7/8 in. x 7 in. x 125-5/8 in. Tongue and Groove CertaGrain Picket Qty: 138
_____	929072P	7/8 in. x 3 in. x 71-5/8 in. Select Cedar Picket Qty: 480
POSTS SMOOTH		
_____	649075P	4 in. x 4 in. x 75 in. Post Qty: 60
_____	649084P	4 in. x 4 in. x 84 in. Post Qty: 60
_____	649090P	4 in. x 4 in. x 90 in. Post Qty: 60
_____	649096P	4 in. x 4 in. x 96 in. Post Qty: 60
_____	649144P	4 in. x 4 in. x 144 in. Post (White only) Qty: 60
_____	649192P	4 in. x 4 in. x 192 in. Post Qty: 60
_____	539078P	Regular Wall 5 in. x 5 in. x 78 in. Post Qty: 48
_____	539084P	Regular Wall 5 in. x 5 in. x 84 in. Post Qty: 48
_____	539096P	Regular Wall 5 in. x 5 in. x 96 in. Post Qty: 48
_____	539108P	Regular Wall 5 in. x 5 in. x 107 in. Post Qty: 48
_____	539192P	Regular Wall 5 in. x 5 in. x 192 in. Post Qty: 48
_____	679096P	Heavy Wall 5 in. x 5 in. x 96 in. Post Qty: 48
_____	679108P	Heavy Wall 5 in. x 5 in. x 107 in. Post Qty: 48
_____	679132P	Blank Post Heavy Wall 5 in. x 5 in. x 132 in. Qty: 48
POSTS TEXTURED		
_____	759096P	CertaGrain Privacy 5 ft. Blank Post 5 in. x 5 in. x 96 in. Qty: 48
_____	759108P	CertaGrain Privacy 6 ft. Blank Post 5 in. x 5 in. x 107 in. Qty: 48
END CHANNEL SMOOTH		
_____	17961P	End Channel 5/8 in. x 1 in. x 60-7/8 in. Qty: 768
_____	17991P	Lattice Channel 5/8 in. x 1 in. x 90-3/4 in. Qty: 768
_____	16959P	End Channel 7/8 in. x 1 in. x 59-7/8 in. Qty: 768
END CHANNEL TEXTURED		
_____	26960P	Textured End Channel 7/8 in. x 1 in. x 59 7/8 in. Qty: 768

Note: Not all profiles are available in all colors. Call for color availability and order requirements.

The routing template is primarily for use in the field. The kits contain a number of templates that allow the installer to rout a variety of holes that will accept the fence or railing profiles.

This system is ideal for situations which require stepping or racking, as well as transitions from one height or style to another.

In addition to the template kit, either a fixed base or a plunge router is required. The plunge router will require a 5/8" router template guide (purchase from your local tool dealer).

The fixed base router will require a 5/8" bearing (supplied in the template kit).

CAUTION!
Follow manufacturer's recommendations for safe operating procedures.

Important!
Routing templates have been specifically designed to be used with either a 5/8" bearing (fixed base router), or a 5/8" template guide (plunge router) and a 3/8" router blade with a 1/4" shank.

Any substitutions may result in an improper hole size or corner radius that could adversely affect the fit between the rail and post.

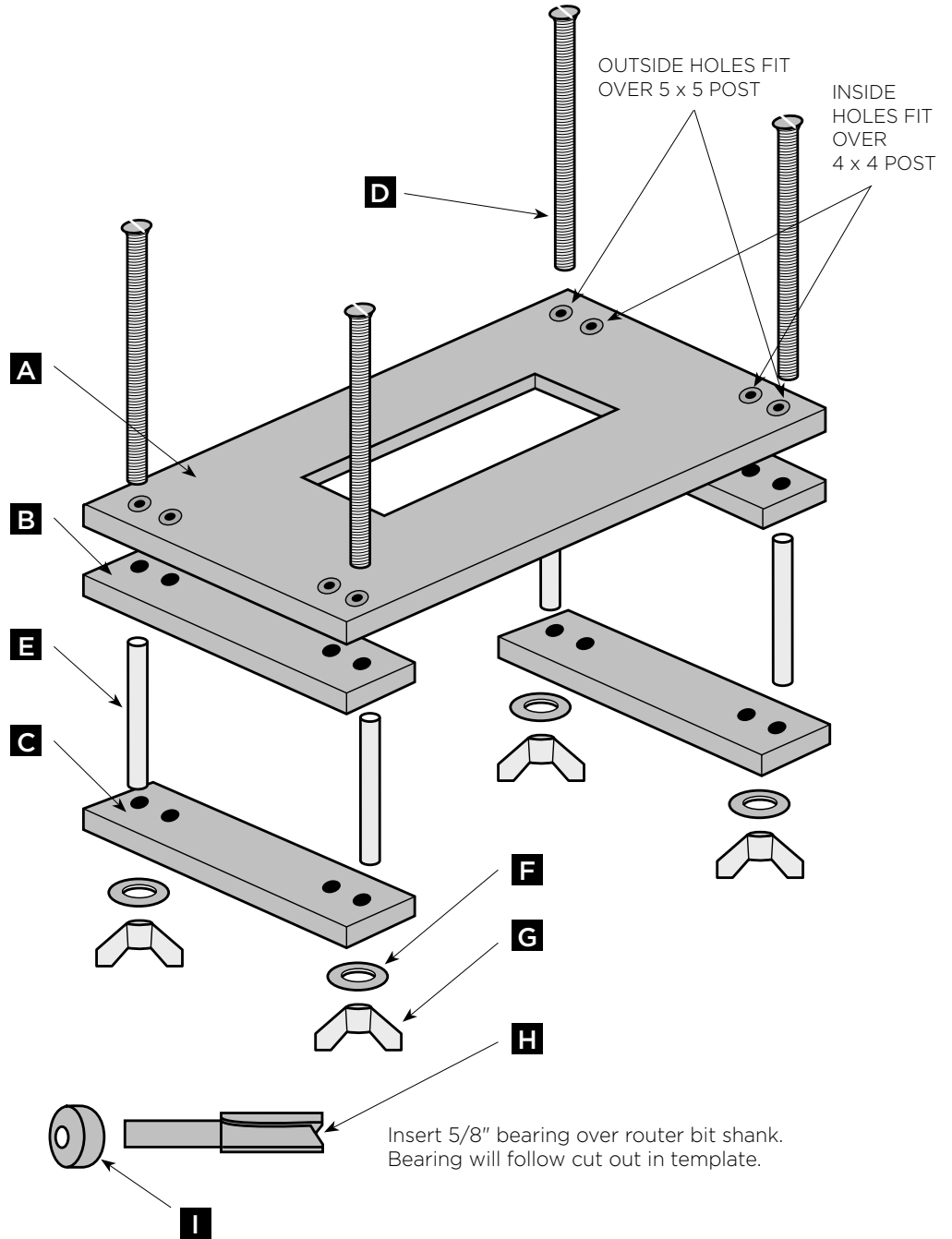

- A** ROUTING TEMPLATE
- B** 1-1/8" TEMPLATE SPACER PLATE
- C** 1-1/2" TEMPLATE SPACER PLATE
- D** 1/4" -20 x 6" BOLTS
- E** 3/8" OD PLEXI TUBE
- F** 1/4" FLAT WASHER
- G** 1/4" -20 WING NUT
- H** 3/8" ROUTER BIT W/ 1/4" SHANK
- I** 5/8" BEARING W/ 1/4" ID OPENING

QUANTITY	PRODUCT NUMBER	DESCRIPTION
_____	81041	Complete Routing Kit Package
_____	81044	Residential Routing Kit (9 black templates)
_____	81042	Agricultural Routing Kit (4 white templates)
_____	81063	Breezewood Template Kit (1 black template)

Note: Each template cut is designed to be 1/8 in. larger than the finished cut. This is to allow the template guide or bearing to follow the shape of the cut. Each kit comes in a carrying case suitable for field use.

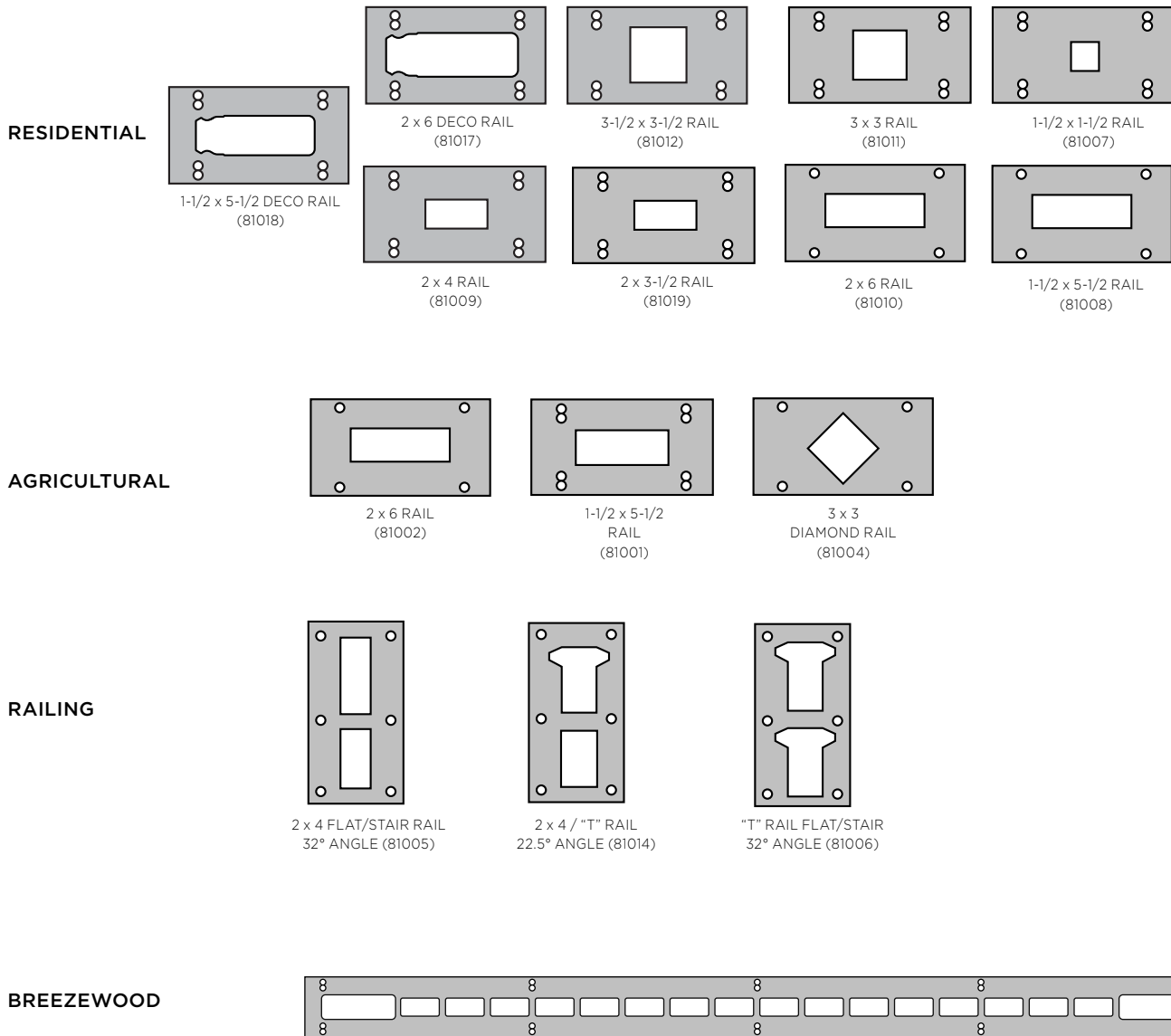

Each template cut out is designed to be 1/8" larger than the finished cut. This is to allow the template guide or bearing to follow the shape of the cut out.

Each kit comes in a carrying case suitable for field use

Before You Begin

Make Sure You Have All the Pieces You Need

1 POST SUPPORT KITS IN CONCRETE AND WOOD OPTIONS

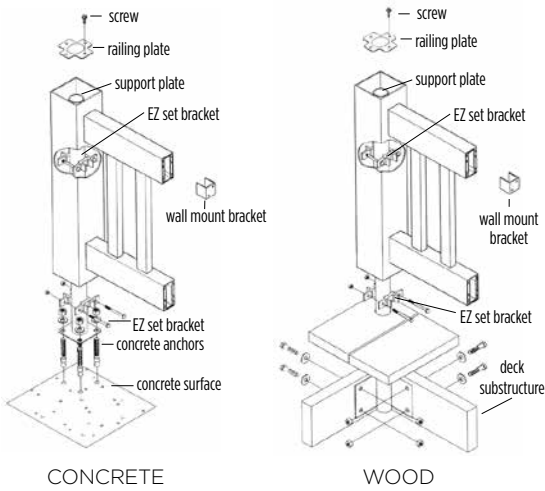

POST SUPPORT HEIGHT

Railing system	Flat	Stair
3' Wood	43-1/2"	54"
3' Concrete	37-1/2"	48"
3-1/2' Wood	49-1/2"	54"
3-1/2' Concrete	43-1/2"	48"

YOUR POST SUPPORT KIT SHOULD INCLUDE:
(WOOD POST SUPPORT KIT SHOWN FOR ILLUSTRATION)

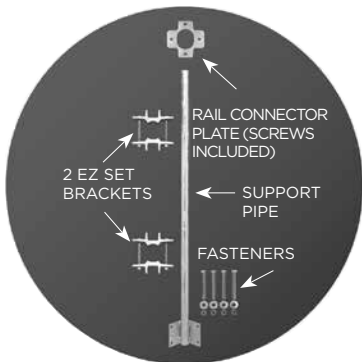

2 POSTS

FLAT

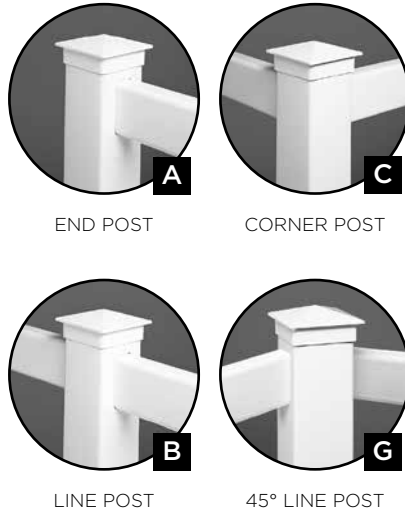

STAIR

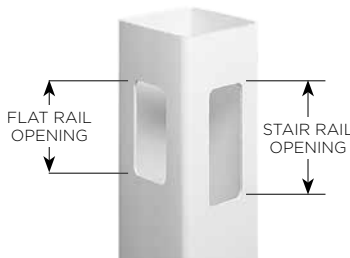
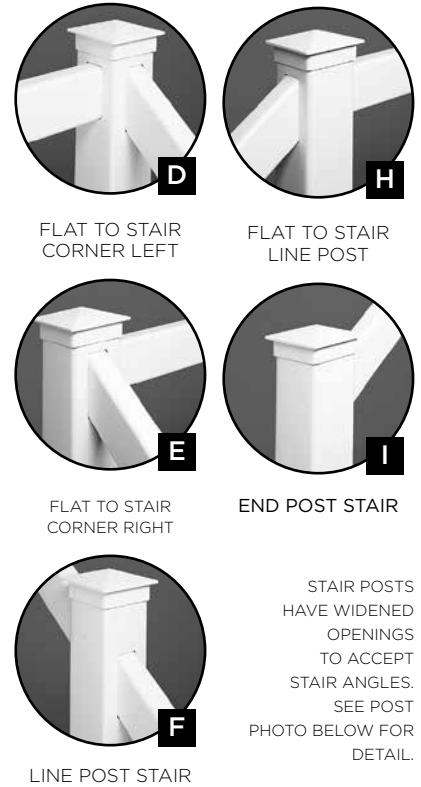

STAIR POSTS HAVE WIDENED OPENINGS TO ACCEPT STAIR ANGLES. SEE POST PHOTO BELOW FOR DETAIL.

3 RAILING BRACKETS

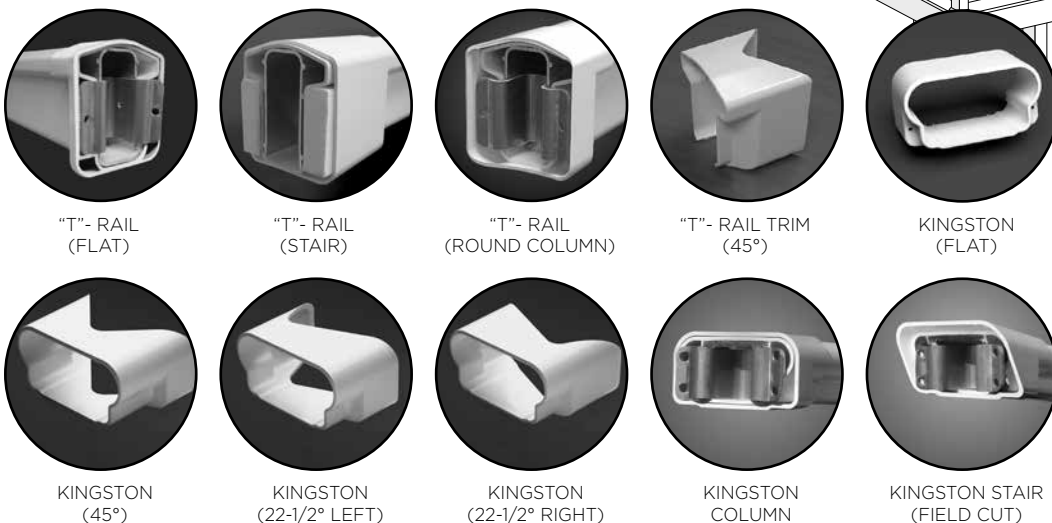

USE "I" POST AND ROUTER TEMPLATE

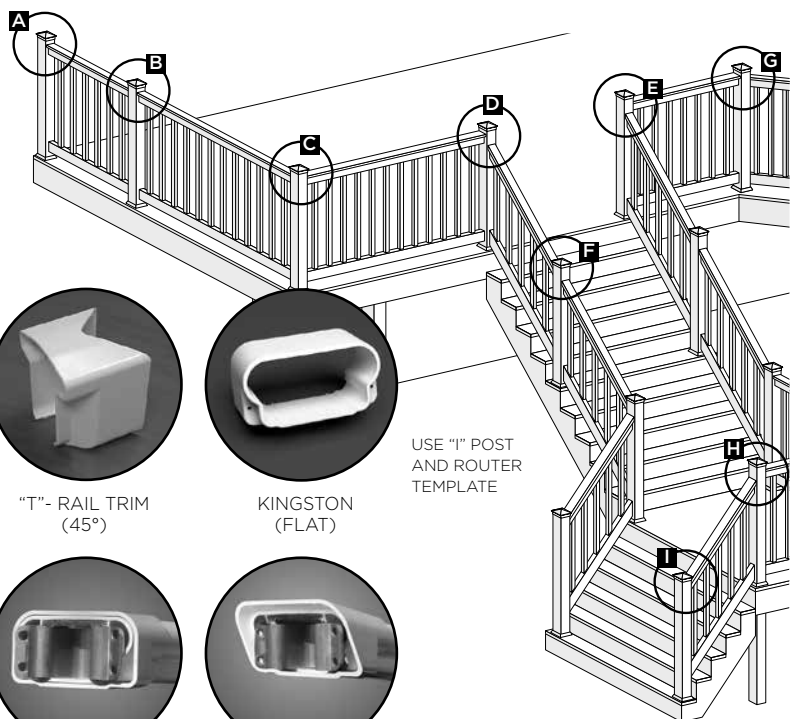

For colors, add color letters to item number: Almond (AL), Clay (C).

QUANTITY	PRODUCT NUMBER	DESCRIPTION
RAILING BOXED SECTION (includes A,B,C,D, E) Posts and caps sold separately.		
_____	285006	3 ft. x 6 ft. Kingston (Flat) Boxed Kit, Square Balusters
_____	285206	3 ft. x 6 ft. Kingston (Flat) Boxed Kit, Traditional Balusters
_____	285008	3 ft. x 8 ft. Kingston (Flat) Boxed Kit, Square Balusters
_____	285208	3 ft. x 8 ft. Kingston (Flat) Boxed Kit, Traditional Balusters
_____	285010	3 ft. x 10 ft. Kingston (Flat) Boxed Kit, Square Balusters
_____	285210	3 ft. x 10 ft. Kingston (Flat) Boxed Kit, Traditional Balusters

Note: Traditional balusters are only available in White and Almond.

ROUND ALUMINUM BALUSTER RAIL COMPONENT PACKS - For use with Round Aluminum Balusters (sold separately). Top and bottom rail only (hardware packs sold separately).

_____	286395	6 ft. Kingston Rail Pack - Use with Round Aluminum Balusters
_____	288395	8 ft. Kingston Rail Pack - Use with Round Aluminum Balusters

ROUND ALUMINUM BALUSTER COMPONENT PACKS - For use with Round Aluminum Baluster Rail Component Packs (sold separately). Includes 20-3/4 in. Round Aluminum Balusters (15 balusters/6 ft. section and 20 balusters/8 ft section).

_____	362033	33 in. Aluminum Baluster 3/4 in. Pack (20/pack), Round (Flat sections)
-------	--------	--

4 IN. X 4 IN. POSTS

_____	649538	Blank Post 4 x 4 x 38
-------	--------	-----------------------

POST CAPS (not available in all colors)

_____	70409	Gothic Cap Ext 4 in. x 4 in.
_____	70411	Flat Cap Int 4 in. x 4 in.
_____	70492	Ball Cap 4 in. x 4 in.
_____	70414	Flat Cap Ext 4 in. x 4 in.
_____	70426	New England Cap 4 in. x 4 in.

GATES (hardware included)

_____	631011	3 ft. Kingston Gate Kit, Square Balusters
_____	631012	3 ft. Kingston Gate Kit, Traditional Balusters
_____	631025	3 ft. Gate Kit for Round Aluminum Balusters (Balusters sold separately)

Note: Gate kits include (2) 2-1/2 in. x 4 in. up-rights, rails, balusters (Aluminum Balusters sold separately. 60 in. wide gate uses 11 balusters), caps, screws, hinges and latch.

POST SUPPORT KITS

_____	71450	Post Support Kit (Concrete), Flat 37-1/2 in. Height
_____	714610	Bracketed Post Support Kit (Concrete), Flat (37-1/2 in. actual height)
_____	714615	Mount 36 in. height (includes 4 in. molded PVC guides)
_____	714617	Mount Mounting Hardware for Wood and Composite Applications (includes: (4) 5/16-18x1 in bolts; (4) 5/16-18x6 in. bolts; (8) flat SAE washers; (4) #10x3/4 in. self-drilling screws; (1) post mount leveling plate; (4) 5/16-18 hex nuts; (1) bag of (16) #10x1.000 self-drilling screws; (1) instruction sheet)
_____	714618	Mount Mounting Hardware for Concrete Applications (includes: (4) 5/16-18x1" bolts; (8) flat SAE washers; (4) #10x3/4" self-drilling screws; (1) post mount leveling plate; (1) bag of (16) #10x1.000 self-drilling screws)
_____	71455	Post Support Kit (Wood), Flat 42-1/2 in. Height

Note: Kits include welded pipe and plate, E-Z Set brackets, railing plate and lock screws, concrete anchors (concrete mount) or bolts (wood mount), nuts and washers.

OPTIONAL/EXTRA MATERIAL

_____	704132	Kingston Rail Mount Bracket Pack, Flat
_____	704147	Kingston Rail Mount Bracket Pack, Column
_____	704145	Kingston Rail Mount Bracket Pack, 45 Degrees
_____	704143	Kingston Rail Mount Bracket Pack, 22-1/2 Degrees
_____	70401	Post Base Trim Cover 4 in. x 4 in. (2 pc)
_____	70450	Textured Finish Decorative Post Trim 4 in. x 4 in.

- A TOP RAIL**
 3-1/4" x 1-5/8" x 68-1/2"
 (6' wide)
 3-1/4" x 1-5/8" x 92-1/2"
 (8' wide)
 3-1/4" x 1-5/8" x 116-1/2"
 (10' wide)
 with aluminum channel.

- B PICKETS**
 13 pickets of
 1-1/2" x 1-1/2" x 33-1/4"
 per 6' section.
 18 pickets of
 1-1/2" x 1-1/2" x 33-1/4"
 per 8' section.
 23 pickets of
 1-1/2" x 1-1/2" x 33-1/4"
 per 10' section.

- C BOTTOM RAIL**
 3-1/4" x 1-5/8" x 68-1/2"
 (6' wide)
 3-1/4" x 1-5/8" x 92-1/2"
 (8' wide)
 3-1/4" x 1-5/8" x 116-1/2"
 (10' wide)
 with aluminum channel.

- D RAIL MOUNT BRACKETS**
 4 per section
E CRUSH BLOCK
 1 per section
 (packed with brackets).

- F POST**
 4" x 4" x 38"

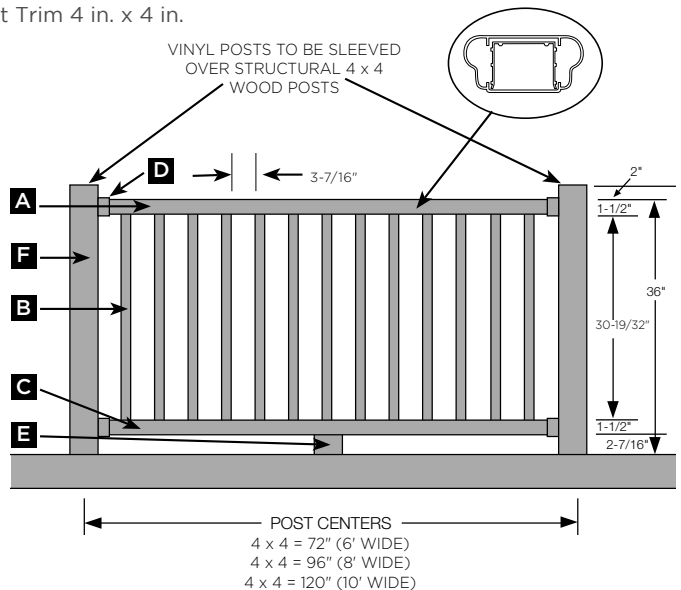

For colors, add color letters to item number: Almond (AL), Clay (C).

QUANTITY	PRODUCT NUMBER	DESCRIPTION
STAIR BOXED SECTION (includes A,B,C,D) Posts and caps sold separately.		
_____	286006	3 ft. x 6 ft. Kingston (Stair) Boxed Kit, Square Balusters
_____	286206	3 ft. x 6 ft. Kingston (Stair) Boxed Kit, Traditional Balusters
_____	286008	3 ft. x 8 ft. Kingston (Stair) Boxed Kit, Square Balusters
_____	286208	3 ft. x 8 ft. Kingston (Stair) Boxed Kit, Traditional Balusters
ROUND ALUMINUM BALUSTER RAIL COMPONENT PACKS - For use with Round Aluminum Balusters (sold separately). Top and bottom rail only (hardware packs sold separately).		
_____	286396	6 ft. Kingston Rail Pack - Use with Round Aluminum Balusters
_____	288396	8 ft. Kingston Rail Pack - Use with Round Aluminum Balusters
ROUND ALUMINUM BALUSTER COMPONENT PACKS - For use with Round Aluminum Baluster Rail Component Packs (sold separately). Includes 20-3/4 in. Round Aluminum Balusters (15 balusters/6 ft. section and 20 balusters/8 ft. section).		
_____	362031	31 in. Aluminum Baluster 3/4 in. Pack (20/pack), Round (Stair sections)
4 IN. X 4 IN. POSTS		
_____	649538	Blank Post 4 x 4 x 38
_____	649544	Blank Post 4 in. x 4 in. x 44 in.
POST CAPS (not available in all colors)		
_____	70409	Gothic Cap Ext 4 in. x 4 in.
_____	70411	Flat Cap Int 4 in. x 4 in.
_____	70492	Ball Cap 4 in. x 4 in.
_____	70414	Flat Cap Ext 4 in. x 4 in.
_____	70426	New England Cap 4 in. x 4 in.
POST SUPPORT KITS		
_____	71452	Post Support Kit (Concrete), Stair 48 in. Height
_____	71457	Post Support Kit (Wood), Stair 54 in. Height
<i>Note: Kits include welded pipe and plate, E-Z Set brackets, railing plate and lock screws, concrete anchors (concrete mount) or bolts (wood mount), nuts and washers.</i>		
OPTIONAL/EXTRA MATERIAL		
_____	704246	Kingston Rail Mount Bracket Pack, Stair/Steep Stair
_____	389218F	Square Baluster Replacement Pack, 39-1/4" (18 pc)
_____	371018F	Traditional Baluster Replacement Pack, 33-1/4" (18 pc)
_____	70401	Post Base Trim Cover 4 in. x 4 in. (2 pc)
_____	70450	Textured Finish Decorative Post Trim 4 in. x 4 in.

- A TOP RAIL**
 3-1/4" x 1-5/8" x 68-1/2" (6' wide)
 3-1/4" x 1-5/8" x 92-1/2" (8' wide)
 with aluminum channel.
- B BOTTOM RAIL**
 3-1/4" x 1-5/8" x 68-1/2" (6' wide)
 3-1/4" x 1-5/8" x 92-1/2" (8' wide)
 with aluminum channel.
- C PICKETS 32-1/2" BALUSTERS 33-1/4"**
 10 pieces of 1-1/2" x 1-1/2" x 33-1/4"
 per 6' section.
 14 pieces of 1-1/2" x 1-1/2" x 33-1/4"
 per 8' section.
- D STAIR RAIL MOUNT BRACKETS**
 4 per section.
- E POST**
 4" x 4" x 44"

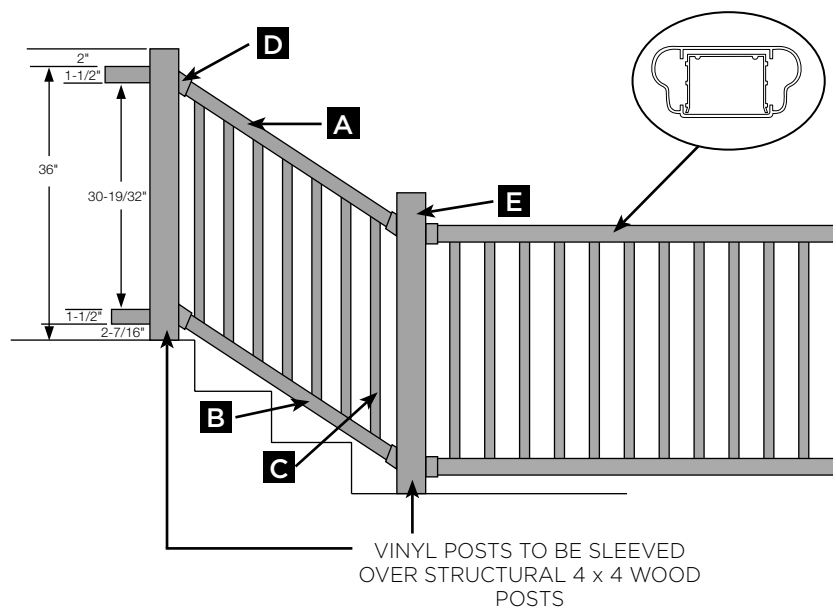

For colors, add color letters to item number: Almond (AL), Clay (C).

QUANTITY	PRODUCT NUMBER	DESCRIPTION
RAILING BOXED SECTION (includes A, B, C, D, E) Posts and caps sold separately.		
_____	285016	3-1/2 ft. x 6 ft. Kingston (Flat) Boxed Kit, Square Balusters
_____	285018	3-1/2 ft. x 8 ft. Kingston (Flat) Boxed Kit, Square Balusters
_____	285020	3-1/2 ft. x 10 ft. Kingston (Flat) Boxed Kit, Square Balusters
ROUND ALUMINUM BALUSTER RAIL COMPONENT PACKS - For use with Round Aluminum Balusters (sold separately). Top and bottom rail only (hardware packs sold separately).		
_____	286395	6 ft. Kingston Rail Pack - Use with Round Aluminum Balusters
_____	288395	8 ft. Kingston Rail Pack - Use with Round Aluminum Balusters
ROUND ALUMINUM BALUSTER COMPONENT PACKS - For use with Round Aluminum Baluster Rail Component Packs (sold separately). Includes 20-3/4 in. Round Aluminum Balusters (15 balusters/6 ft. section and 20 balusters/8 ft. section).		
_____	362039	39 in. Aluminum Baluster 3/4 in. Pack (20/pack), Round (Flat sections)
4 IN. X 4 IN. POSTS		
_____	649544	Blank Post 4 in. x 4 in. x 44 in.
POST CAPS (not available in all colors)		
_____	70409	Gothic Cap Ext 4 in. x 4 in.
_____	70411	Flat Cap Int 4 in. x 4 in.
_____	70492	Ball Cap 4 in. x 4 in.
_____	70414	Flat Cap Ext 4 in. x 4 in.
_____	70426	New England Cap 4 in. x 4 in.
GATES (hardware included)		
_____	631013	3-1/2 ft. Kingston Gate Kit, Square Balusters
_____	631026	3-1/2 ft. Gate Kit for Round Aluminum Balusters (Balusters sold separately)
<i>Note: Gate kits include (2) 2-1/2 in x 4 in. up-rights, rails, balusters (Aluminum Balusters sold separately. 60 in. wide gate uses 11 balusters), caps, screws, hinges and latch.</i>		
POST SUPPORT KITS		
_____	71451	Post Support Kit (Concrete), Flat 43-1/2 in. Height
_____	714611	Bracketed Post Support Kit (Concrete), Flat (43-1/2 in. actual height)
_____	71456	Post Support Kit (Wood), Flat 49-1/2 in. Height
_____	714616	Mount 42 in. height (includes 4" molded PVC guides)
_____	714617	Mount Mounting Hardware for Wood and Composite Applications (includes: (4) 5/16-18x1 in. bolts; (4) 5/16-18x6 in. bolts; (8) flat SAE washers; (4) #10x3/4 in. self-drilling screws; (1) post mount leveling plate; (4) 5/16-18 hex nuts; (1) bag of (16) #10x1.000 self-drilling screws; (1) instruction sheet)
_____	714618	Mount Mounting Hardware for Concrete Applications (includes: (4) 5/16-18x1" bolts; (8) flat SAE washers; (4) #10x3/4" self-drilling screws; (1) post mount leveling plate; (1) bag of (16) #10x1.000 self-drilling screws)
<i>Note: Kits include welded pipe and plate, E-Z Set brackets, railing plate and lock screws, concrete anchors (concrete mount) or bolts (wood mount), nuts and washers.</i>		
OPTIONAL/EXTRA MATERIAL		
_____	704132	Kingston Rail Mount Bracket Pack, Flat
_____	704147	Kingston Rail Mount Bracket Pack, Column
_____	704145	Kingston Rail Mount Bracket Pack, 45 Degrees
_____	704143	Kingston Rail Mount Bracket Pack, 22-1/2 Degrees
_____	70401	Post Base Trim Cover 4 in. x 4 in. (2 pc)
_____	70450	Textured Finish Decorative Post Trim 4 in. x 4 in.

- A TOP RAIL**
 3-1/4" x 1-5/8" x 68-1/2"
 (6' wide)
 3-1/4" x 1-5/8" x 92-1/2"
 (8' wide)
 with aluminum channel.
- B PICKETS**
 13 pickets of
 1-1/2" x 1-1/2" x 39-1/4"
 per 6' section.
 18 pickets of
 1-1/2" x 1-1/2" x 39-1/4"
 per 8' section.

- C BOTTOM RAIL**
 3-1/4" x 1-5/8" x 68-1/2"
 (6' wide)
 3-1/4" x 1-5/8" x 92-1/2"
 (8' wide)
 with aluminum channel.
- D RAIL MOUNT BRACKETS**
 4 per section.
- E CRUSH BLOCK**
 1 per section
 (packed with brackets).
- F POST**
 4" x 4" x 44"

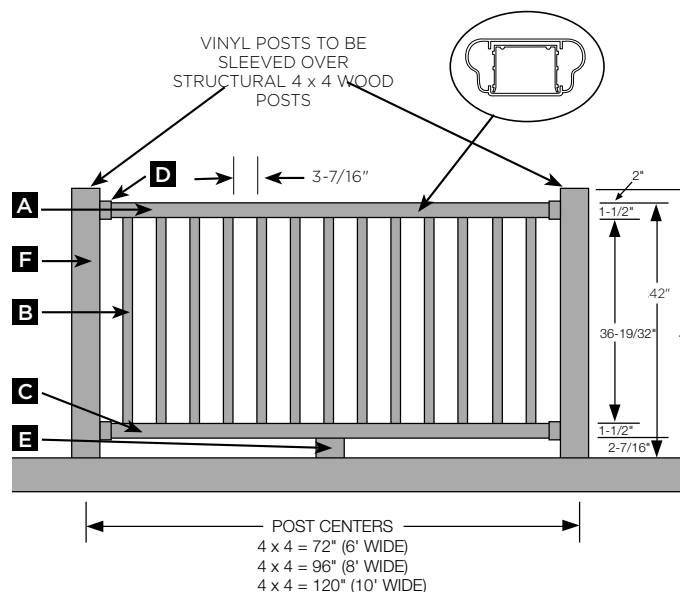

For colors, add color letters to item number: Almond (AL), Clay (C).

QUANTITY	PRODUCT NUMBER	DESCRIPTION
STAIR BOXED SECTION (includes A,B,C,D) Posts and caps sold separately.		
_____	286306	3-1/2 ft. x 6 ft. Kingston (Stair) Boxed Kit, Square Balusters
_____	286308	3-1/2 ft. x 8 ft. Kingston (Stair) Boxed Kit, Square Balusters
ROUND ALUMINUM BALUSTER RAIL COMPONENT PACKS - For use with Round Aluminum Balusters (sold separately). Top and bottom rail only (hardware packs sold separately).		
_____	286396	6 ft. Kingston Rail Pack - Use with Round Aluminum Balusters
_____	288396	8 ft. Kingston Rail Pack - Use with Round Aluminum Balusters
ROUND ALUMINUM BALUSTER COMPONENT PACKS - For use with Round Aluminum Baluster Rail Component Packs (sold separately). Includes 20-3/4 in. Round Aluminum Balusters (15 balusters/6 ft. section and 20 balusters/8 ft. section).		
_____	362037	37 in. Aluminum Baluster 3/4 in. Pack (20/pack), Round (Stair sections)
4 IN. X 4 IN. POSTS		
_____	649548	Blank Post 4 x 4 x 48
_____	649544	Blank Post 4 in. x 4 in. x 44 in.
POST CAPS (not available in all colors)		
_____	70409	Gothic Cap Ext 4 in. x 4 in.
_____	70411	Flat Cap Int 4 in. x 4 in.
_____	70492	Ball Cap 4 in. x 4 in.
_____	70414	Flat Cap Ext 4 in. x 4 in.
_____	70426	New England Cap 4 in. x 4 in.
POST SUPPORT KITS		
_____	71452	Post Support Kit (Concrete), Stair 48 in. Height
_____	71457	Post Support Kit (Wood), Stair 54 in. Height
<i>Note: Kits include welded pipe and plate, E-Z Set brackets, railing plate and lock screws, concrete anchors (concrete mount) or bolts (wood mount), nuts and washers.</i>		
OPTIONAL/EXTRA MATERIAL		
_____	704246	Kingston Rail Mount Bracket Pack, Stair/Steep Stair
_____	389218F	Square Baluster Replacement Pack, 39-1/4" (18 pc)
_____	70401	Post Base Trim Cover 4 in. x 4 in. (2 pc)
_____	70450	Textured Finish Decorative Post Trim 4 in. x 4 in.

- A TOP RAIL**
 3-1/4" x 1-5/8" x 68-1/2" (6' wide)
 3-1/4" x 1-5/8" x 92-1/2" (8' wide)
 with aluminum channel.
- B BOTTOM RAIL**
 3-1/4" x 1-5/8" x 68-1/2" (6' wide)
 3-1/4" x 1-5/8" x 92-1/2" (8' wide)
 with aluminum channel.
- C PICKETS** 39-1/4"
 10 pickets of 1-1/2" x 1-1/2" x 39-1/4"
 per 6' section.
 14 pickets of 1-1/2" x 1-1/2" x 39-1/4"
 per 8' section.
- D STAIR RAIL MOUNT BRACKETS**
 4 per section.
- E POST**
 4" x 4" x 44"

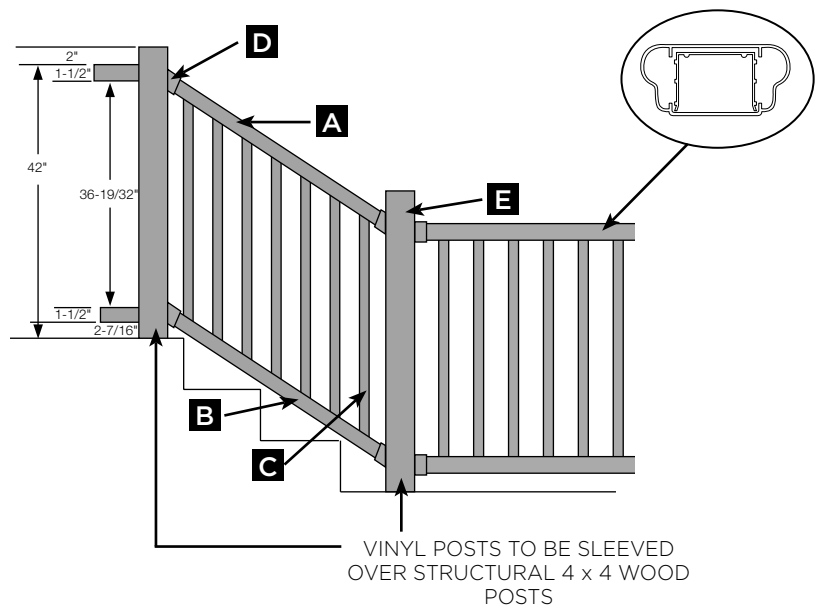

For colors, add color letters to item number: Almond (AL), Clay (C).

QUANTITY	PRODUCT NUMBER	DESCRIPTION
RAILING BOXED SECTIONS (includes A,B, C) Brackets, posts and caps sold separately.		
_____	20970	3 ft. x 6 ft. Oxford (Flat) Boxed Kit, Square Balusters
_____	20472	3 ft. x 6 ft. Oxford (Flat) Boxed Kit, Classic Balusters
_____	20978	3 ft. x 8 ft. Oxford (Flat) Boxed Kit, Square Balusters
_____	20480	3 ft. x 8 ft. Oxford (Flat) Boxed Kit, Classic Balusters
_____	20986	3 ft. x 10 ft. Oxford (Flat) Boxed Kit, Square Balusters (White only)
_____	20488	3 ft. x 10 ft. Oxford (Flat) Boxed Kit, Classic Balusters (White only)

Note: Classic balusters are only available in White and Almond.

ROUND ALUMINUM BALUSTER RAIL COMPONENT PACKS - For use with Round Aluminum Balusters (sold separately). Top and bottom rail only (hardware packs sold separately).

_____	28614	6 ft. Oxford Rail Pack, Flat
_____	28814	8 ft. Oxford Rail Pack, Flat

Note: Routed for 3/4 in. Round Aluminum Balusters

ROUND ALUMINUM BALUSTER COMPONENT PACKS - For use with Round Aluminum Baluster Rail Component Packs (sold separately). Includes 20-3/4 in. Round Aluminum Balusters (15 balusters/6 ft. section and 20 balusters/8 ft. section.)

_____	362033	33 in. Aluminum Baluster 3/4 in. Pack (20/pack), Round (Flat sections)
-------	--------	--

4 IN. X 4 IN, POSTS

_____	66151	Oxford Corner Post Flat 4 in. x 4 in. x 38 in.
_____	66152	Oxford Line Post Flat 4 in. x 4 in. x 38 in.
_____	66153	Oxford End Post Flat 4 in. x 4 in. x 38 in.
_____	649538	Blank Post 4 x 4 x 38
_____	66156	Oxford Line Post 45-Degree Line Post 4 in. x 4 in. x 38 in.

POST CAPS (not available in all colors)

_____	70409	Gothic Cap Ext 4 in. x 4 in.
_____	70411	Flat Cap Int 4 in. x 4 in.
_____	70492	Ball Cap 4 in. x 4 in.
_____	70414	Flat Cap Ext 4 in. x 4 in.
_____	70426	New England Cap 4 in. x 4 in.

GATES (gates utilize 2 in. x 4 in. top rails, hardware included)

_____	631021	3 ft. Oxford Gate Kit, Square Balusters
_____	631042	3 ft. Oxford Gate Kit, Classic Balusters
_____	631025	3 ft. Gate Kit for Round Aluminum Balusters (Balusters sold separately)

Note: Gate kits include (2) 2-1/2 in. x 4 in. up-rights, rails, balusters (Aluminum Balusters sold separately. 60 in. wide gate uses 11 balusters), caps, screws, hinges and latch.

POST SUPPORT KITS

_____	71450	Post Support Kit (Concrete), Flat 37-1/2 in. Height
_____	714610	Bracketed Post Support Kit (Concrete), Flat (37-1/2 in. actual height)
_____	71455	Post Support Kit (Wood), Flat 42-1/2 in. Height
_____	714615	Mount 36 in. height (includes 4 in. molded PVC guides)
_____	714617	Mount Mounting Hardware for Wood and Composite Applications (includes: (4) 5/16-18x1 in. bolts; (4) 5/16-18x6 in. bolts; (8) flat SAE washers; (4) #10x3/4 in. self-drilling screws; (1) post mount leveling plate; (4) 5/16-18 hex nuts; (1) bag of (16) #10x1.000 self-drilling screws; (1) instruction sheet)
_____	714618	Mount Mounting Hardware for Concrete Applications (includes: (4) 5/16-18x1" bolts; (8) flat SAE washers; (4) #10x3/4" self-drilling screws; (1) post mount leveling plate; (1) bag of (16) #10x1.000 self-drilling screws)

OPTIONAL/EXTRA MATERIAL

_____	71343	Oxford T-Rail Rail Mount Bracket 4-Pack, 45 Degree
_____	71344	Oxford T-Rail Rail Mount Bracket 2-Pack, Column
_____	71348	Oxford T-Rail Rail Mount Bracket 4-Pack, Flat/Line/Level
_____	70401	Post Base Trim Cover 4 in. x 4 in. (2 pc)
_____	70450	Textured Finish Decorative Post Trim 4 in. x 4 in.

A TOP RAIL

"T" rail x 71-1/2" (6' wide)
 "T" rail x 95-1/2" (8' wide)
 "T" rail x 119-1/2" (10' wide)
 with aluminum channel.

B PICKETS

14 pickets of 1-1/4" x 1-1/4" x 33-1/4" per 6' section.
 19 pickets of 1-1/4" x 1-1/4" x 33-1/4" per 8' section.
 24 pickets of 1-1/4" x 1-1/4" x 33-1/4" per 10' section.

C BOTTOM RAIL

2 x 4 x 71-1/2" (6' wide)
 2 x 4 x 95-1/2" (8' wide)
 2 x 4 x 119-1/2" (10' wide) with aluminum channel.

D POST

4" x 4" x 38"

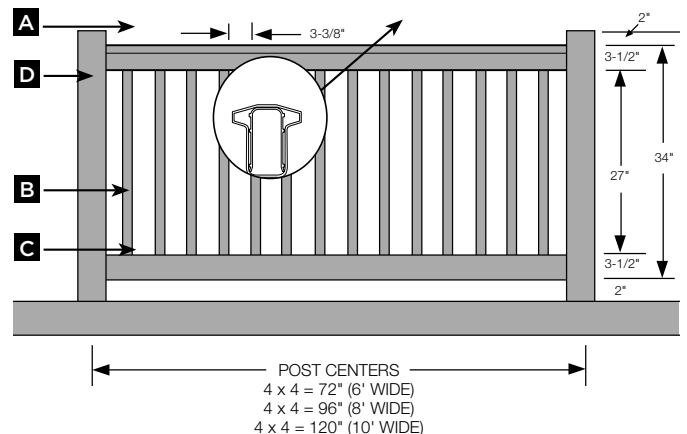
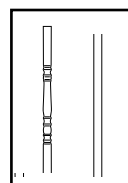

Railing Oxford Stair/Step

3 ft. High / 6 and 8 ft. Wide

Select one of the available colors
 ■ Almond ■ Clay ■ White

For colors, add color letters to item number: Almond (AL), Clay (C).

QUANTITY	PRODUCT NUMBER	DESCRIPTION
RAILING BOXED SECTIONS (includes A, B, C) Brackets, posts and caps sold separately.		
_____	20971	3 ft. x 6 ft. Oxford (Stair) Boxed Kit, Square Balusters
_____	20473	3 ft. x 6 ft. Oxford (Stair) Boxed Kit, Classic Balusters
_____	20979	3 ft. x 8 ft. Oxford (Stair) Boxed Kit, Square Balusters
_____	20481	3 ft. x 8 ft. Oxford (Stair) Boxed Kit, Classic Balusters
<i>Note: Classic balusters are only available in White and Almond.</i>		
ROUND ALUMINUM BALUSTER RAIL COMPONENT PACKS - For use with Round Aluminum Balusters (sold separately). Top and bottom rail only (hardware packs sold separately).		
_____	28617	6 ft. Oxford Rail Pack, Stair
_____	28818	8 ft. Oxford Rail Pack, Stair
ROUND ALUMINUM BALUSTER RAIL COMPONENT PACKS - For use with Round Aluminum Balusters (sold separately). Top and bottom rail only (hardware packs sold separately).		
_____	362031	31 in. Aluminum Baluster 3/4 in. Pack (20/pack), Round (Stair sections)
STEEP STAIR (WILL RACK UP TO 42 DEGREE ANGLE)		
_____	28393	Oxford 6 ft. Rail Pack, Steep Stair
_____	28394	Oxford 8 ft. Rail Pack, Steep Stair
_____	37159F	Square Baluster 6 ft. Pack, 37-3/4 in.
_____	37161F	Square Baluster 8 ft. Pack, 37-3/4 in.
4 IN. X 4 IN. POSTS		
_____	66252	Oxford Line Post Stair 4 in. x 4 in. x 48 in.
_____	66253	Oxford End Post Stair 4 in. x 4 in. x 48 in.
_____	66558	Oxford End Post Stair (inground) 4 in. x 4 in. x 75 in.
_____	649548	Blank Post 4 x 4 x 48
_____	64631L	Oxford Flat to Stair Corner Post Left 4 x 4 x 38
_____	64631R	Oxford Flat to Stair Corner Post Right 4 x 4 x 38
_____	64632	Oxford Flat to Stair Line Post 4 x 4 x 38
POST CAPS (not available in all colors)		
_____	70409	Gothic Cap Ext 4 in. x 4 in.
_____	70411	Flat Cap Int 4 in. x 4 in.
_____	70492	Ball Cap 4 in. x 4 in.
_____	70414	Flat Cap Ext 4 in. x 4 in.
_____	70426	New England Cap 4 in. x 4 in.
POST SUPPORT KITS		
_____	71452	Post Support Kit (Concrete), Stair 48 in. Height
_____	71457	Post Support Kit (Wood), Stair 54 in. Height
OPTIONAL/EXTRA MATERIAL		
_____	70401	Post Base Trim Cover 4 in. x 4 in. (2 pc)
_____	71349	Oxford T-Rail Rail Mount Bracket 4-Pack, Stair
_____	70450	Textured Finish Decorative Post Trim 4 in. x 4 in.

A TOP RAIL
 2" x 4" x 71-1/2" (6' wide)
 2" x 4" x 95-1/2" (8' wide)
 with aluminum channel.

B BOTTOM RAIL
 2" x 4" x 71-1/2" (6' wide)
 2" x 4" x 95-1/2" (8' wide)
 with aluminum channel.

C PICKETS
 11 pieces of 1-1/4" x 1-1/4" x 31-3/4"
 per 6' section.
 15 pieces of 1-1/4" x 1-1/4" x 31-3/4"
 per 8' section.

D POST
 4" x 4" x 48"

- 1** FLAT TO STAIR - line post, corner post.
- 2** STAIR/STEP - line post, end post.

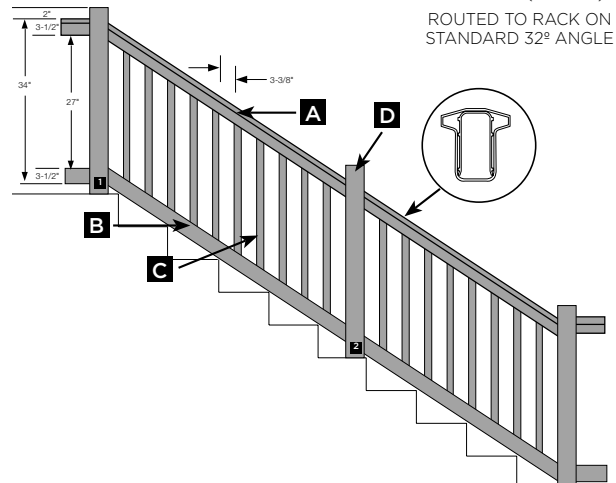
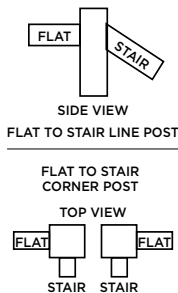
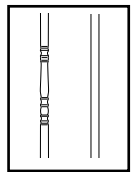

For colors, add color letters to item number: Almond (AL), Clay (C).

QUANTITY	PRODUCT NUMBER	DESCRIPTION
RAILING BOXED SECTIONS (includes A, B, C) Brackets, posts and caps sold separately.		
_____	20974	3-1/2 ft. x 6 ft. Oxford (Flat) Boxed Kit, Square Balusters
_____	20476	3-1/2 ft. x 6 ft. Oxford (Flat) Boxed Kit, Classic Balusters
_____	20982	3-1/2 ft. x 8 ft. Oxford (Flat) Boxed Kit, Square Balusters
_____	20484	3-1/2 ft. x 8 ft. Oxford (Flat) Boxed Kit, Classic Balusters
_____	20990	3-1/2 ft. x 10 ft. Oxford (Flat) Boxed Kit, Square Balusters (White only)
<i>Note: Classic balusters are only available in White and Almond.</i>		
ROUND ALUMINUM BALUSTER RAIL COMPONENT PACKS - For use with Round Aluminum Balusters (sold separately). Top and bottom rail only (hardware packs sold separately).		
_____	28614	6 ft. Oxford Rail Pack, Flat
_____	28814	8 ft. Oxford Rail Pack, Flat
ROUND ALUMINUM BALUSTER COMPONENT PACKS - For use with Round Aluminum Baluster Rail Component Packs (sold separately). Includes 20-3/4 in. Round Aluminum Balusters (15 balusters/6 ft. section and 20 balusters/8 ft. section).		
_____	362039	39 in. Aluminum Baluster 3/4 in. Pack (20/pack), Round (Flat sections)
GLASS BALUSTER RAILING		
_____	28513	Oxford 6 ft. Glass Rail Pack, Flat
_____	71370F	Glass Baluster 6 ft. Pack, 4 in. x 3/8 in. x 38-1/4 in., Flat and Stair (clear)
4 IN. X 4 IN. POSTS		
_____	66161	Oxford Corner Post 4 in. x 4 in. x 44 in.
_____	66162	Oxford Line Post 4 in. x 4 in. x 44 in.
_____	66163	Oxford End Post 4 in. x 4 in. x 44 in.
_____	649544	Blank Post 4 in. x 4 in. x 44 in.
_____	66166	Oxford Line Post 45-Degree Line Post 4 in. x 4 in. x 44 in.
POST CAPS (not available in all colors)		
_____	70409	Gothic Cap Ext 4 in. x 4 in.
_____	70411	Flat Cap Int 4 in. x 4 in.
_____	70492	Ball Cap 4 in. x 4 in.
_____	70414	Flat Cap Ext 4 in. x 4 in.
_____	70426	New England Cap 4 in. x 4 in.
POST SUPPORT KITS		
_____	71451	Post Support Kit (Concrete), Flat 43-1/2 in. Height
_____	714611	Bracketed Post Support Kit (Concrete), Flat (43-1/2 in. actual height)
_____	71456	Post Support Kit (Wood), Flat 49-1/2 in. Height
_____	714616	Mount 42 in. height (includes 4" molded PVC guides)
_____	714617	Mount Mounting Hardware for Wood and Composite Applications (includes: (4) 5/16-18x1 in. bolts; (4) 5/16-18x6 in. bolts; (8) flat SAE washers; (4) #10x3/4 in. self-drilling screws; (1) post mount leveling plate; (4) 5/16-18 hex nuts; (1) bag of (16) #10x1.000 self-drilling screws; (1) instruction sheet)
_____	714618	Mount Mounting Hardware for Concrete Applications (includes: (4) 5/16-18x1" bolts; (8) flat SAE washers; (4) #10x3/4" self-drilling screws; (1) post mount leveling plate; (1) bag of (16) #10x1.000 self-drilling screws)
GATES (gates utilize 2 in. x 4 in. top rails, hardware included)		
_____	631023	3-1/2 ft. Oxford Gate Kit, Square Balusters
_____	631044	3-1/2 ft. Oxford Gate Kit, Classic Balusters
_____	631026	3-1/2 ft. Gate Kit for Round Aluminum Balusters (Balusters sold separately)
<i>Note: Gate kits include (2) 2-1/2 in. x 4 in. up-rights, rails, balusters (Aluminum Balusters sold separately. 60 in. wide gate uses 11 balusters), caps, screws, hinges and latch.</i>		
OPTIONAL/EXTRA MATERIAL		
_____	70401	Post Base Trim Cover 4 in. x 4 in. (2 pc)
_____	71348	Oxford T-Rail Rail Mount Bracket 4-Pack, Flat/Line/Level
_____	71343	Oxford T-Rail Rail Mount Bracket 4-Pack, 45 Degree
_____	71344	Oxford T-Rail Rail Mount Bracket 2-Pack, Column
_____	70450	Textured Finish Decorative Post Trim 4 in. x 4 in.

- A TOP RAIL**
 "T" rail x 71-1/2" (6' wide)
 "T" rail x 95-1/2" (8' wide)
 "T" rail x 119-1/2" (10' wide with aluminum channel).
- B PICKETS**
 14 pieces of 1-1/4" x 1-1/4" x 39-1/4" per 6' section.
 19 pieces of 1-1/4" x 1-1/4" x 39-1/4" per 8' section.
 24 pieces of 1-1/4" x 1-1/4" x 39-1/4" per 10' section.

- C BOTTOM RAIL**
 2 x 4 x 95-1/2" (8' wide)
 2 x 4 x 119-1/2" (10' wide) with aluminum channel.

- D POST**
 4" x 4" x 44"

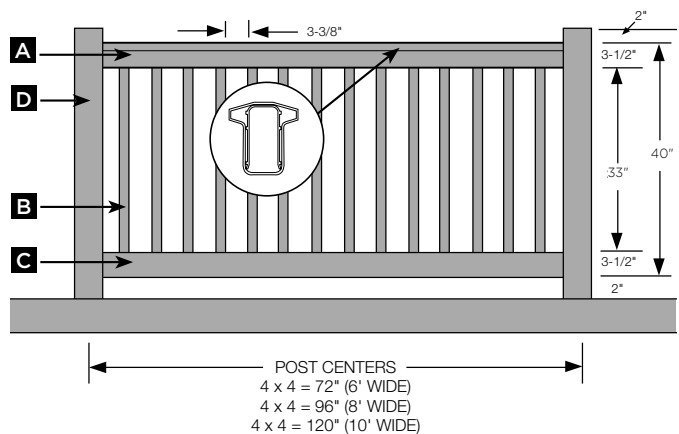
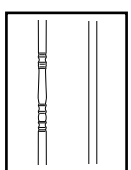

For colors, add color letters to item number: Almond (AL), Clay (C).

QUANTITY	PRODUCT NUMBER	DESCRIPTION
RAILING BOXED SECTIONS (includes A, B, C) Brackets, posts and caps sold separately.		
_____	20975	3-1/2 ft. x 6 ft. Oxford (Stair) Boxed Kit, Square Balusters
_____	20983	3-1/2 ft. x 8 ft. Oxford (Stair) Boxed Kit, Square Balusters
<i>Note: Colonial balusters are only available in White and Almond.</i>		
ROUND ALUMINUM BALUSTER RAIL COMPONENT PACKS - For use with Round Aluminum Balusters (sold separately). Top and bottom rail only (hardware packs sold separately).		
_____	28617	6 ft. Oxford Rail Pack, Stair
_____	28818	8 ft. Oxford Rail Pack, Stair
ROUND ALUMINUM BALUSTER COMPONENT PACKS - For use with Round Aluminum Baluster Rail Component Packs (sold separately). Includes 20-3/4 in. Round Aluminum Balusters (15 balusters/6 ft. section and 20 balusters/8 ft. section).		
_____	362037	37 in. Aluminum Baluster 3/4 in. Pack (20/pack), Round (Stair sections)
GLASS BALUSTER RAILING		
_____	28517	Oxford 6 ft. Rail Pack
_____	71370F	Glass Baluster 6 ft. Pack, 4 in. x 3/8 in. x 38-1/4 in., Flat and Stair (clear)
STEEP STAIR (WILL RACK UP TO 42 DEGREE ANGLE)		
_____	28393	Oxford 6 ft. Rail Pack, Steep Stair
_____	28394	Oxford 8 ft. Rail Pack, Steep Stair
_____	37159F	Square Baluster 6 ft. Pack, 37-3/4 in.
_____	37161F	Square Baluster 8 ft. Pack, 37-3/4 in.
4 IN. X 4 IN. POSTS		
_____	66462	Oxford Line Post Stair 4 in. x 4 in. x 51-1/2 in.
_____	66463	Oxford End Post Stair 4 in. x 4 in. x 51-1/2 in.
_____	66568	Oxford Inground End Post Stair 4 in. x 4 in. x 75 in.
_____	649552	Blank Post 4 x 4 x 52
_____	64641L	Oxford Flat to Stair Corner Post Left 4 x 4 x 44
_____	64641R	Oxford Flat to Stair Corner Post Right 4 x 4 x 44
_____	64642	Oxford Flat to Stair Line Post 4 x 4 x 44
POST CAPS (not available in all colors)		
_____	70409	Gothic Cap Ext 4 in. x 4 in.
_____	70411	Flat Cap Int 4 in. x 4 in.
_____	70492	Ball Cap 4 in. x 4 in.
_____	70414	Flat Cap Ext 4 in. x 4 in.
_____	70426	New England Cap 4 in. x 4 in.
POST SUPPORT KITS		
_____	71452	Post Support Kit (Concrete), Stair 48 in. Height
_____	71457	Post Support Kit (Wood), Stair 54 in. Height
OPTIONAL/EXTRA MATERIAL		
_____	70401	Post Base Trim Cover 4 in. x 4 in. (2 pc)
_____	71349	Oxford T-Rail Rail Mount Bracket 4-Pack, Stair
_____	70450	Textured Finish Decorative Post Trim 4 in. x 4 in.

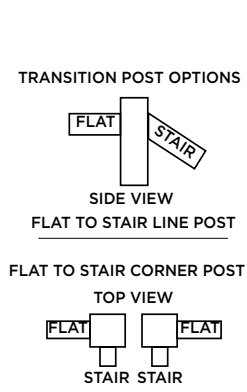

- A TOP RAIL**
 2" x 4" x 71-1/2" (6' WIDE)
 2" x 4" x 95-1/2" (8' WIDE)
 with aluminum channel.
- B BOTTOM RAIL**
 2" x 4" x 71-1/2" (6' WIDE)
 2" x 4" x 95-1/2" (8' WIDE)
 with aluminum channel.
- C PICKETS**
 11 pieces of 1-1/4" x 1-1/4" x 37-3/4"
 per 6' section.
 15 pieces of 1-1/4" x 1-1/4" x 37-3/4"
 per 8' section.
- D POST**
 4" x 4" x 51-1/2"
- 1** FLAT TO STAIR - line post, corner post.
- 2** STAIR/STEP - line post, end post.

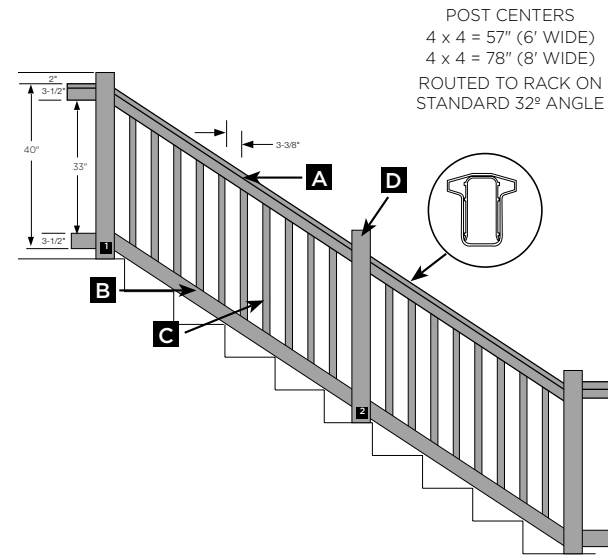

**Railing
Porch Posts/Columns**

Select one of the available colors
 ■ Almond ■ Clay ■ White

For colors, add color letters to item number: Almond (AL), Clay (C).

QUANTITY	PRODUCT NUMBER	DESCRIPTION
COLONIAL 4 IN. X 4 IN. PORCH POST (White, Almond)		
_____	73020	Colonial Porch Post 4 in. x 4 in. x 108 in.
SQUARE 5 IN. X 5 IN. PORCH POST (White, Almond, Clay)		
_____	73019	Square Porch Post 5 in. x 5 in. x 108 in.
COLONIAL 5 IN. X 5 IN. PORCH POST (White, Almond)		
_____	73017	Colonial Porch Post 5 in. x 5 in. x 108 in.
ACCESSORIES		
_____	70480	Porch Post 4 in. x 4 in. Trim (4 pc)
_____	70407	Porch Post 5 in. x 5 in. Trim (4 pc)
CERTA-SNAPWRAP KIT (includes 4 post wrap panels and 4 corner trims) White only		
_____	239001	Certa-SnapWrap 4 in. x 4 in. x 120 in. Kit (price is per kit) Box Qty 4 Kits
_____	239002	Certa-SnapWrap 6 in. x 6 in. x 120 in. Kit (price is per kit) Box Qty 2 Kits
<i>Note: 4 in. x 4 in. and 6 in. x 6 in. kits must be purchased in full box quantities.</i>		
CERTA-SNAPWRAP BASE TRIMS - SOLD SEPARATELY FROM KITS		
_____	70489	Certa-Snap Wrap 4 in. x 4 in. Trim Box Qty 80
_____	70497	Certa-Snap Wrap 6 in. x 6 in. Trim Box Qty: 40
8in. TAPERED PORCH COLUMN		
_____	73030	8 in. x 108 in. Round Column Tapered with Mounting Plates (White only)
_____	73035	Cap/Base Trim Set with Hardware - 8 in. Round Column Tapered (White only)
<i>Note: For complete post, order both Column and Trim set.</i>		
10 IN. TAPERED PORCH COLUMN		
_____	73031	10 in. x 108 in. Round Column Tapered with Mounting Plates (White only)
_____	73037	Cap/Base Trim Set with Hardware - 10 in. Round Column Tapered (White only)
<i>Note: For complete post, order both Column and Trim set.</i>		
8 IN. ROUND PORCH COLUMN		
_____	73032	8 in. x 108 in. Round Column Non-Tapered with Mounting Plates (White only)
_____	73036	Cap/Base Trim Set with Hardware - 8 in. Round Column Non-Tapered (White only)
<i>Note: For complete post, order both Column and Trim set.</i>		
8 IN. SQUARE PORCH COLUMN		
_____	73033	8 in. x 8 in. x 108 in. Square Column with Mounting Plates (White only)
_____	73038	Cap/Base Trim Set with Hardware - 8 in. Square Column (White only)
<i>Note: For complete post, order both Column and Trim set.</i>		
DECORATIVE POST SLEEVE		
_____	73046	Decorative Porch Post Cover 6 in. x 6 in. x 120 in.
_____	73047	Pyramid Post Cap 6 in. x 6 in.
_____	73048	4 Piece Post Sleeve Trim 6 in. x 6 in. (required when using post surface mount, requires field cutting)

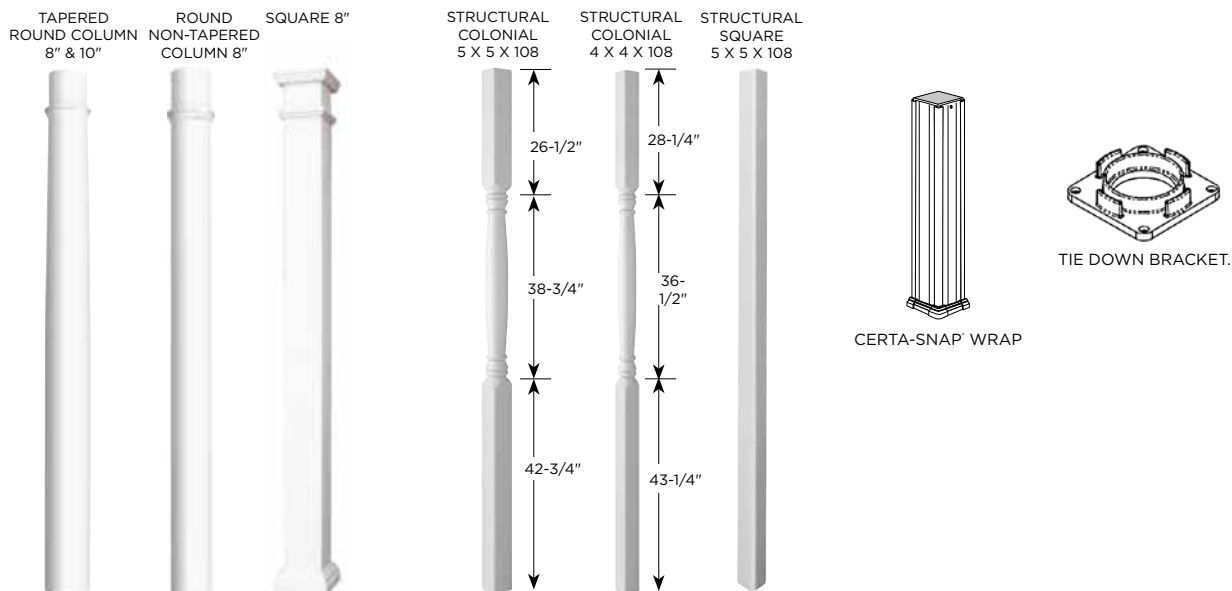

**Railing
Handrail**

Select one of the available colors
 Black White

For Black, add (BK) to item number.

QUANTITY	PRODUCT NUMBER	DESCRIPTION
_____	74028	RLG Handrail Bracket ASSY (10)
_____	74029	RLG Handrail EZ Post Attach (11)
_____	74083	RLG Handrail 180-Degree End Loop (4)
_____	74084	RLG Handrail 90-Degree CR (5)
_____	74085	RLG Handrail 90-Degree Post Return (6)
_____	74080	80 in. Aluminum Handrail (7)
_____	74104	104 in. Aluminum Handrail (8)
_____	74120	120 in. Aluminum Handrail (9)
_____	74089	End Cap (1)
_____	74081	Straight Wall Return (3)
_____	74070	Handrail Straight Joiner (2)
_____	74069	Handrail Joint Ring (12)
_____	74071	Handrail Inside Corner Bracket (13)
_____	74088	RLG Aluminum External Joiner (14)

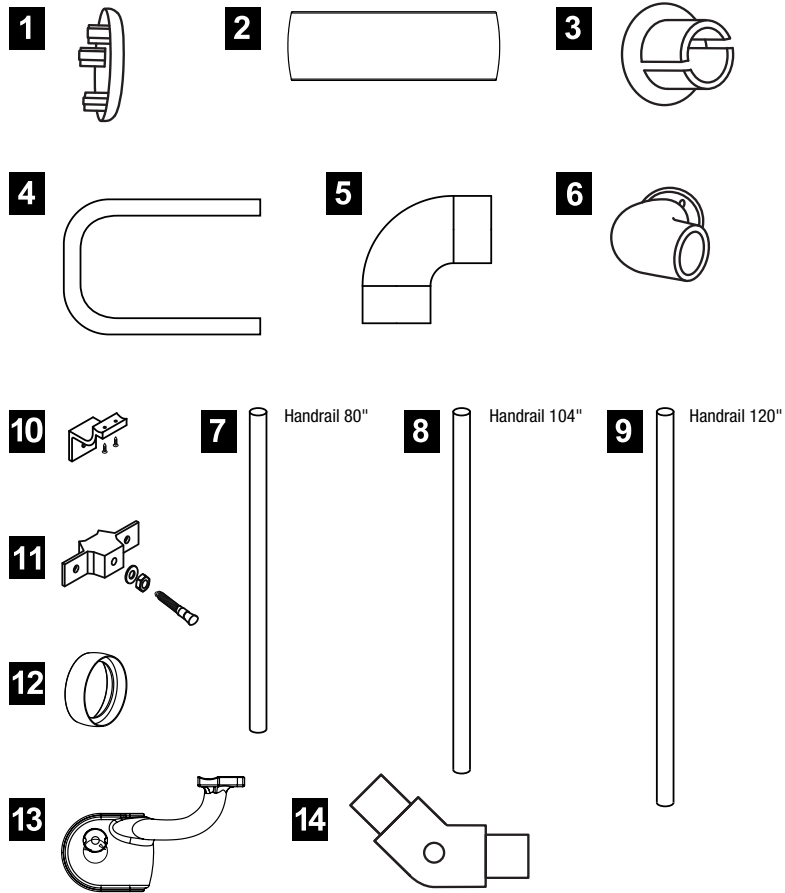

SPACING OF BRACKETS SHOULD BE A MAXIMUM OF 6' ON CENTER

For colors, add color letters to item number: Almond (AL), Grey (G).

QUANTITY	PRODUCT NUMBER	DESCRIPTION
DECK PLANK 1-1/2 IN. X 5-1/2 IN.		
_____	119145	Deck Plank x 145 in. (12 ft.)
_____	119193	Deck Plank x 193 in. (16 ft.) Minimum order quantity of 25
_____	119241	Deck Plank x 241 in. (20 ft.)
_____	70781P	Deck Screw #8 x 2-1/2 in. (order approx. 15 per 10 ft. of lineal plank) Qty: 100
_____	70783P	Deck Screw #8 x 2-1/2 in. Stainless Steel Qty: 100
FILL PIECE		
_____	129145	Fill Piece x 145 in. (12 ft.)
_____	129193	Fill Piece x 193 in. (16 ft.)
_____	129241	Fill Piece x 241 in. (20 ft.)
END COVER (C-SHAPED)		
_____	139144	End Cover x 144 in. (12 ft.)
_____	70820P	End Cover Fastener (25 pc) order approx. 1 per lineal foot
FASCIA PRODUCTS		
_____	359096	Picket 7/8 in. x 6 in. x 96 in. Ribbed
_____	349096	Picket 7/8 in. x 3 in. x 96 in.
_____	319096	Picket 7/8 in. x 1-1/2 in. x 96 in.
_____	70787P	#8 x 1-1/2 in. Stainless Steel Screw Qty: 100
_____	70792P	Snap Cap Washer Qty: 100
_____	70793P	Snap Cap Qty: 100
_____	70822P	3/4 in. Rail Plug Qty: 25

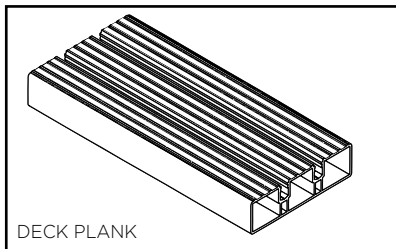

20' deck plank available in pallet quantity only as part of a full or 1/2 truckload of Bufftech products.

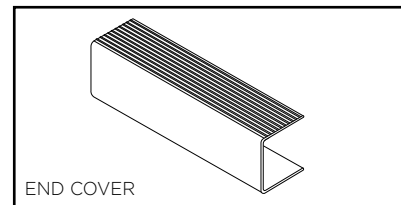

Can be scored & cut to form L-channel for trim

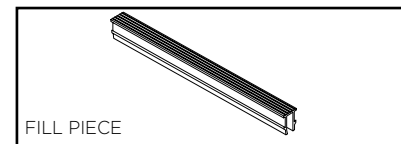

Estimated Material Cost Per Lineal Foot

You Should Know

This is a guideline only. It should be used as a reference and as an aid in selling CertainTeed EverNew Decking.

Formula

1. Calculate square footage of surface to cover with deck plank.
2. Multiply square footage x 2.18 to determine linear feet of **deck plank** required.
3. Multiply linear feet of plank x 2 to determine linear feet of **fill piece** required.
4. Measure linear footage of open ended plank to determine linear feet of **end cover** required.

Request for Material Estimate

QUOTATION DATE _____ COMPANY _____

CONTACT _____ STATE _____ ZIP CODE _____

PHONE _____ FAX _____

FENCE:

RESIDENTIAL:

STYLE _____ HEIGHT _____ COLOR _____ POST CAP _____

GATES: GATE KIT _____ PREASSEMBLED GATE _____

POST & RAIL: 2 RAIL _____ 3 RAIL _____ 4 RAIL _____ POST CAP _____

RAILS: 1-1/2 x 5-1/2 _____ 2 x 6 _____ COLOR _____

GATES: SINGLE _____ DOUBLE _____

RAILING: STYLE _____ HEIGHT _____ COLOR _____

POST CAP _____ POST TRIM _____

BALUSTER STYLE _____ BRACKETED _____ ROUTED _____

MOUNTING METHOD: SLEEVE OVER WOOD _____ CONCRETE _____ WOOD _____

LAYOUT

TOTAL FOOTAGE _____

Request for Deck Estimate

DATE _____ COMPANY _____

CONTACT _____ STATE _____ ZIP CODE _____

PHONE _____ FAX _____

REQUIRED INFORMATION

1. **COLOR OF DECKING:** WHITE GREY ALMOND (CIRCLE CHOICE)
2. **DIRECTION OF FLOOR JOISTS** (PLEASE DEMONSTRATE WITH ARROWS ON YOUR SKETCH)
3. **ANY STEPS?** Y N (CIRCLE CHOICE) **HOW MANY?** _____ **WIDTH OF STEP** _____
4. **RELATIONSHIP OF ATTACHED BUILDINGS TO THE DECK (IF ANY, PLEASE DEMONSTRATE)**
5. **IS FASCIA COVER REQUIRED?** Y N (CIRCLE CHOICE)
6. **HEIGHT OF REQUIRED FASCIA BOARD** _____

DECK LAYOUT

SPECIAL NOTES

- For quote purposes only, 12' or 16' planks are used.
- Decking must be laid in the opposite direction or diagonally to the direction of the joists.
- Deck screws required approx. 1-1/2 per linear foot and are sold in 100/pack.
- Standard deck screws are galvanized. Please specify if stainless are desired.
- Fill pieces required are 2 per length plank.
- End covers are quoted for exposed cut edges only.
- End cover fasteners required are 1 per linear foot of end cover.

Bufftech®

Extruded Products 800-333-0569

Molded Products 866-648-9336

www.bufftech.com



CertainTeed

CEILINGS • DECKING • FENCE • GYPSUM • INSULATION • RAILING • ROOFING • SIDING • TRIM

20 Moores Road, Malvern, PA 19355 Professional: 800-233-8990 Consumer: 800-782-8777 certainteed.com