

# CertaWrap™

Weather Resistant Barriers

**Installation  
Guidelines**

**CertainTeed**  
SAINT-GOBAIN

# Installation Guidelines

These instructions describe and illustrate the steps involved in installing CertainTeed CertaWrap™ Weather Resistant Barrier. Their purpose is to provide detailed information and how-to tips that will simplify the installation process. CertainTeed shall not accept any liability or responsibility under its written warranty for failure caused by application that does not meet the requirements for proper installation. These requirements are outlined throughout this book. Any deviations from these requirements should be addressed and approved in writing by CertainTeed Corporation.

## Safety

CertainTeed recommends that Builders, Contractors and Suppliers of Weather Resistant Barrier products store, handle, and install Weather Resistant Barrier materials in a manner that avoids damage to the product and/or the structure.

### Fire Safety

Owners and installers should take a few simple steps to protect Weather Resistant Barrier materials from fire.

### Home and Building Owners

CertaWrap is made from synthetic materials and may melt or burn when exposed to a significant source of flame or heat. Building owners, occupants, and outside maintenance personnel should always take normal precautions to keep sources of fire (such as barbecues) and combustible materials (such as dry leaves, mulch, and trash) away from Weather Resistant Barrier products.

### Building Trades, Specifiers, Professionals and Do-It-Yourself Installers

If CertaWrap is exposed to significant heat or flame, the Weather Resistant Barrier will soften, sag, melt or burn, and may thereby expose the material underneath. Exercise care when selecting underlayment materials as many underlayment materials are made from synthetic materials that may be combustible. Before installing CertaWrap, make sure you understand the fire properties of the underlayment materials. Install all building materials in accordance with local, state, provincial, and federal building codes and fire regulations.

### Slippage

While CertaWrap provides a highly slip resistant surface, it may become slippery in some conditions. Do not walk on

CertaWrap. We recommend using kick jacks or scaffolding for work above the first floor. If you must use a ladder, do not allow CertaWrap to fall on or around ladder steps. For more information about ladder safety, consult ANSI standard 14.1, 14.2, and 14.5 for ladders made of wood, aluminum, and fiberglass respectively.

## Transporting and Storing CertaWrap

Store CertaWrap indoors and away from direct sources of heat and sunlight. Storing products outside may result in damage. If you are transporting CertaWrap to a job site, keep the rolls flat and supported along their entire length.

At the job site, take the following precautions when storing CertaWrap:

- Store on a flat surface and support the entire length of the roll.
- Store the material away from areas where falling objects or other construction activity may cause damage.
- Do not store CertaWrap on black top pavement during unusually hot weather, under dark tarps or plastic wraps without air circulation, in unventilated storage trailers, or in any location where the temperature may exceed 130° F.

*Note: Take care when cutting the shrink wrap protecting CertaWrap, so as not to damage the roll inside.*

*Once you have installed CertaWrap Weather Resistant Barrier, apply cladding within 180 days for Premium or 90 days for Standard.*

## Fastening CertaWrap

To secure the Weather Resistant Barrier, use the appropriate recommended fasteners and fastening schedule for your application.

### Wood-based Sheathing

When attaching CertaWrap on wood-base sheathing, such as 7/16" OSB or 15/32" plywood, apply plastic-capped staples or plastic-capped nails every 32" vertically and horizontally.

### Open-stud Construction or Non-structural Sheathing

When attaching CertaWrap on open studs or non-structural sheathing, apply plastic-capped staples or plastic-capped nails long enough to penetrate the stud a minimum of 5/8" every 32" vertically and horizontally.

### Steel Framing

When installing CertaWrap over steel framing, use screws with minimum 1" diameter washers every 32" vertically and horizontally.

## STUDfinder™ Vertical Wall Installation Instructions

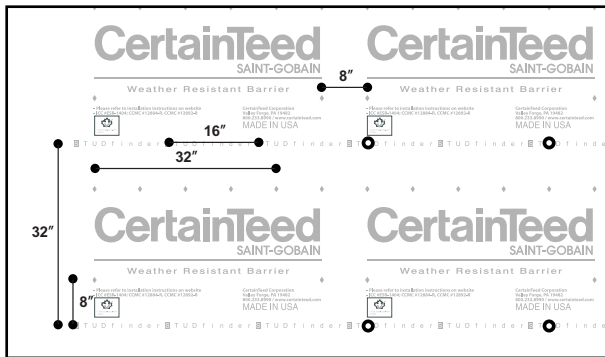

The STUDfinder Installation System combines precisely engineered fastening locations with graphics that help ensure quick, accurate, and secure installation. STUDfinder graphics are spaced at 1.6" intervals to guide accurate fastening both vertically and horizontally.

1. Install CertaWrap horizontally to exterior walls prior to the application of exterior cladding. Vertically position CertaWrap roll at the corner of the structure with the printed side out.

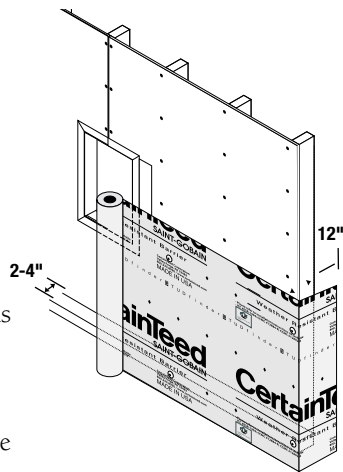

2. Locate the first stud and verify it is plumb. Align first stud with the nearest vertical STUDfinder line, allowing for a minimum 12" flap (305 mm) to wrap the corner for attachment to the adjoining wall. Extend the bottom edge of the CertaWrap 2-4" (51- 102 mm) over the sill plate. Apply plastic-capped staples or plastic-capped nails every 32" vertically along the first stud to secure the weather resistant barrier into position.



3. Unroll the CertaWrap along the exterior wall. Wrap CertaWrap completely around the building, covering window and door openings, plates, sills and corners.
4. To secure the Weather Resistant Barrier, use the fasteners and fastening schedule that is appropriate for your application.

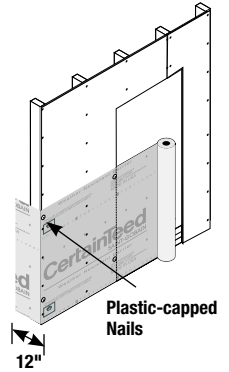

The STUDfinder marks will quickly guide you to your desired fastening location without the need for chalklines. Each letter is spaced 1.6" apart, and each series spans 16 inches. To achieve 32" spacing between fasteners, first locate the letter that the first row of fasteners covers. The second repeat of that letter is at 32".

Wood-based Sheathing	Open-stud Construction Non-structural Sheathing	Steel Framing
plastic-capped staples plastic-capped nails	plastic-capped staples plastic-capped nails	screws with minimum 1" diameter washers
every 32" vertically and horizontally	every 32" vertically and horizontally nails/staples must penetrate 5/8"	every 32" vertically and horizontally

5. Pull the CertaWrap snug and fasten it to the studs or sheathing and to the top and bottom plates.

6. When starting a new roll in the middle of a wall, overlap vertical and horizontal laps in the field a minimum of 6" (152 mm). When starting a new roll at an inside or outside corner, overlap vertical and horizontal seams a minimum of 12" (340 mm). All vertical and horizontal seams are to be installed in a weatherboard fashion. Lap CertaWrap over all existing flashings (e.g. z-flashing, roof-to-wall flashing, drip cap, et al.).

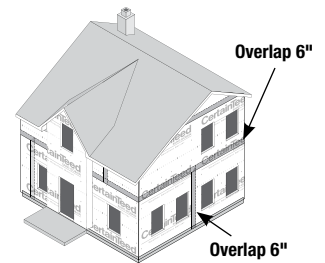

7. Flash or tape all vertical and horizontal seams and penetrations.

# STUDfinder™ Tilt Wall Installation Instructions

The STUDfinder\* Installation System combines precisely engineered fastening locations with graphics that help ensure quick, accurate, and secure installation. STUDfinder graphics are spaced at 1.6" intervals to guide accurate fastening both vertically and horizontally.

\*Note: STUDfinder is only printed on CertaWrap Premium.

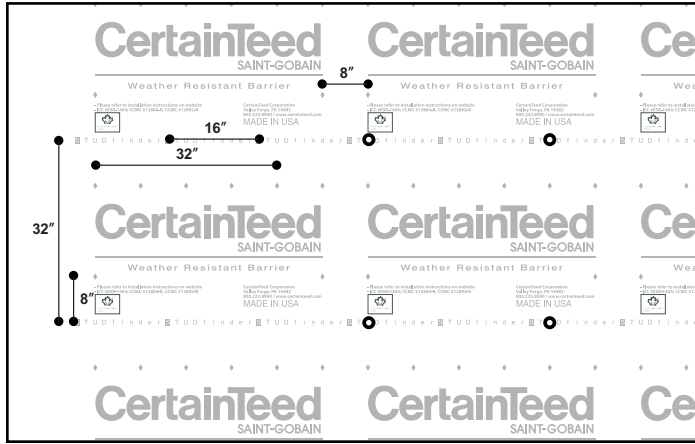

When you install CertaWrap Weather Resistant Barrier on tilt walls, follow these steps.

1. With the wall on the ground, cover the entire wall section with CertaWrap, aligning the guide marks on the Weather Resistant Barrier with the studs.

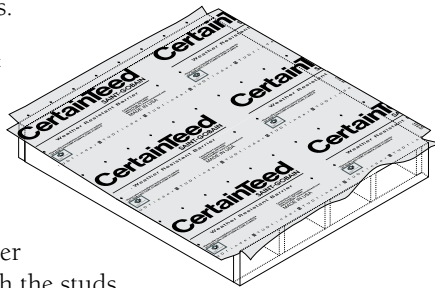

2. Allow a minimum of 6" (152 mm) of additional CertaWrap around the bottom and sides of the perimeter of each wall section for overlapping, while allowing a minimum of 12" (304 mm) of additional CertaWrap at all interior and exterior corners of the structure.
3. To secure the CertaWrap, use the fasteners and fastening schedule that are appropriate for your application.

Wood-based Sheathing	Open-stud Construction Non-structural Sheathing	Steel Framing
plastic-capped staples plastic-capped nails	plastic-capped staples plastic-capped nails	screws with minimum 1" diameter washers
every 32" vertically and horizontally	every 32" vertically and horizontally nails/staples must penetrate 5/8"	every 32" vertically and horizontally

The STUDfinder marks will quickly guide you to your desired fastening location without the need for chalklines. Each letter is spaced 1.6" apart, and each series spans 16". To achieve 32" spacing between fasteners, first locate the letter that the first row of fasteners covers.

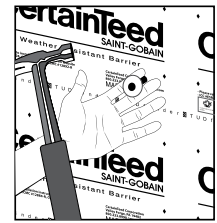

Move to the second repeat of that letter and you are at 32". For CertaWrap Standard, reference diamond indicators that are spaced 8" apart for guidance.

4. Raise and secure the wall sections, allowing the excess material on each section to overlap the bottom plates and corners.
5. Secure the overlap at the sides and bottom and tape all vertical and horizontal seams.

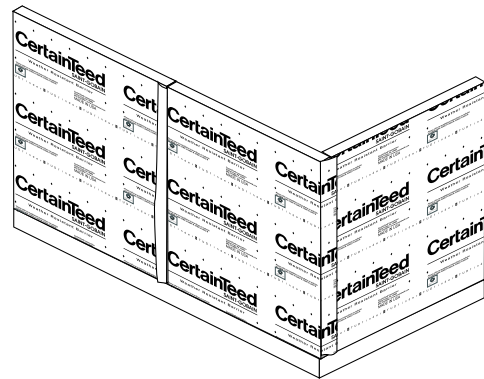

6. When starting a new roll in the middle of a wall, overlap vertical and horizontal laps in the field a minimum of 6" (152 mm). When starting a new roll at an inside or outside corner, overlap vertical and horizontal seams a minimum of 12" (340 mm). All vertical and horizontal seams are to be installed in a weatherboard fashion. Lap CertaWrap over all existing flashings (e.g. z-flashing, roof-to-wall flashing, drip cap, et al.).

## Flashing Penetrations

Seal the CertaWrap Weather Resistant Barrier around all electrical, HVAC, and plumbing penetrations with CertaTape™.

### Flashing Exterior Penetrations Without Flanges

If installing CertaWrap after all utility rough-ins have been completed, cut around the edge of the penetration to allow Weather Resistant Barrier to lay flat against the wall.

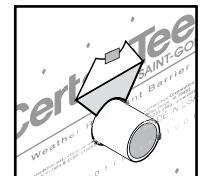

1. Make a 2", 45° cut at both the left and right side of the penetration, creating a flap. Fold back and secure flap temporarily above penetration.

2. Using window flashing, flash the base of the penetration where it meets the wall of the structure. Apply all flashing in a weatherboard fashion, beginning at the bottom of penetrations and working your way up.

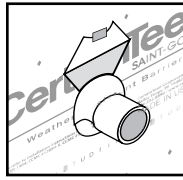

3. Unsecure flap, fold down into place and tape both edges of the flap with CertaTape to secure.

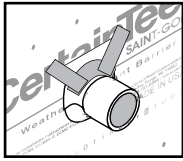

### Flashing Exterior Penetrations With Flanges

Exterior penetrations with flanges must be flashed prior to the installation of CertaWrap.

1. Cut a piece of CertaWrap 12" high and at least 18" wider than the flange-to-flange horizontal measurement of the widest point of the penetration. Insert this piece behind the bottom edge of the penetration.



2. Apply flashing in a weatherboards fashion to the bottom, sides, and top of the penetration covering the nailing flange completely as specified below:

a. Cut one piece of flashing that is 12" wider than the widest point of the flange-to-flange horizontal measurement of the bottom of the penetration. Apply the flashing at the bottom of the penetration, overlapping the flange.

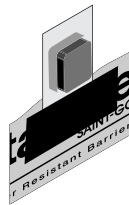

b. Cut two pieces of flashing 12" longer than the tallest point of the flange-to-flange vertical measurement of the sides of the penetration. Apply it at each side of the penetration, overlapping flange.



c. Cut one piece of flashing that is 12" wider than the widest point of the flange-to-flange horizontal measurement of the top of the penetration. Apply at the top of the penetration, overlapping flange.



3. Overlap the CertaWrap Weather Resistant Barrier onto the flashed penetration, cutting a hole to accommodate the penetration.

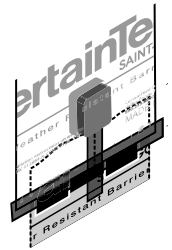

4. Beneath the center of the penetration, make a 6" vertical cut. At the bottom edge of the vertical cut, make a horizontal cut wide enough to accommodate the flap created in step 1.

5. Insert the bottom edge of the Weather Resistant Barrier piece you cut in step 1 through the opening you created in step 4.

6. Tape the penetration, first horizontally then vertically, in a weatherboards fashion.

## Installing CertaWrap Around Windows and Doors

### New Construction/New Windows

1. Cut a horizontal line in the Weather Resistant Barrier across the top of the window opening.

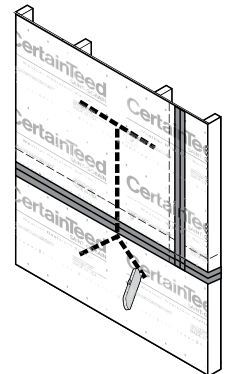

2. Start at the top center and make a vertical cut running two-thirds of the way down the opening.

3. From that stopping point, cut diagonally from both the lower right and left corners, creating an inverted or upside down "Y". This "Y" cut will make three CertaWrap flaps.

4. Pull each of the flaps tightly inside the rough opening and attach them to the frame with nails, staples, or tape.

5. Now install the window or door according to the manufacturer's instructions. The final step is to tape or flash all seams and flanges securely.

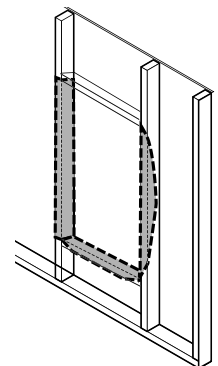

### Existing Windows

If windows and doors are already installed, flash according to the flashing installation guidelines. Then trim CertaWrap close to the flange area and seal with CertaTape.

## Installing Flashing

### Tools

- Caulk Gun
- Utility Knife or Scissors
- Gloves
- J-Roller

### Surface Preparation

- The substrate must be smooth, clean, dry and free of defects; otherwise it will adversely affect the installation and adhesion of flashing.
- Clean loose dust or dirt from the surface wherever flashing is to be applied by wiping with a clean, dry cloth or brush. The surface must be smooth and free from nails or staple heads, uncured solvents, and silicone caulk.
- For best adhesion, prime OSB, plywood, and cement surfaces with primers such as 3M™ Super 77™.

### Application Instructions

- Apply flashing at temperatures above 40° F during clear weather conditions. In low temperature conditions, use a heat gun or primer to improve adhesion.
- Do not apply flashing to flexible vinyl surfaces. Rigid PVC is acceptable.
- For good bonding, apply pressure on the flashing with a J-roller.
- When applying flashing, remove all wrinkles and bubbles.

## Installing Flashing Around a Rectangular Window

To install flashing around a rectangular opening:

1. Make diagonal cuts in the weather-resistant barrier at the upper corners of the top (head) of the rough opening. Gently lift and tape the flap temporarily in place.
2. Cut a piece of flashing for the bottom (sill) that is 12" longer than the width of the rough opening. Remove the backer from the flashing and begin applying one end to the jamb of the rough opening 6" above the sill. (NOTE: the tape will extend over the exterior edge of the jamb.) Applying even pressure to the tape with your hands, work your way down the jamb, across the sill, and up the opposite jamb, finishing 6" above the sill. Flex the overhanging tape down onto the wall covering the weather resistant barrier in weatherboards fashion, again applying even pressure to ensure adhesion.
3. Before installing the window, apply a continuous bead of sealant to the interior of the window's mounting flange. Install the window according to the manufacturer's instructions.

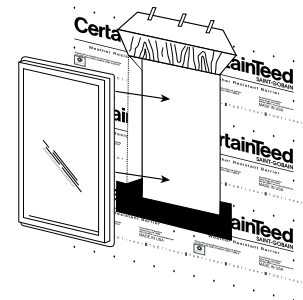
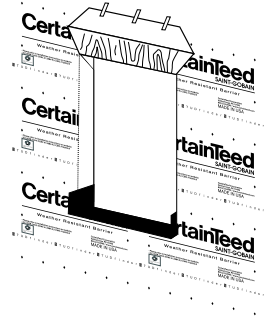
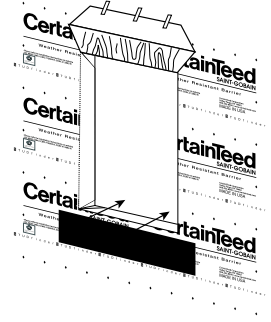

*Note: Flashing should be installed in accordance with the window manufacturer's instructions and in compliance with ASTM 2112.*

4. Cut two strips of flashing for the sides (jamb) of the window. Jamb flashing tape should extend a minimum of 3" above the top of the jambs of the window unit and a minimum of 1" beyond the bottom flashing tape installed in step #2, covering the width of the previously installed flashing at the base. Slowly peel release paper off as you press the flashing in place. Ensure the flashing covers all nails and mounting slots on the window's mounting flange.

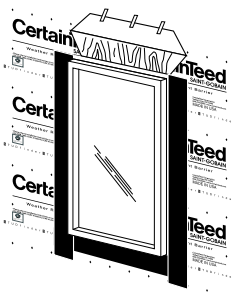

5. Cut flashing for the top (head) of the opening so it will extend beyond both ends of the jamb flashing. Ensure the flashing covers all nails and mounting slots on the window's mounting flange.

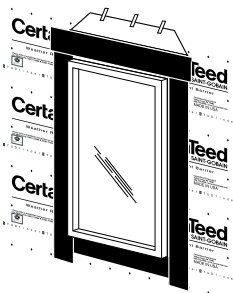

6. Finally, lay weather resistant barrier over the head flashing. Apply CertaTape over both diagonal cuts.

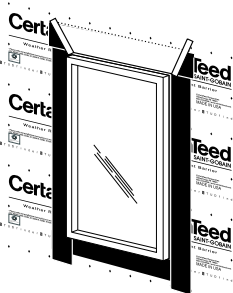

### Installing Flashing Around a Geometric Window

To install flashing around a geometric window or other round opening:

1. Cut horizontal slits where the curve starts on the window, out to a distance equal to the width of the flashing that will be used. From there, continue cutting at a 45° angle upwards until you are above the top center of the window by at least the width of the flashing. Temporarily tape this flap up out of the way.

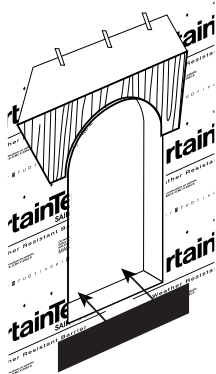

2. Cut a piece of flexible flashing for the bottom (sill) that is 12" longer than the width of the rough opening. Remove the backer from the flashing and begin applying one end to the jamb of the rough opening 6" above the sill. (NOTE: the tape will extend over the exterior edge of the jamb.) Applying even pressure to the tape with your hands, work your way down the jamb, across the sill, and up the opposite jamb, finishing 6" above the sill. Flex the overhanging tape down onto the wall covering the CertaWrap in weatherboards fashion, again applying even pressure to ensure adhesion.

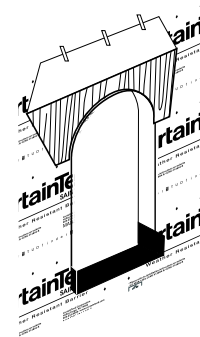

3. Apply a continuous bead of sealant to CertaWrap where interior of window's mounting flange will be applied. Install window per manufacturer's instructions.

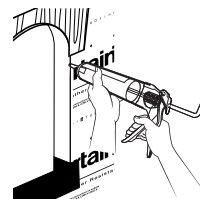

4. Cut two strips of flashing for the sides (jambs) of the window. The jamb flashing tape should extend a minimum of 3" above the horizontal mullion of the upper and lower window units, and a minimum of 1" beyond the bottom flashing tape installed in step #2. It should cover the width of the previously installed flashing at the base. Slowly peel off the release paper as you press the flashing in place. Ensure that the flashing covers all nails and mounting slots on the window's mounting flange.

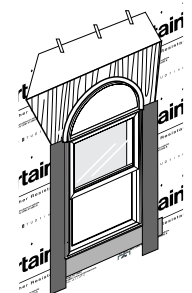

5. Cut a piece of flexible flashing for the head of the window. The tape should be cut to the length of the curve, plus twice the width of the flashing. Slowly peel the release paper and press the edge next to the window frame. Cover all nails and mounting slots.

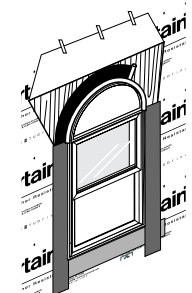

6. Fold down the flap (from step #1) over the head flashing, and tape the horizontal and diagonal slits in weatherboards fashion with CertaTape.

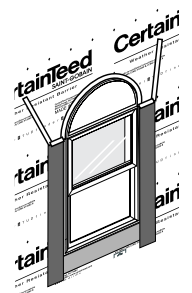

### For More Information

Complete instructions for installing all CertainTeed products are available from your local distributor, at [www.certainteed.com](http://www.certainteed.com), or by calling our Sales Support Group at 800-233-8990.



**CertainTeed Corporation**

20 Moores Road  
Malvern, PA 19355  
[www.certainteed.com](http://www.certainteed.com)

**ASK ABOUT ALL OF OUR OTHER CERTAINTEED® PRODUCTS AND SYSTEMS:**

ROOFING • SIDING • TRIM • DECKING • RAILING • FENCE  
GYPSUM • CEILINGS • INSULATION

Professional: 800-233-8990 Consumer: 800-782-8777